



US00D348349S

United States Patent [19]

[11] Patent Number: **Des. 348,349**

Blackwell

[45] Date of Patent: **** Jul. 5, 1994**

[54] **VISOR**

[76] Inventor: **Rebecca H. Blackwell**, 8015 Coronet Dr., Pensacola, Fla. 32514

[**] Term: **14 Years**

[21] Appl. No.: **5,403**

[22] Filed: **Mar. 3, 1993**

Related U.S. Application Data

[63] Continuation-in-part of Ser. No. 711,733, Jun. 7, 1991, abandoned.

[52] U.S. Cl. **D2/872; D2/876**

[58] Field of Search **D2/893, 876, 872; 2/12, 2/177, 206, 195.1, 209.3; 446/27; D21/188**

[56] **References Cited**

U.S. PATENT DOCUMENTS

D. 180,052	4/1957	Young .	
D. 237,758	11/1975	Huffman	D2/876
D. 267,752	2/1983	Fairbrother	D2/876
2,907,138	10/1959	Kolwicz .	
4,747,164	5/1988	Foulke .	
4,969,213	11/1990	Gruneisen .	
5,177,812	1/1993	Demars	362/105 X

OTHER PUBLICATIONS

Walt Disney Merchandise 1947-1948 p. 44 Middle Mickey Mouse.

Metal Impressions Inc. Brochure/catalog 1979.

Primary Examiner—Bernard Ansher

Assistant Examiner—Paula Mortimer

Attorney, Agent, or Firm—Richard C. Litman

[57] **CLAIM**

The ornamental design for a visor, as shown and described.

DESCRIPTION

FIG. 1 is a front perspective view of a visor showing my new design;

FIG. 2 is a right side elevational view with the left side being a mirror image thereof;

FIG. 3 is a front elevational view thereof;

FIG. 4 is a rear elevational view thereof;

FIG. 5 is a top view thereof; and,

FIG. 6 is a bottom view thereof.

The broken lines showing of a user's head in FIG. 1 is for illustrative purposes only and forms no part of the claimed design.

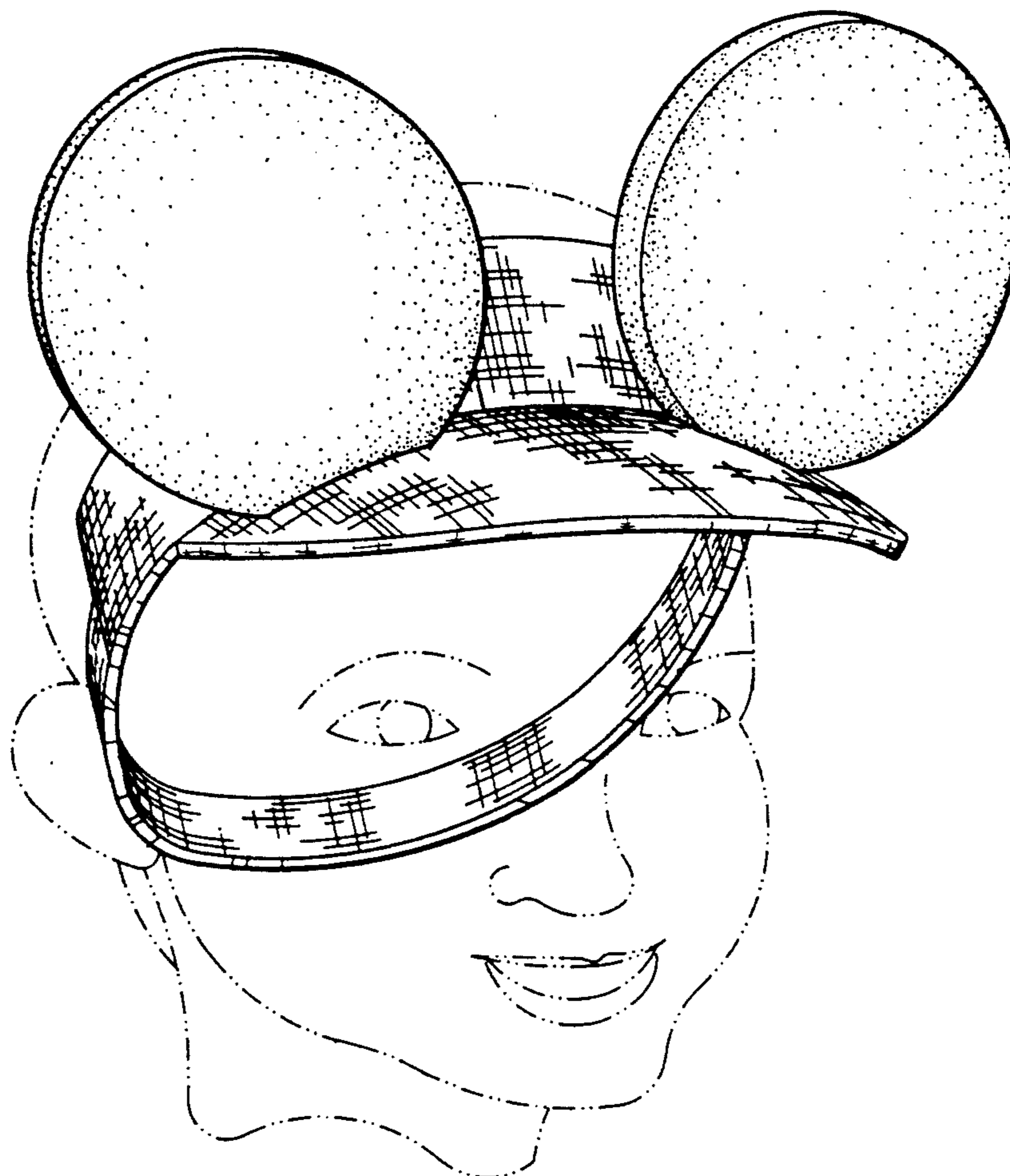

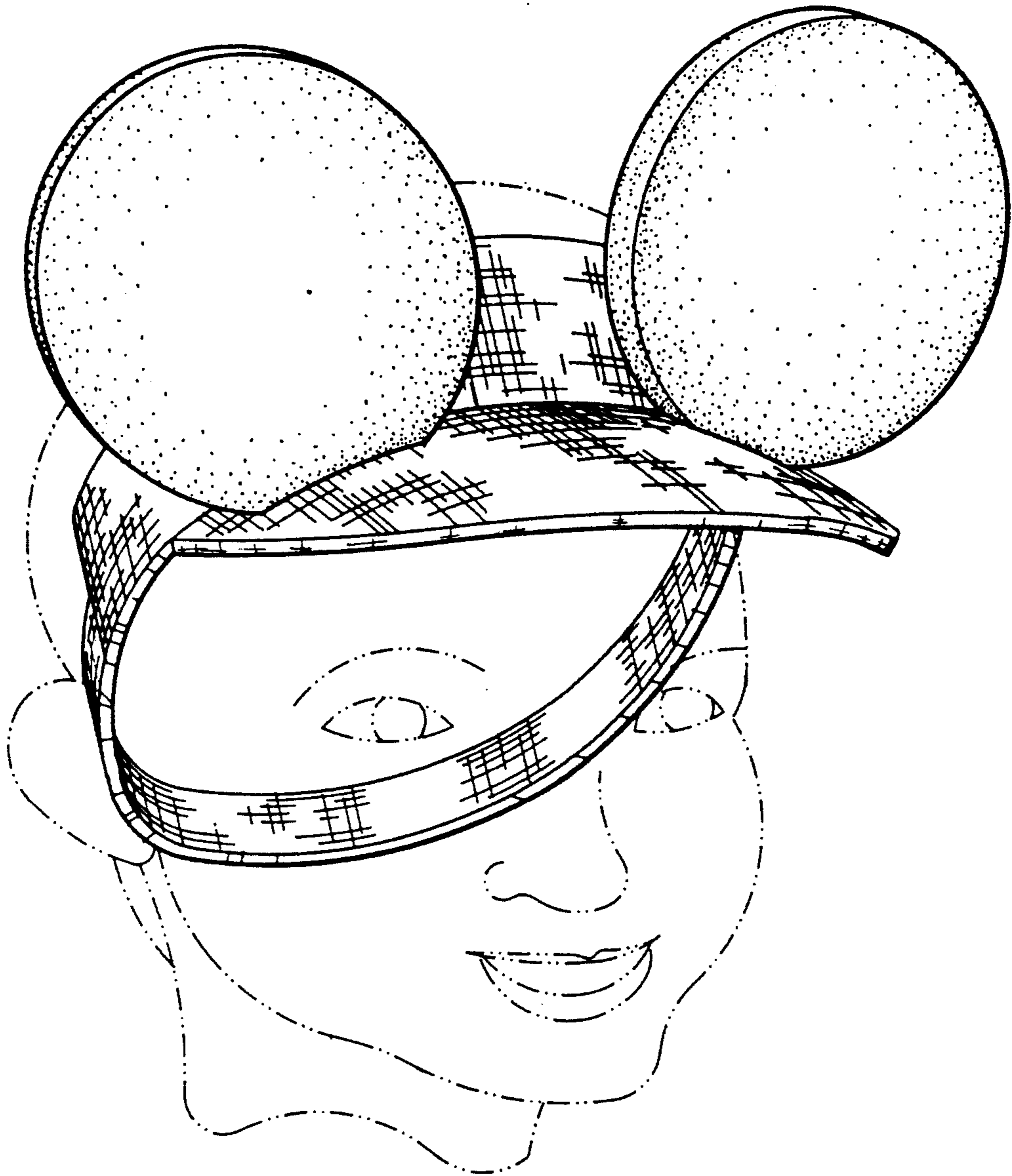

FIG. 1

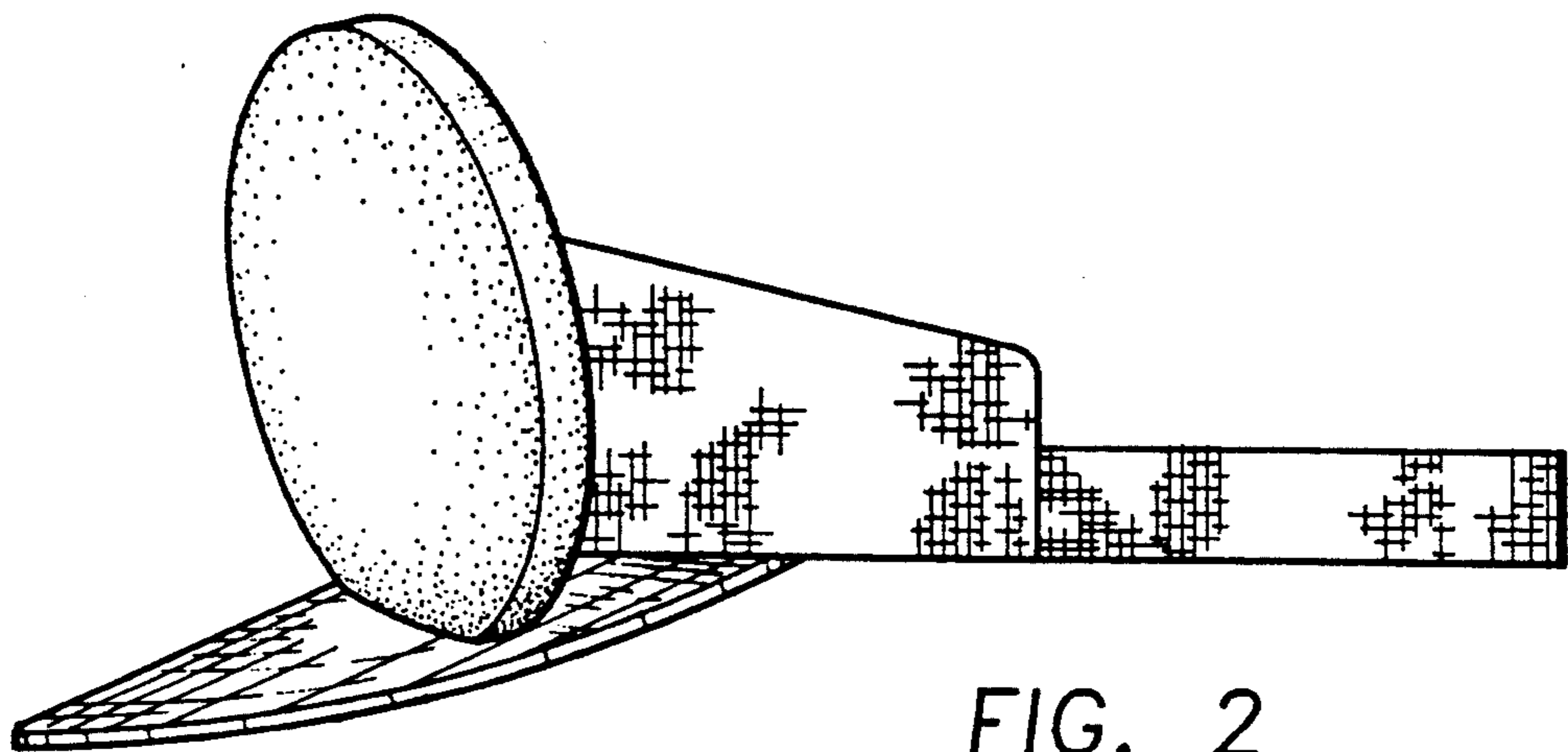

FIG. 2

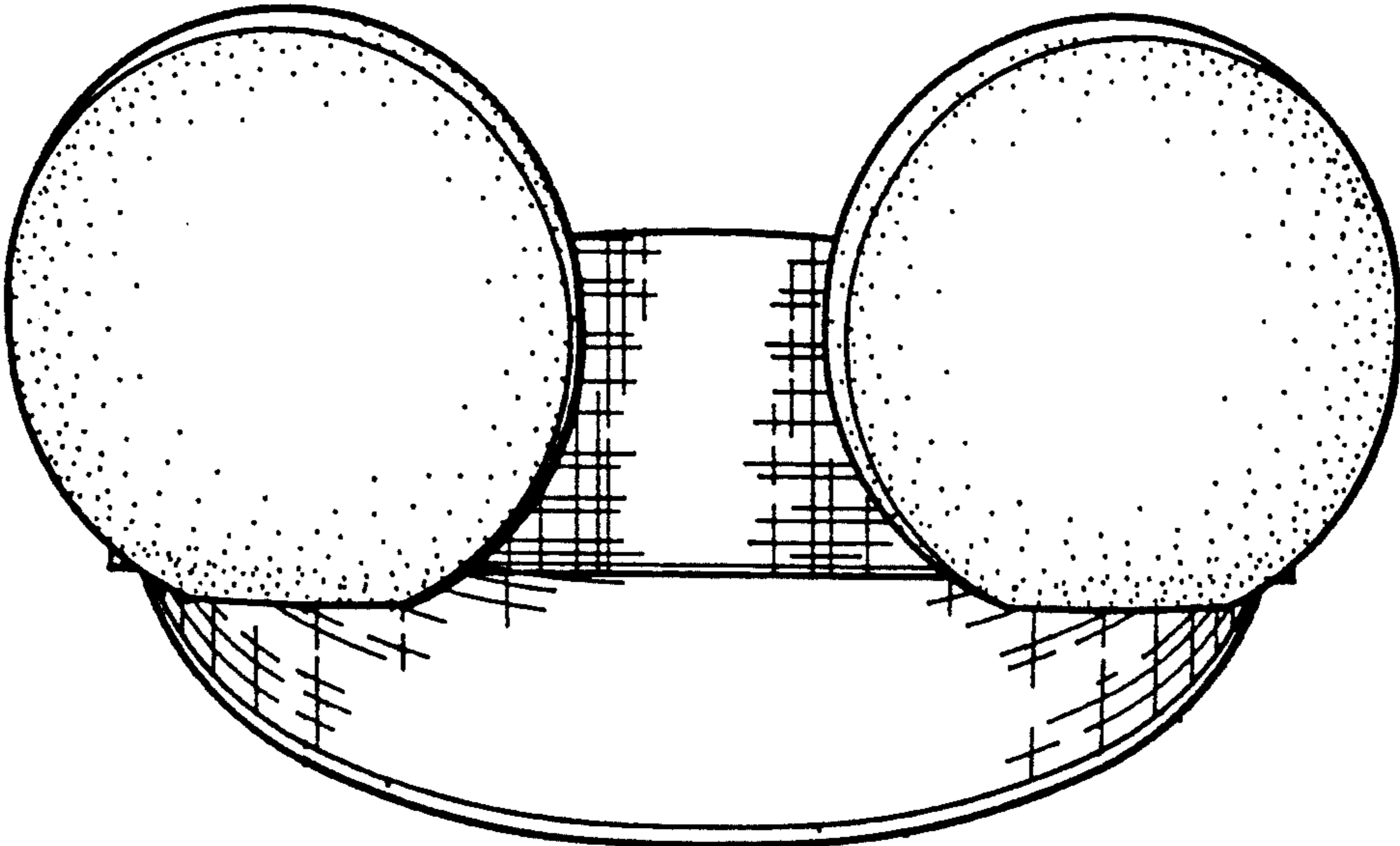

FIG. 3

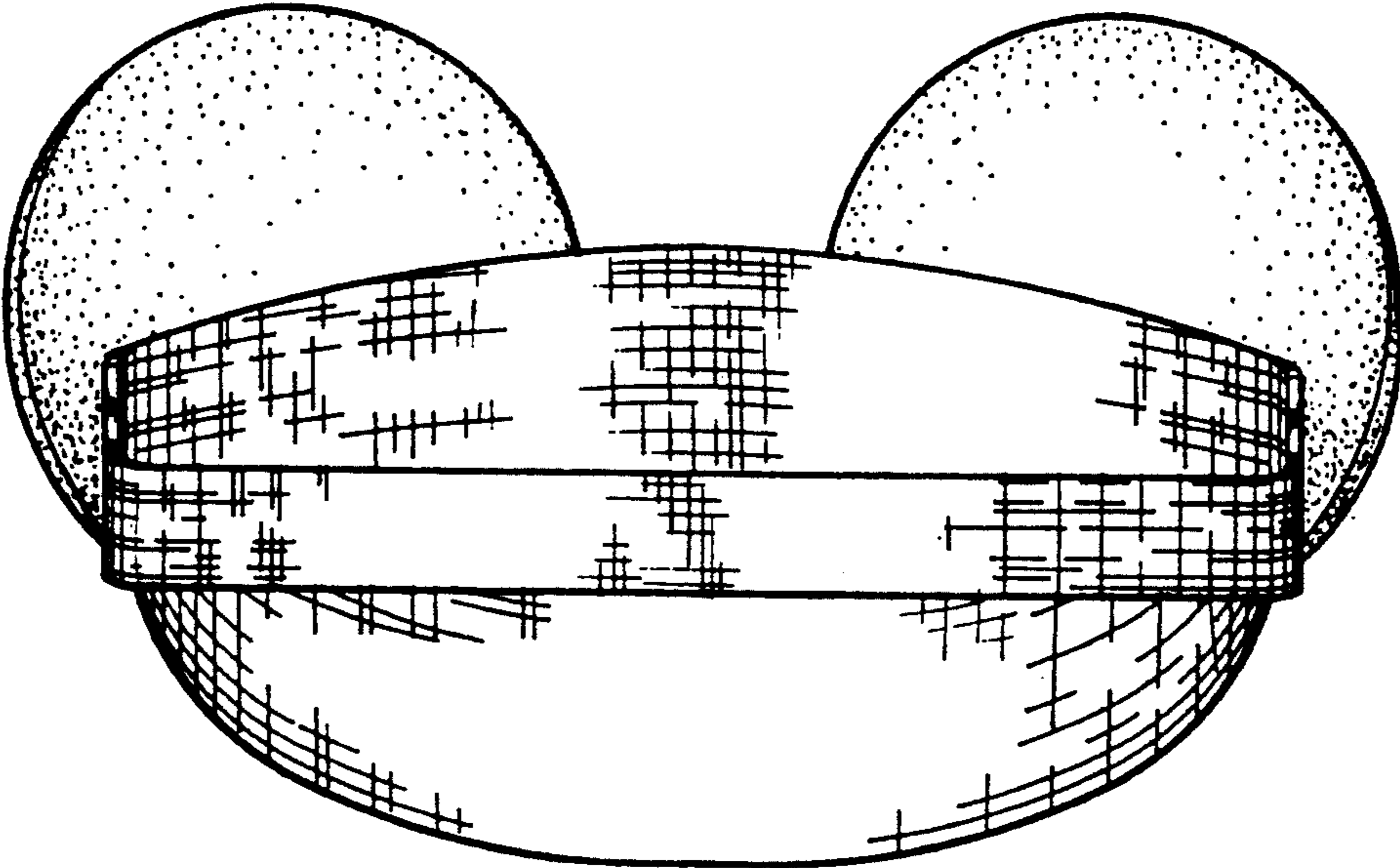

FIG. 4

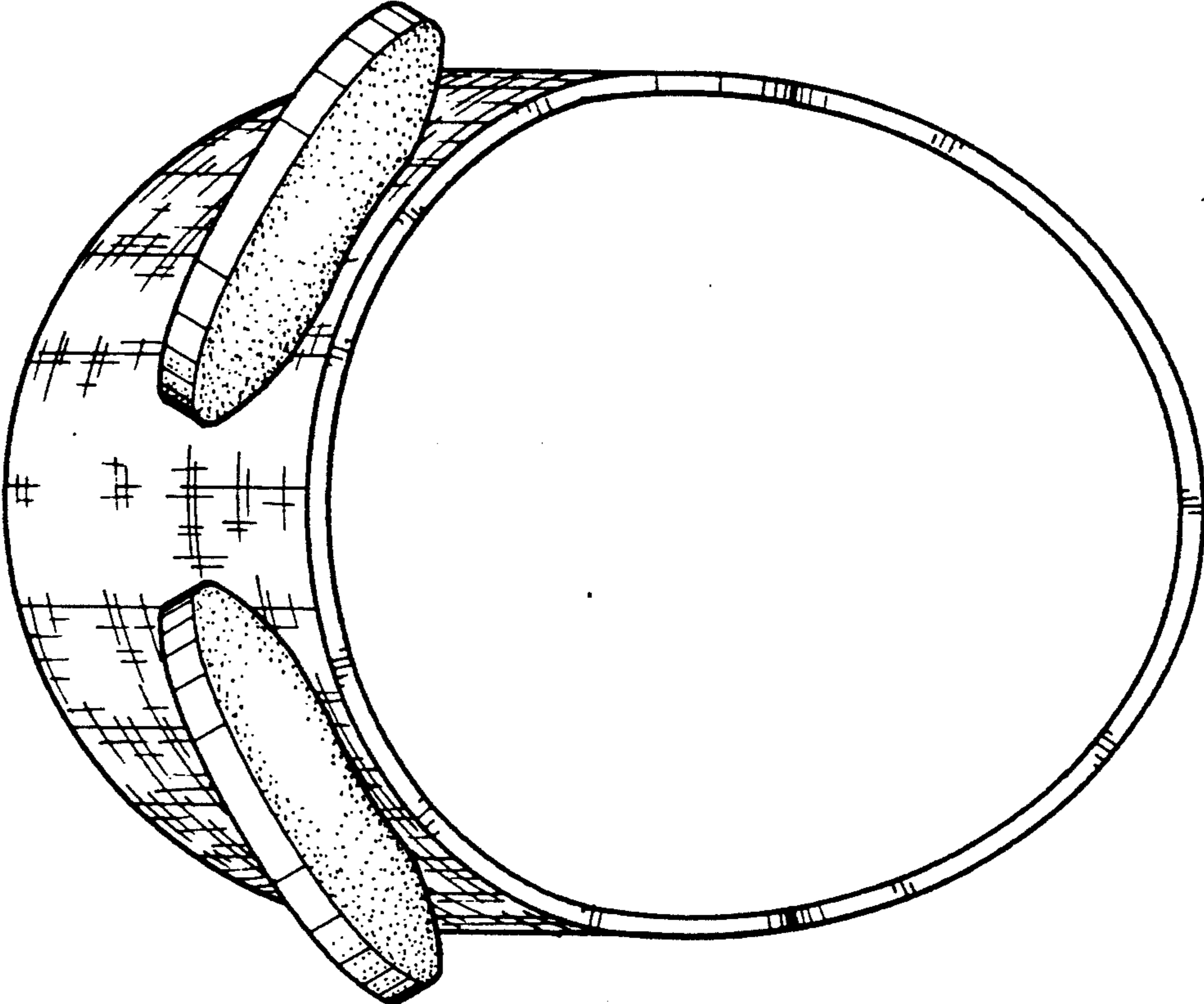

FIG. 5

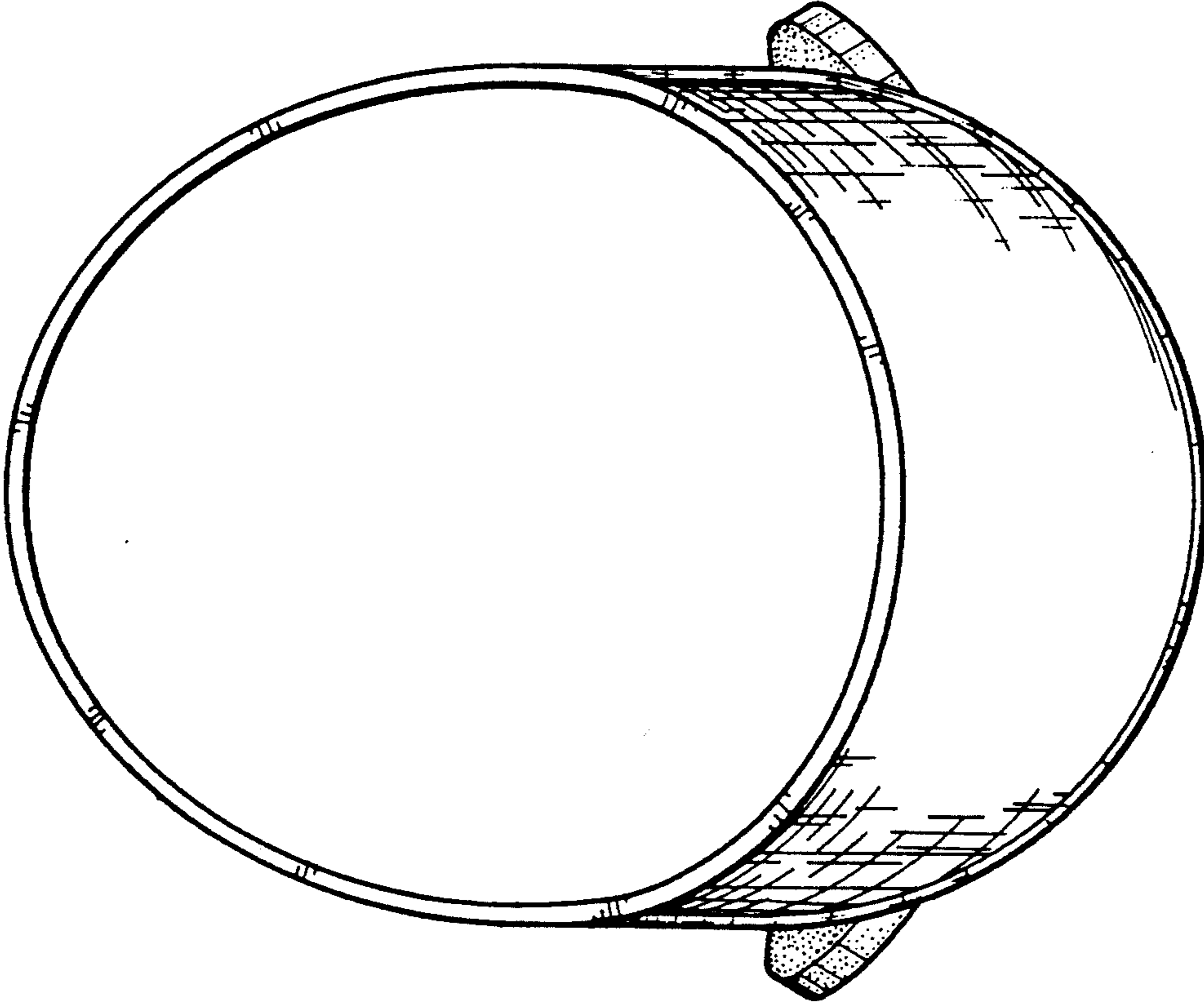

FIG. 6