



US00D348201S

# United States Patent [19]

[11] Patent Number: **Des. 348,201**

Ferrari

[45] Date of Patent: **\*\* Jun. 28, 1994**

[54] **FURNITURE HINGE CUP AND COVER-PLATE THEREFOR**

### FOREIGN PATENT DOCUMENTS

[76] Inventor: **Franco Ferrari, Frazione Deviscio, 1-22053 Lecco, Italy**

3431999 3/1986 Fed. Rep. of Germany ..... 16/374

[\*\*] Term: **14 Years**

*Primary Examiner*—B. J. Bullock

*Attorney, Agent, or Firm*—Shlesinger, Fitzsimmons & Shlesinger

[21] Appl. No.: **915,196**

### [57] CLAIM

[22] Filed: **Jul. 17, 1992**

The ornamental design for a furniture hinge cup and cover-plate therefor, as shown and described.

### [30] Foreign Application Priority Data

### DESCRIPTION

Jan. 27, 1992 [XB] Benelux ..... DM/021 804

[52] U.S. Cl. .... **D8/323**

[58] Field of Search ..... D8/323; 16/250, 251, 16/379, 386, 271

FIG. 1 is a top-plan view of the furniture hinge cup and cover-plate therefor;

FIG. 2 is a bottom plan view of the furniture hinge cup and cover-plate therefor;

FIG. 3 is a front end view of the furniture hinge cup and cover-plate therefor;

FIG. 4 is a rear end view of the furniture hinge cup and cover-plate therefor;

FIG. 5 is a left side view of the furniture hinge cup and cover-plate therefor;

FIG. 6 is a right side view of the furniture hinge cup and cover-plate therefor; and,

FIG. 7 is perspective view of the furniture hinge cup and cover-plate therefor.

### [56] References Cited

#### U.S. PATENT DOCUMENTS

D. 268,893	5/1983	Salice .....	D8/323
D. 272,211	1/1984	Rock et al. ....	D8/323
D. 299,616	1/1989	Ferrari .....	D8/323
D. 309,704	8/1990	Grass .....	D8/323
1,058,740	4/1913	Fisher .....	16/379
4,176,424	12/1979	Röck et al. ....	16/250
4,270,240	6/1981	Zernig et al. ....	16/250
4,368,559	1/1983	Oepping et al. ....	16/386

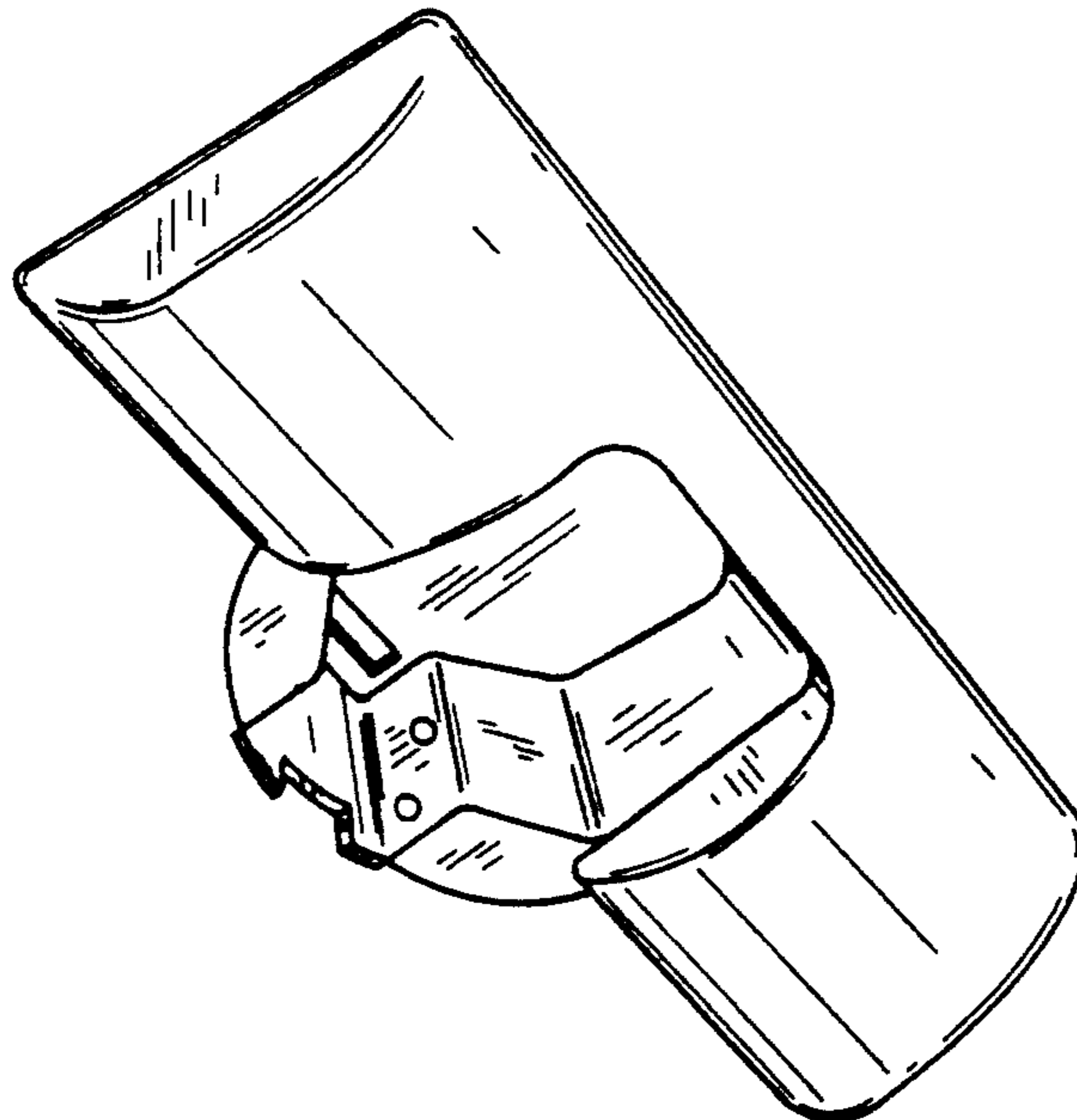

FIG. 1

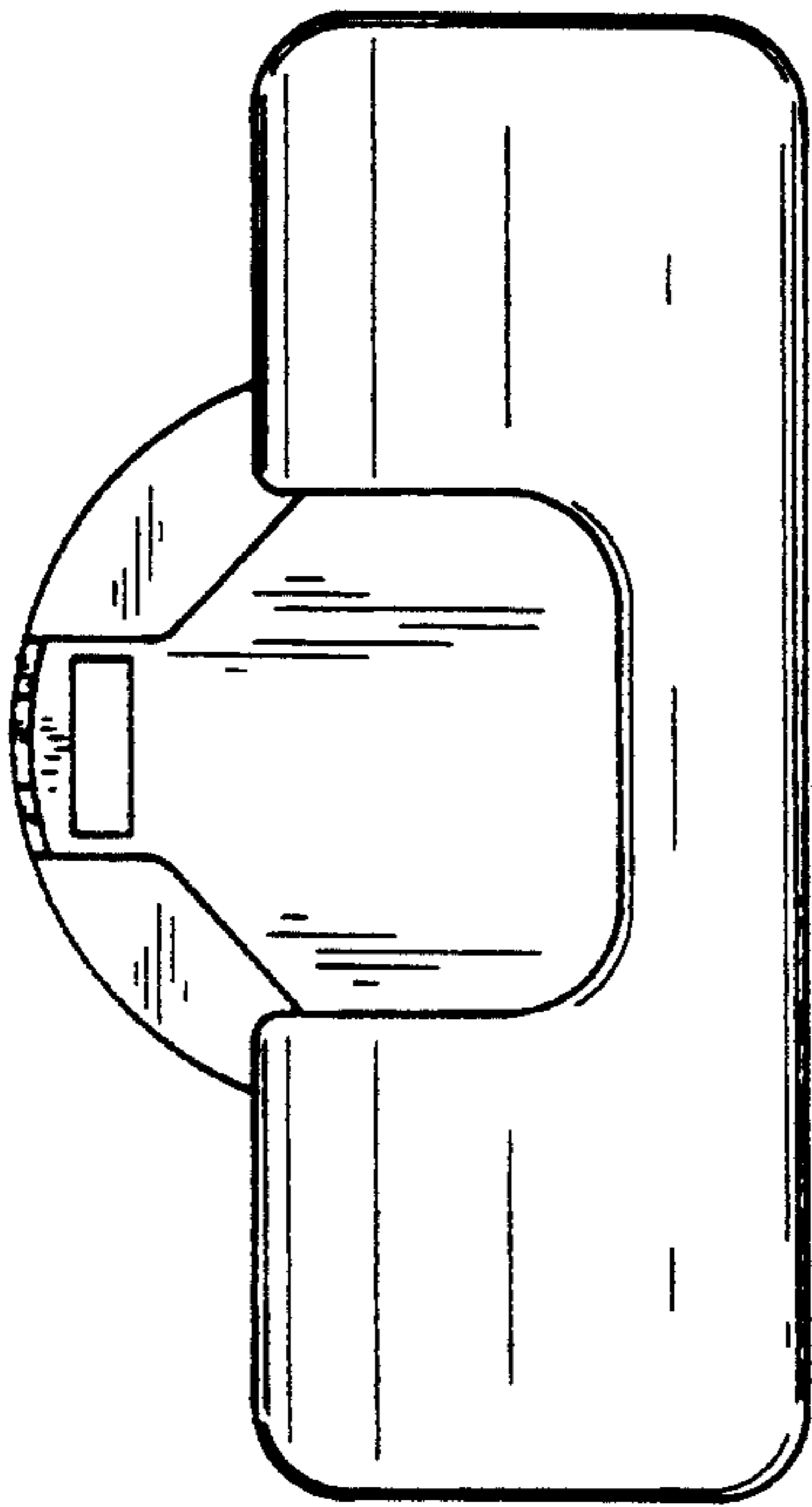

FIG. 2

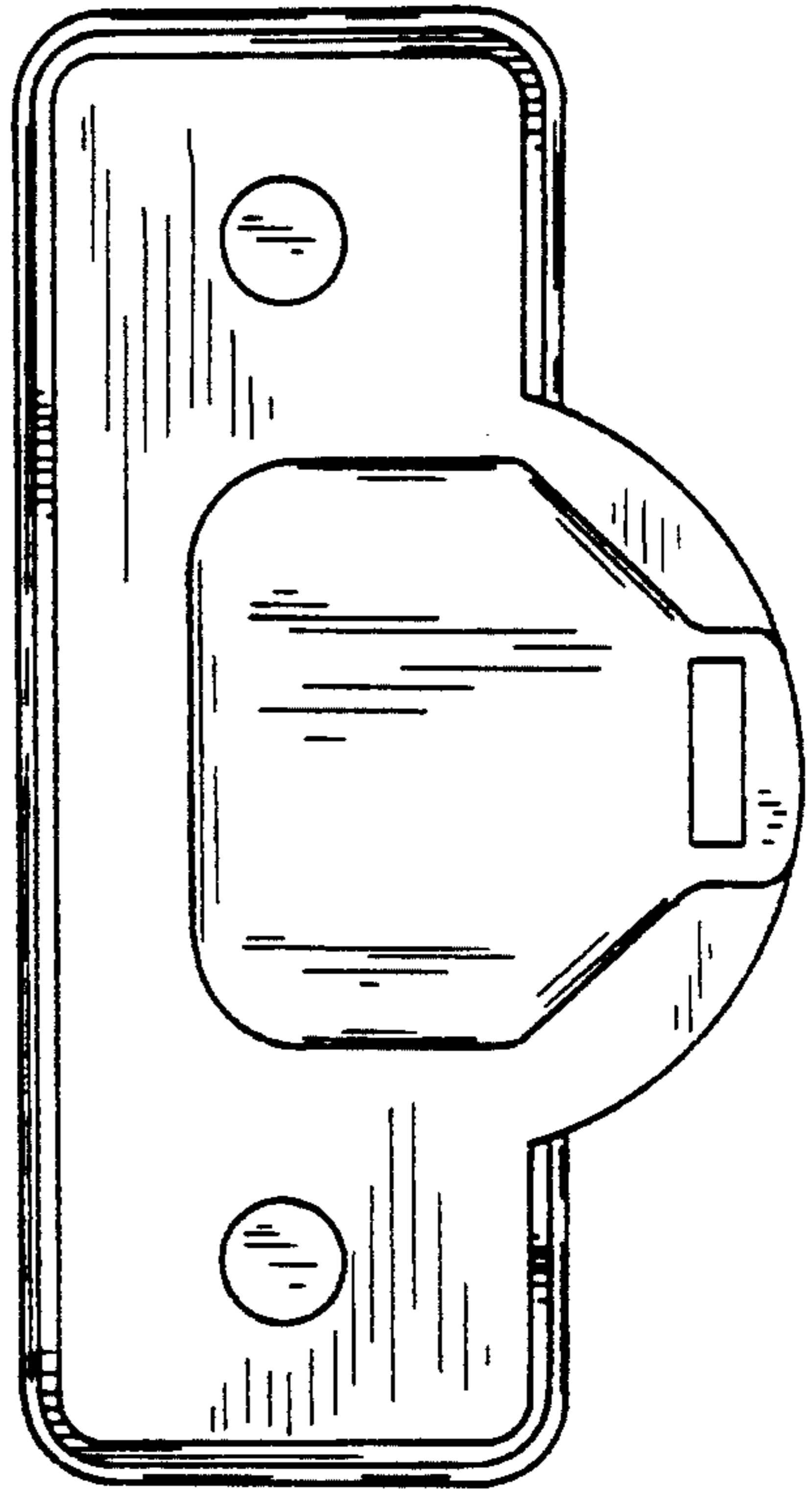

FIG. 3

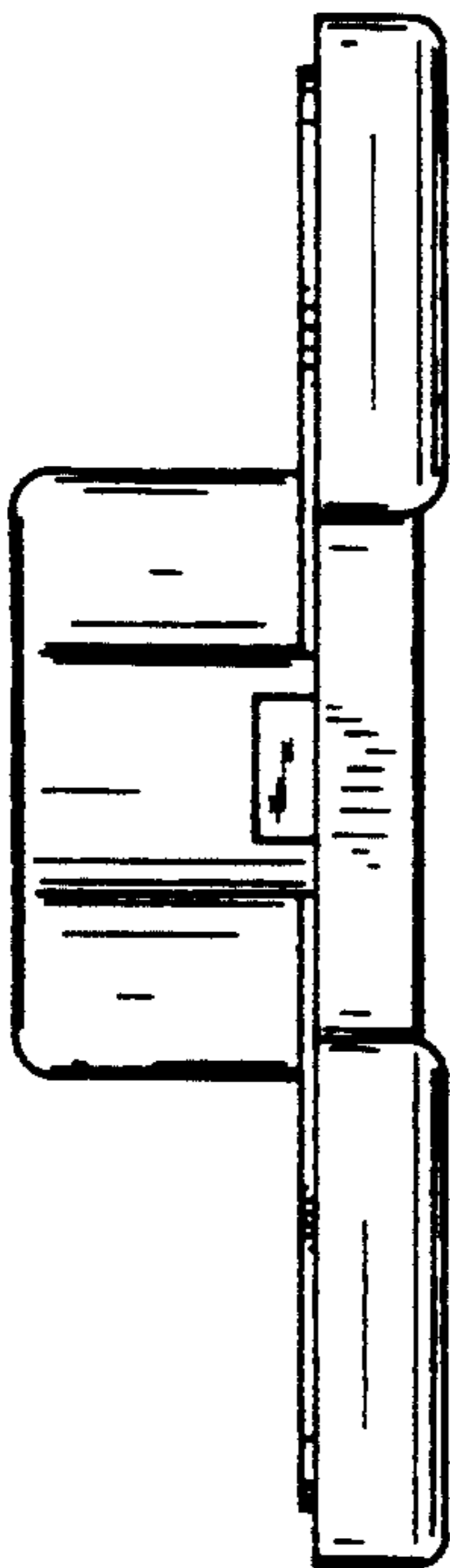

FIG. 4

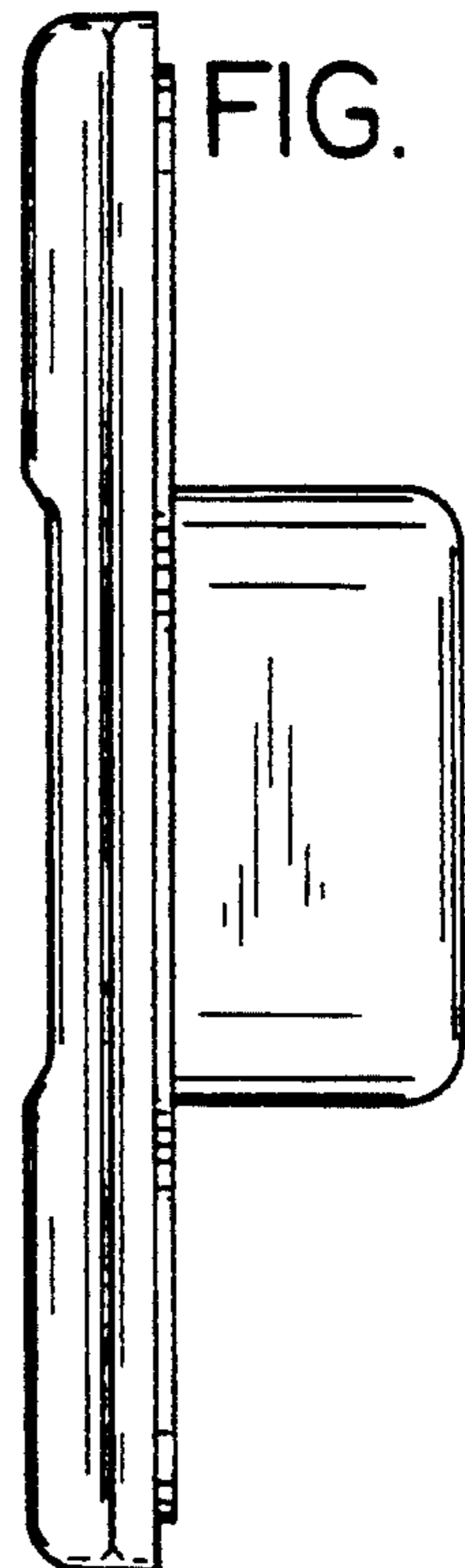

FIG. 5

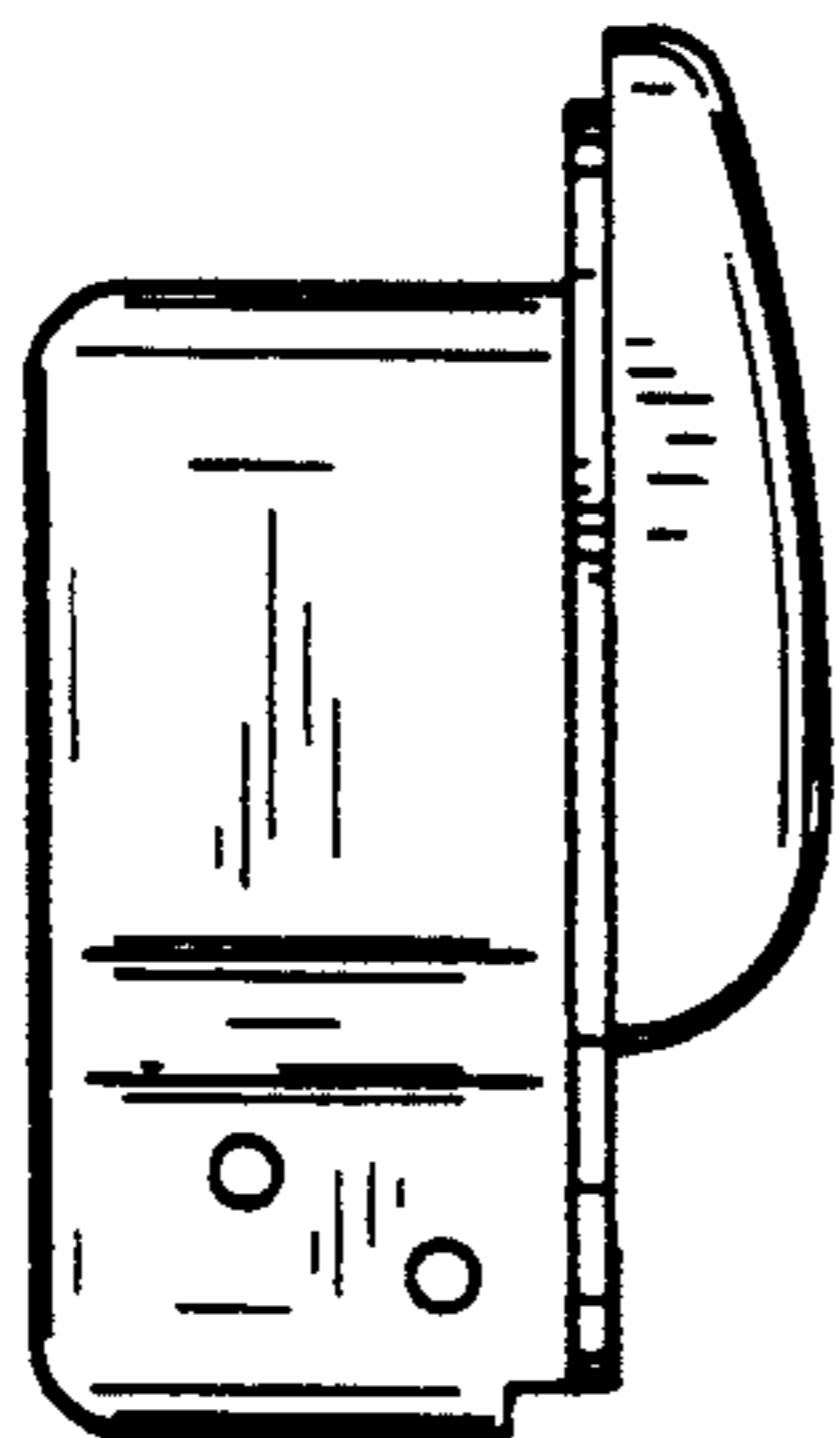

FIG. 6

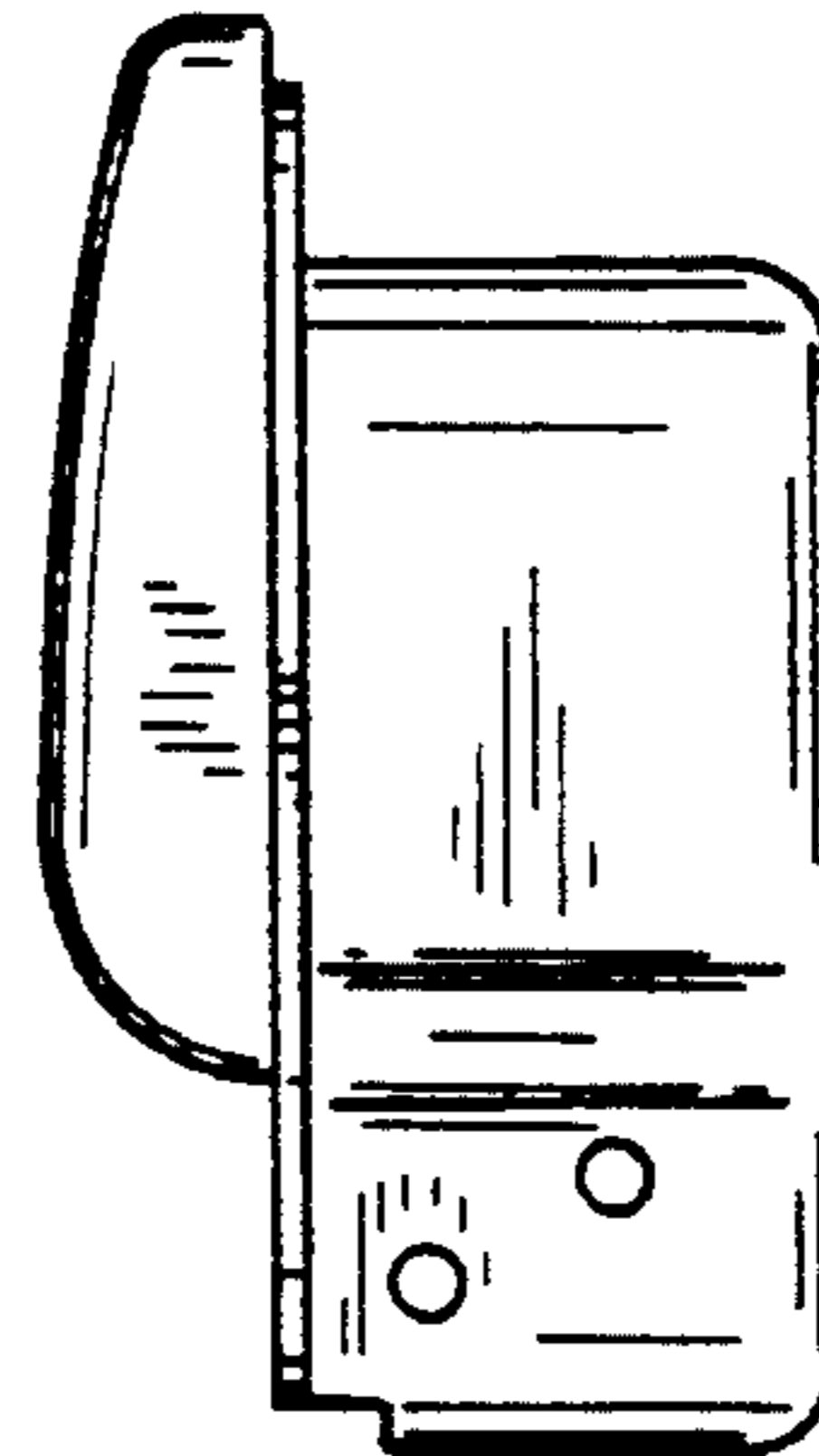

FIG. 7

