



US00D348142S

# United States Patent [19] Brooker

[11] Patent Number: **Des. 348,142**  
[45] Date of Patent: **\*\* Jun. 28, 1994**

[54] **ELEMENT OF UPPER BODY CLOTHING**  
[76] Inventor: **Mark C. Brooker**, 6656 S. Hartwell,  
Chicago, Ill. 60637  
[\*\*] Term: **14 Years**  
[21] Appl. No.: **842,591**  
[22] Filed: **Mar. 25, 1992**  
[52] U.S. Cl. .... **D2/610**  
[58] Field of Search ..... **D2/610, 625, 611, 225,**  
**D2/267, 60, 62, 84, 169, 178, 107; 2/59, 22, 60,**  
**61, 2, 16, 24, 126, 170, DIG. 6; 602/62, 63, 64,**  
**65, 26, 27; D8/72; D29/20**

4,832,010 5/1989 Lerman ..... 2/2 X  
4,843,645 7/1989 White ..... 2/59  
4,951,317 8/1990 Gray et al. .... 2/59 X  
4,985,934 1/1991 Perry ..... 2/59 X

*Primary Examiner*—Melvin B. Feifer  
*Assistant Examiner*—Paula Mortimer  
*Attorney, Agent, or Firm*—Michael R. McKenna

### [57] CLAIM

The ornamental design for an element of upper body clothing, as shown and described.

### DESCRIPTION

FIG. 1 is a front perspective view of an element of upper body clothing showing my new design; FIG. 2 is a top perspective view thereof; FIG. 3 is a front elevational view thereof; FIG. 4 is a right side perspective view thereof; FIG. 5 is a rear elevational view thereof; and, FIG. 6 is a fragmentary view thereof. The broken line showing of the sleeve and the shirt in all views is for illustrative purposes only and forms no part of the claimed design.

[56] **References Cited**  
**U.S. PATENT DOCUMENTS**  
D. 239,788 5/1976 Allaway ..... D2/610  
D. 313,674 1/1991 Sharpe ..... D2/610 X  
410,600 9/1889 Mills ..... 2/59 X  
1,577,630 3/1926 Yerger ..... 2/59  
3,329,143 7/1967 Gordon ..... 2/59 X  
3,657,741 4/1972 Blanco ..... 2/59

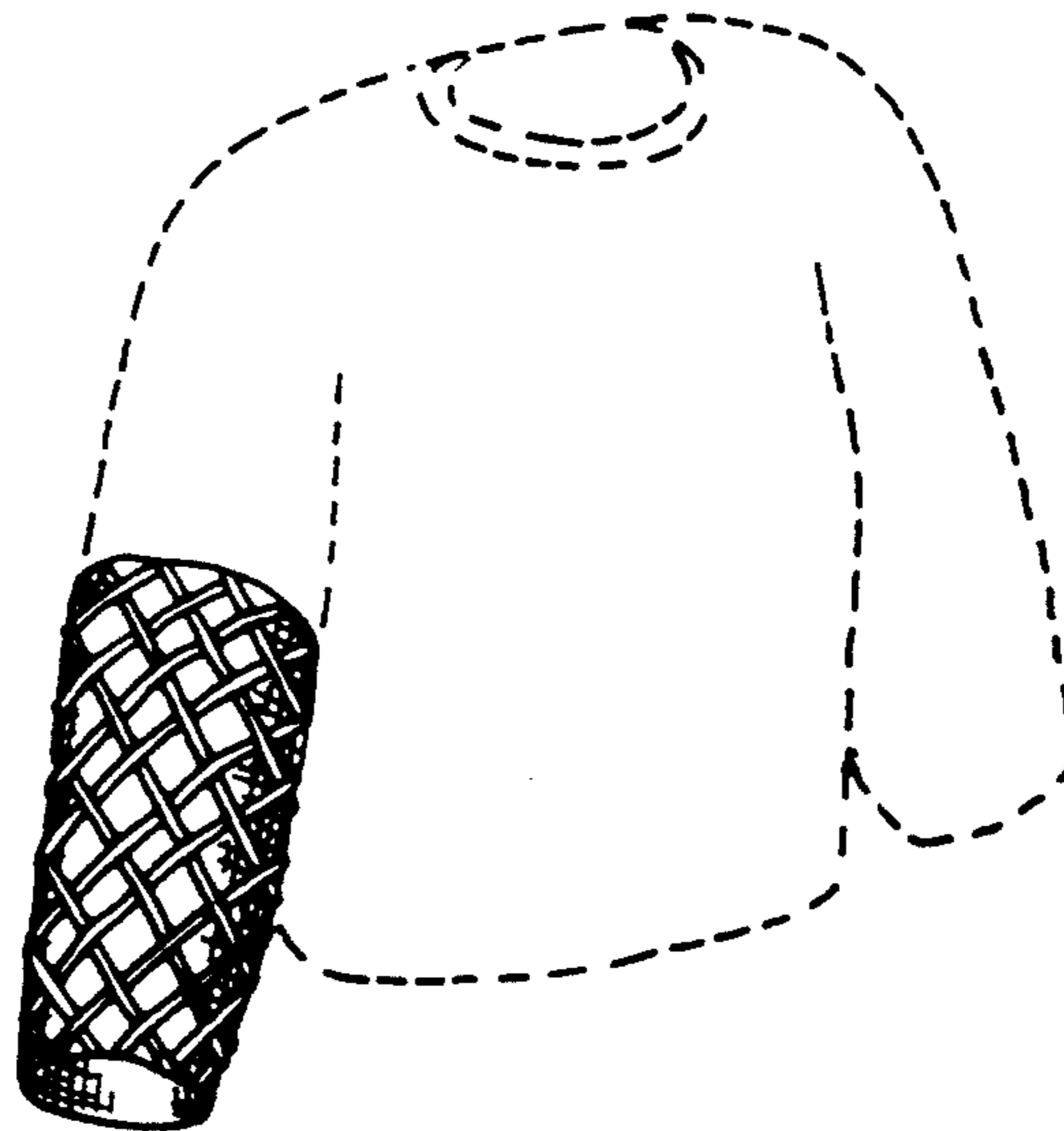

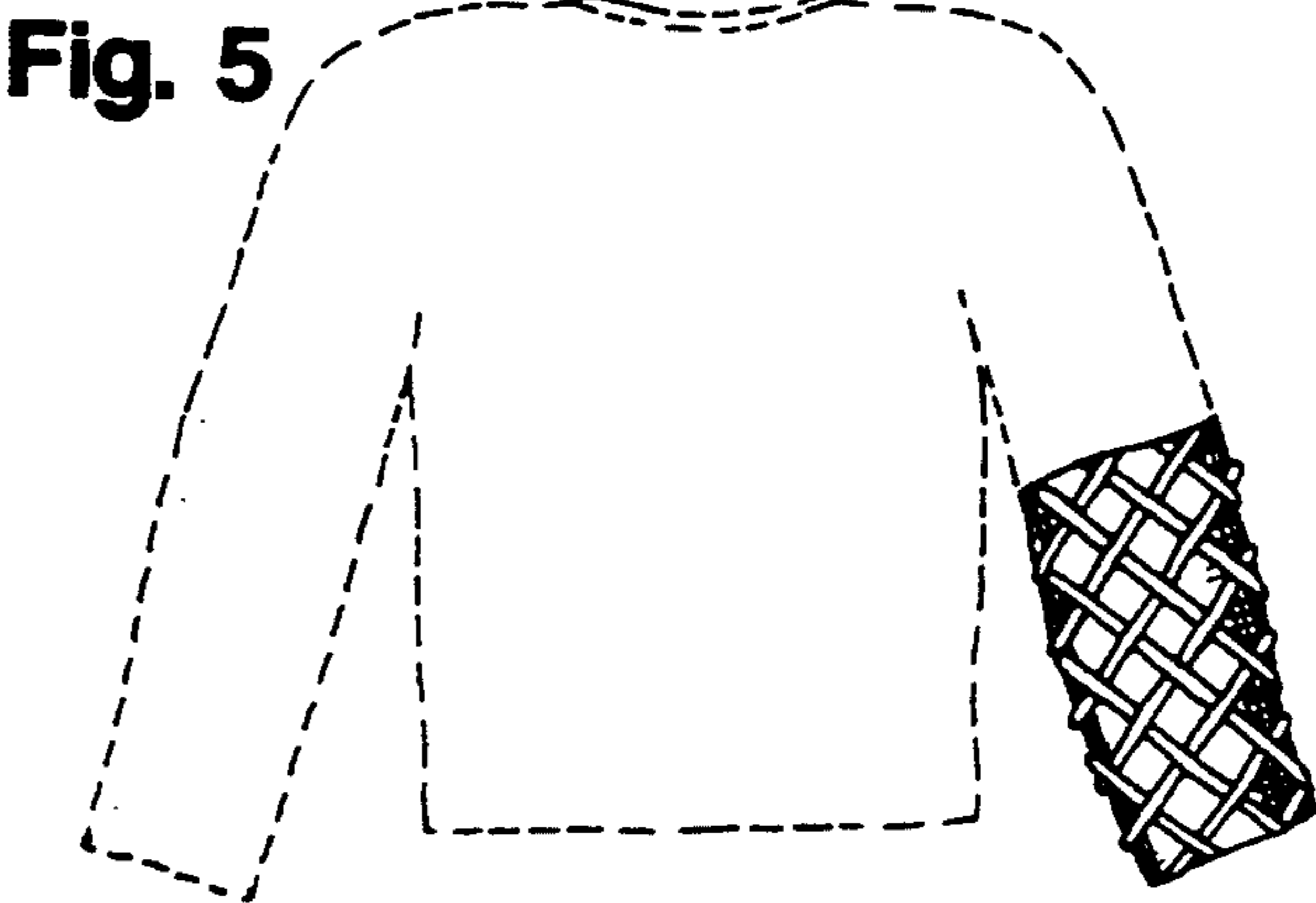
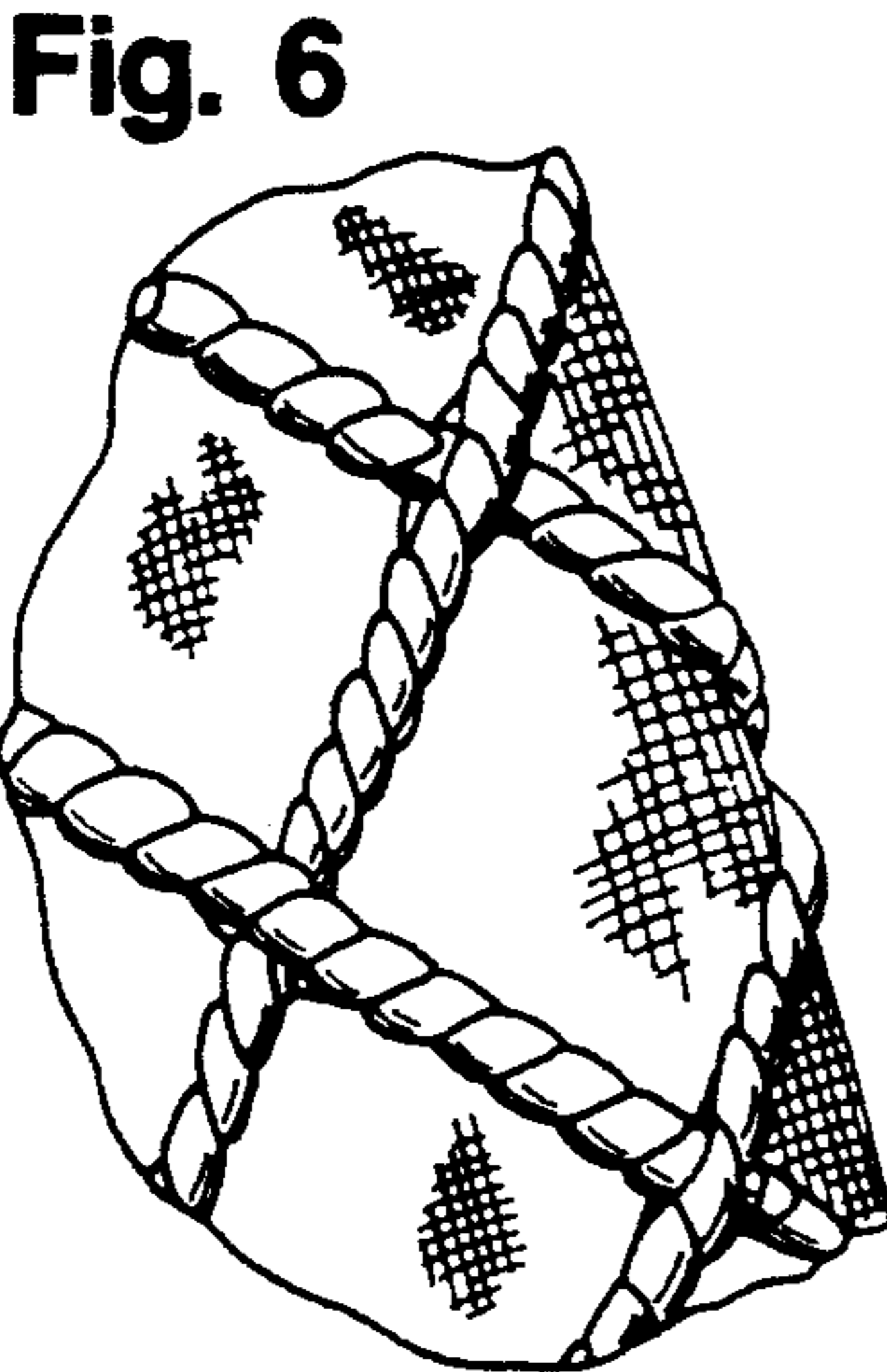
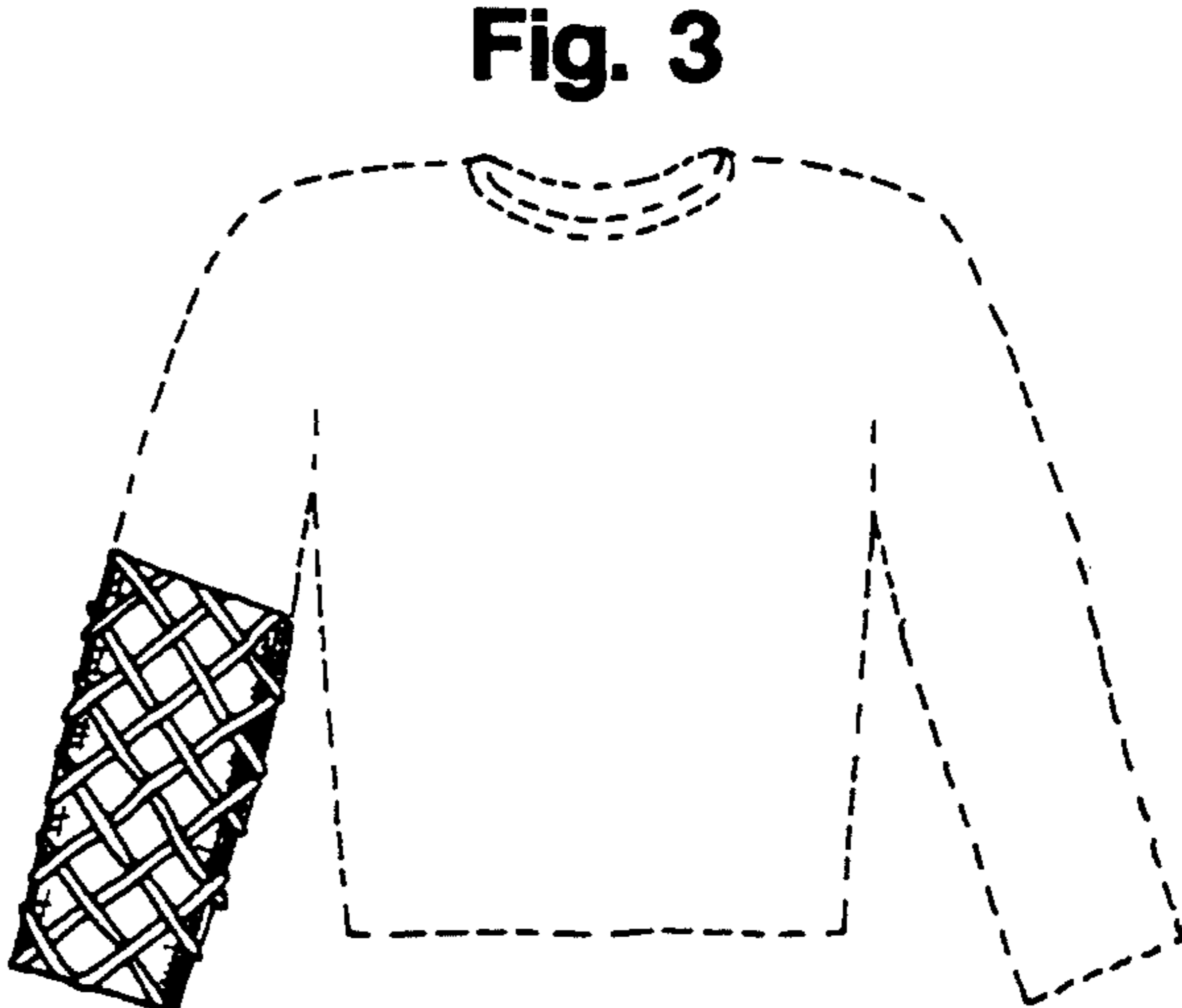
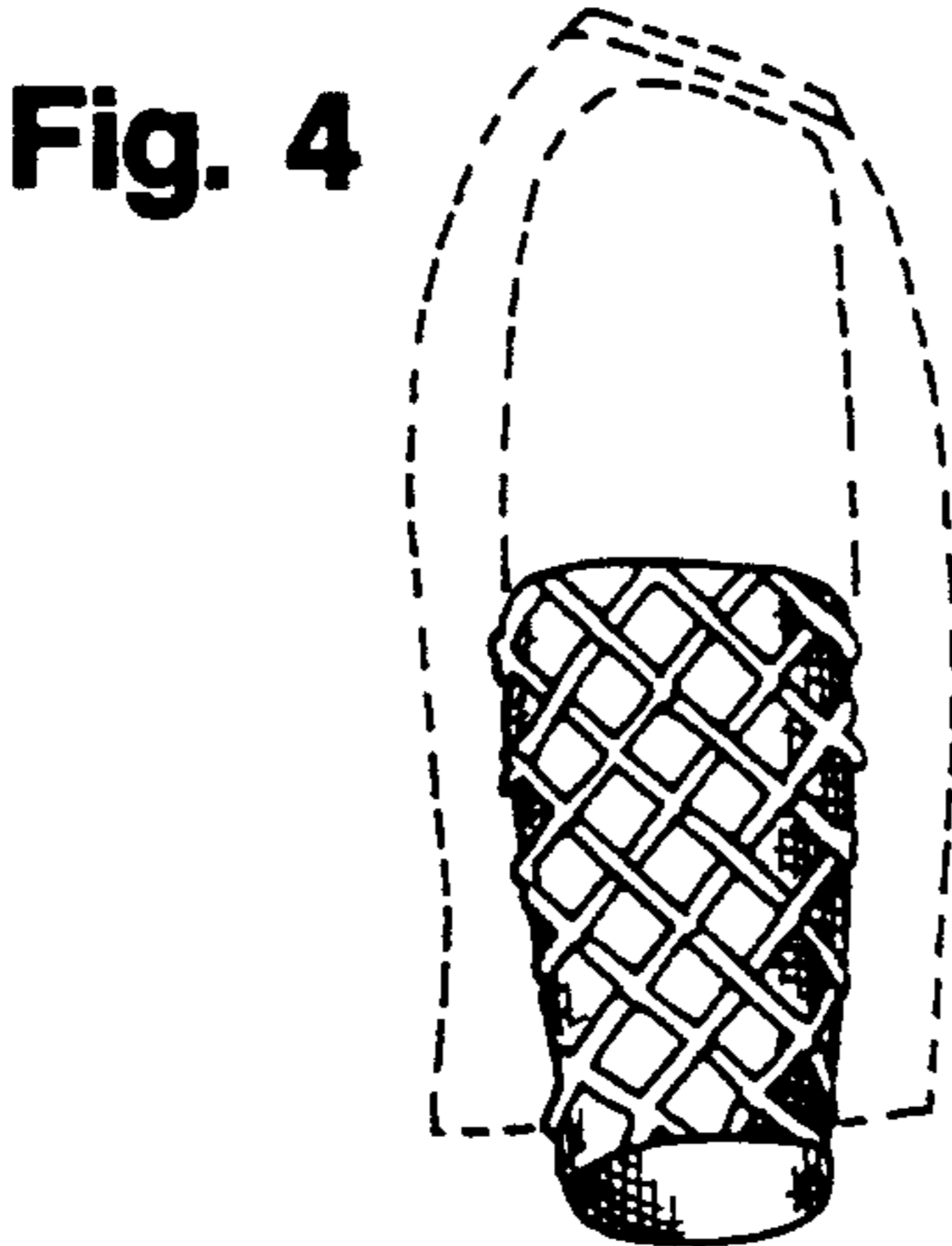
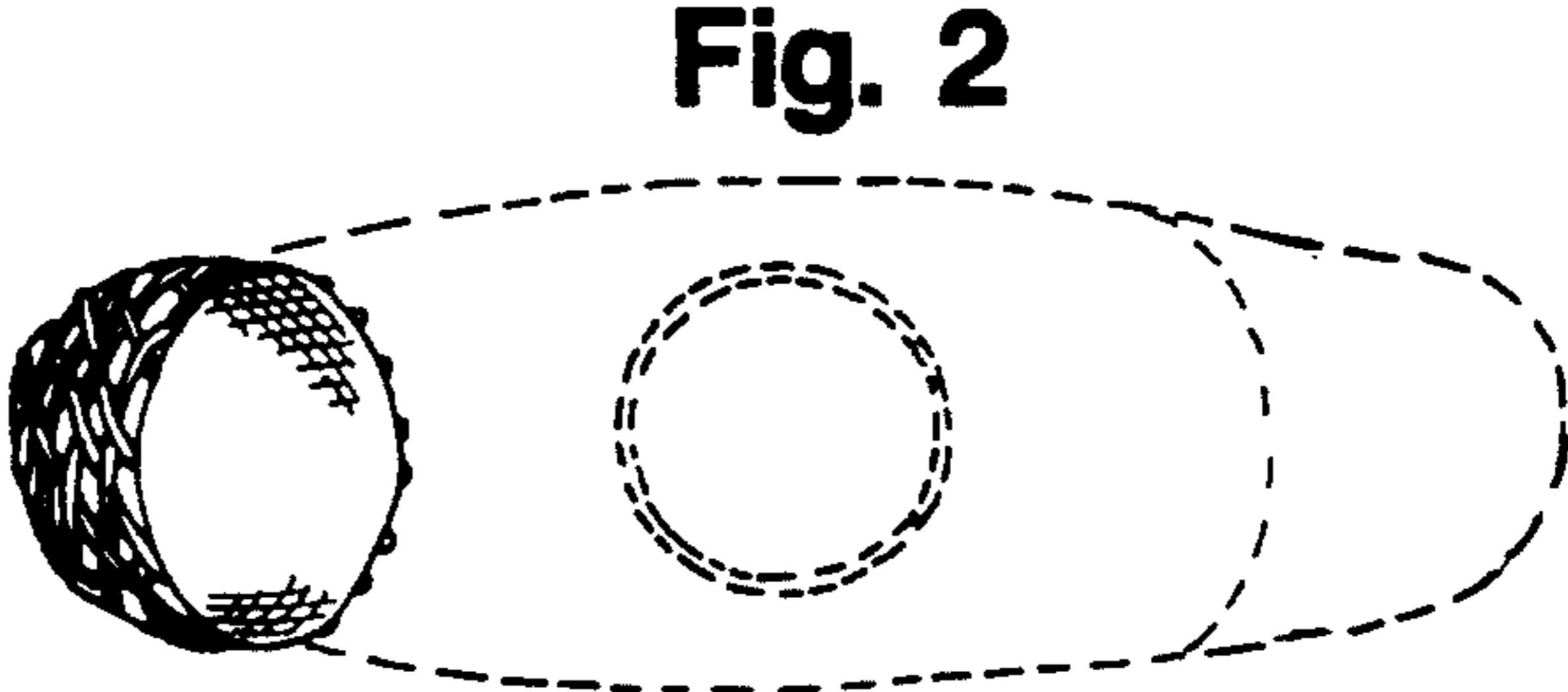
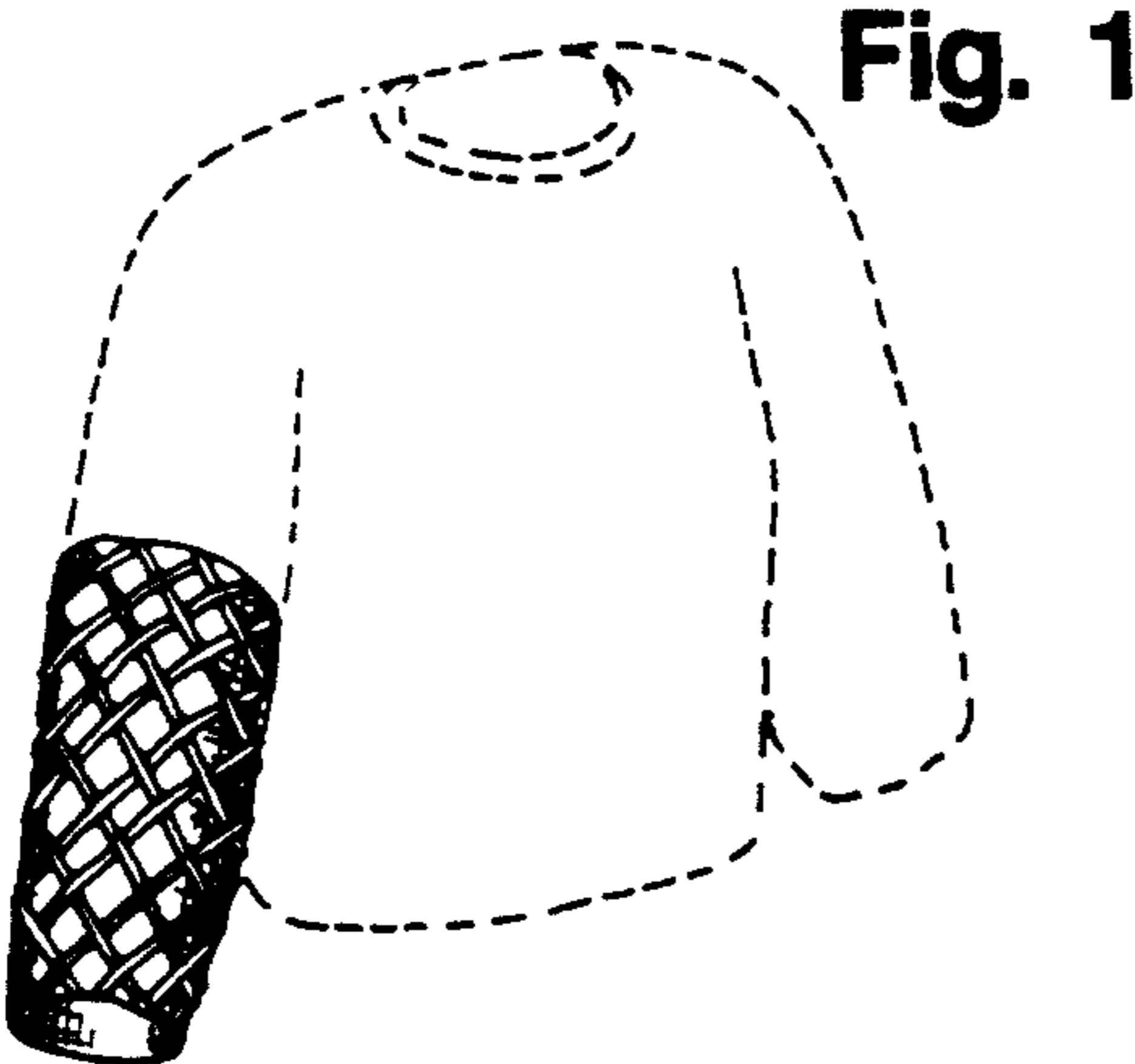

UNITED STATES PATENT AND TRADEMARK OFFICE  
**CERTIFICATE OF CORRECTION**

**PATENT NO.** : Des.348,142

**DATED** : June 28, 1994

**INVENTOR(S)** : Mark C. Booker

It is certified that error appears in the above-identified patent and that said Letters Patent is hereby corrected as shown below:

On the title page: Item

[76] Inventor: Mark C. Booker,  
6656 S. Hartwell  
Chicago, Ill. 60637

Signed and Sealed this

Twenty-seventh Day of September, 1994

Attest:



BRUCE LEHMAN

Attesting Officer

Commissioner of Patents and Trademarks