



US00D348141S

United States Patent [19]

[11] Patent Number: **Des. 348,141**

Lars-Jos, Jr. et al.

[45] Date of Patent: **** Jun. 28, 1994**

[54] **BUTCHER'S GLOVE WITH LOWER ARM PROTECTION**

[75] Inventors: **Pehr Lars-Jos, Jr., Malung; Mikael Ståhl, Karlskoga, both of Sweden**

[73] Assignee: **Ergoflex AB, Karlskoga, Sweden**

[**] Term: **14 Years**

[21] Appl. No.: **788,263**

[22] Filed: **Nov. 4, 1991**

[30] **Foreign Application Priority Data**

May 2, 1991 [SE] Sweden 968/91

[52] U.S. Cl. **D2/610; D29/20**

[58] Field of Search **D2/610, 621, 618, 619; 2/48, 159, 169, 160, 161 R, 161 A, 167.2; D29/20**

[56] **References Cited**

U.S. PATENT DOCUMENTS

1,934,332	11/1933	Skinner	D2/621 X
2,106,348	1/1938	Hall et al.	D2/621 X
4,172,293	10/1979	Vistins	2/48 X
4,445,232	5/1984	Nelson	2/167 X
4,802,242	2/1939	Lars-Jos	2/2
4,825,499	5/1989	Baptiste	2/167 X

Primary Examiner—Bernard Ansher
Assistant Examiner—Paula Mortimer
Attorney, Agent, or Firm—Pollock, Vande Sande & Priddy

[57] **CLAIM**

The ornamental design for a butcher's glove with lower arm protection, as shown and described.

DESCRIPTION

FIG. 1 is a front elevational view of a butcher's glove with lower arm protection showing our new design, the pattern is understood to continue throughout the glove;

FIG. 2 is a rear view thereof;
 FIG. 3 is a side view thereof;
 FIG. 4 is a perspective view thereof with a person's hand inserted into the glove;
 FIG. 5 is a fragmentary view of the upper hand portion of the glove;
 FIG. 6 is a fragmentary view of the lower arm portion of the glove;
 FIG. 7 is a fragmentary view of the hand and wrist junction portion of the glove;
 FIG. 8 is a rear view of a second embodiment of a butcher's glove showing our new design;
 FIG. 9 is a front view thereof;
 FIG. 10 is a side view thereof;
 FIG. 11 is a rear view of a third embodiment of the butcher's glove showing my new design;
 FIG. 12 is a front view thereof;
 FIG. 13 is a side view thereof;
 FIG. 14 is a top view thereof;
 FIG. 15 is a bottom view thereof;
 FIG. 16 is a rear view of a fourth embodiment of the butcher's glove showing our new design;
 FIG. 17 is a front view thereof;
 FIG. 18 is a side thereof;
 FIG. 19 is a top view of thereof;
 FIG. 20 is a bottom view thereof;
 FIG. 21 is a rear view of a fourth embodiment of the butcher's glove showing our new design;
 FIG. 22 is a front view thereof;
 FIG. 23 is a side thereof;
 FIG. 24 is a top view of thereof;
 FIG. 25 is a bottom view thereof;
 FIG. 26 is a top view of the embodiment shown in FIG. 4;
 FIG. 27 is a bottom view thereof;
 FIG. 28 is a top view of the embodiment shown in FIG. 8; and,
 FIG. 29 is a bottom view of thereof.
 The broken line showing the word ERGOFLEX is for illustrative purposes only and forms no part of the claimed design.

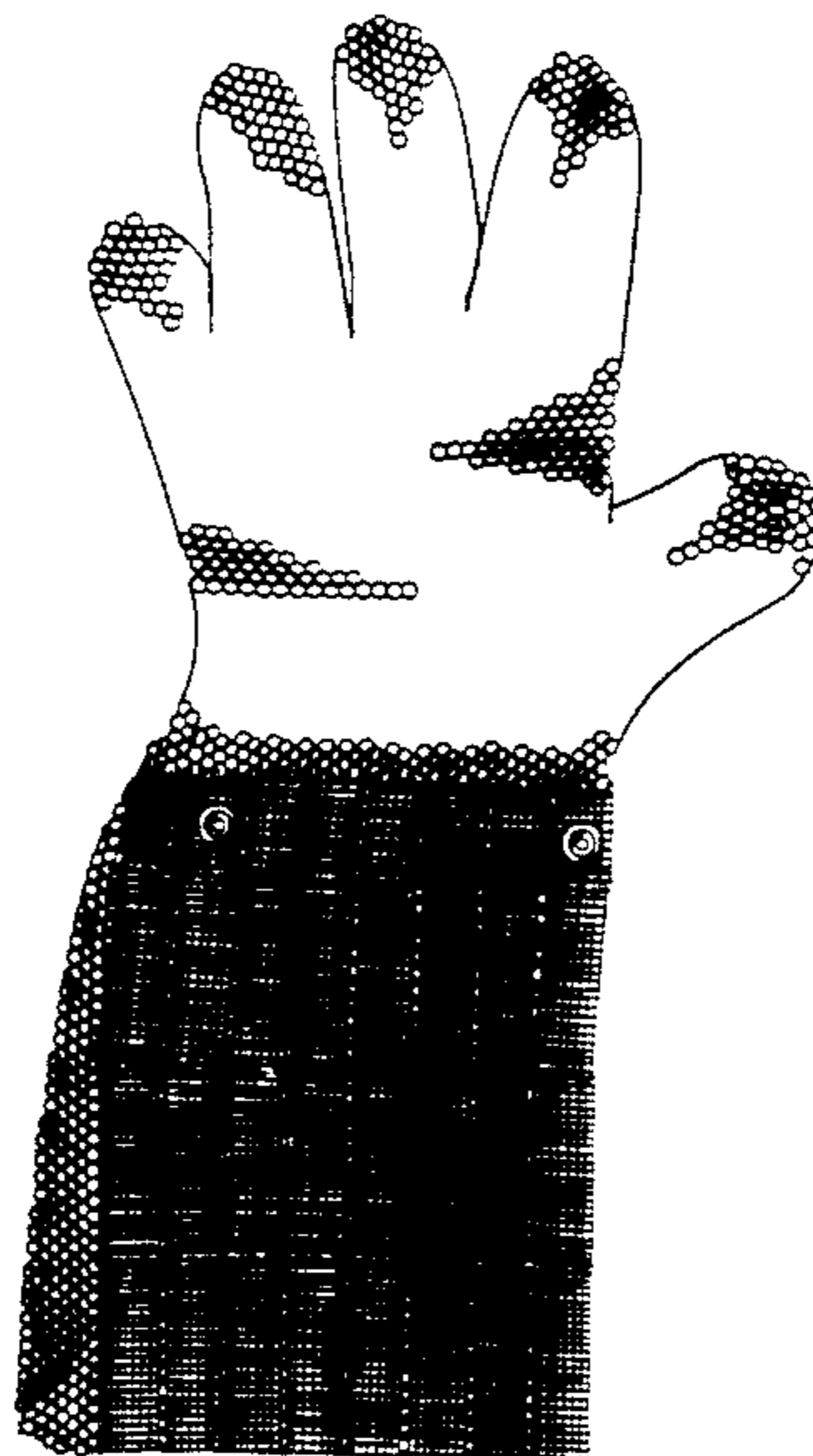

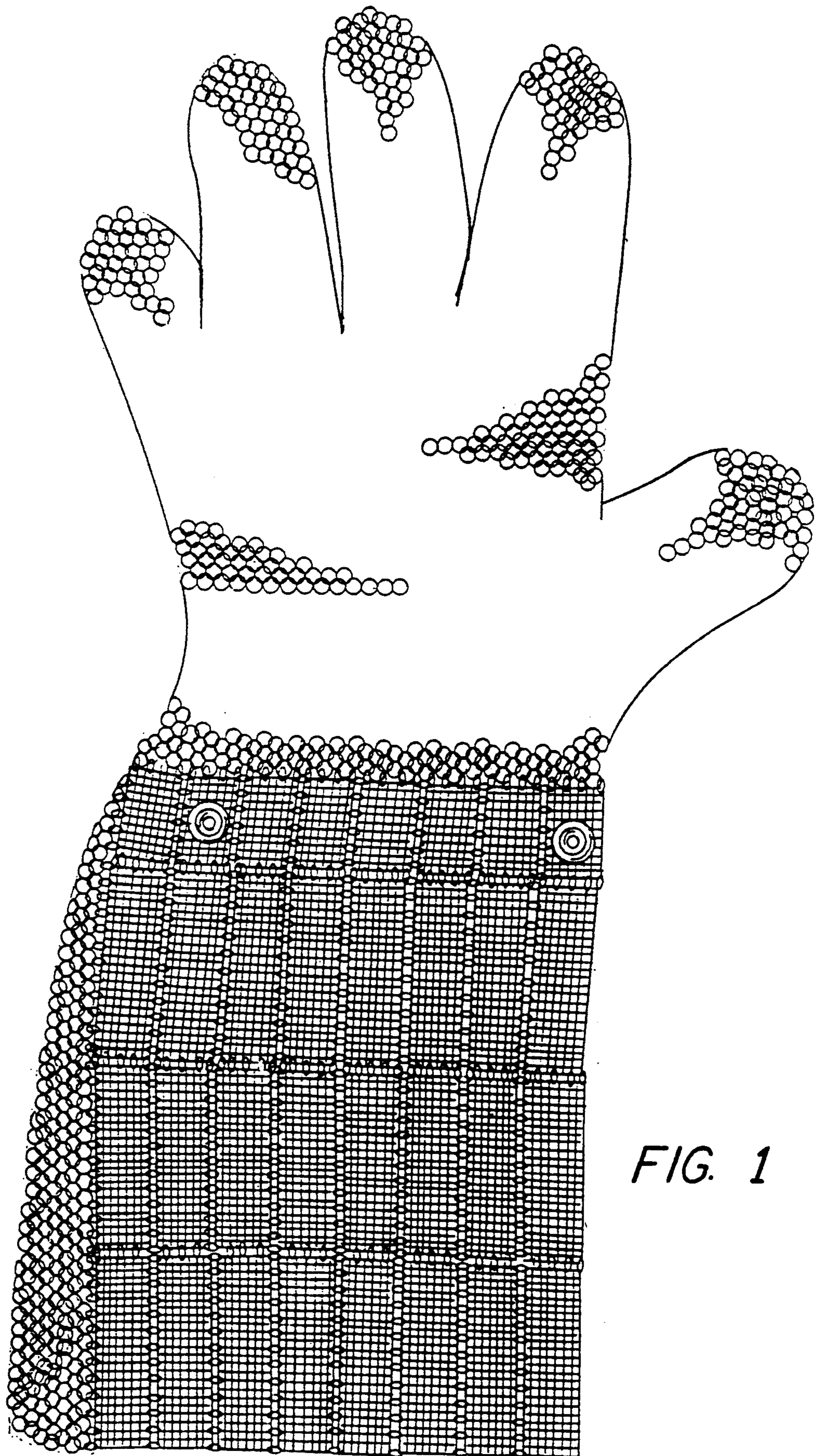

FIG. 1

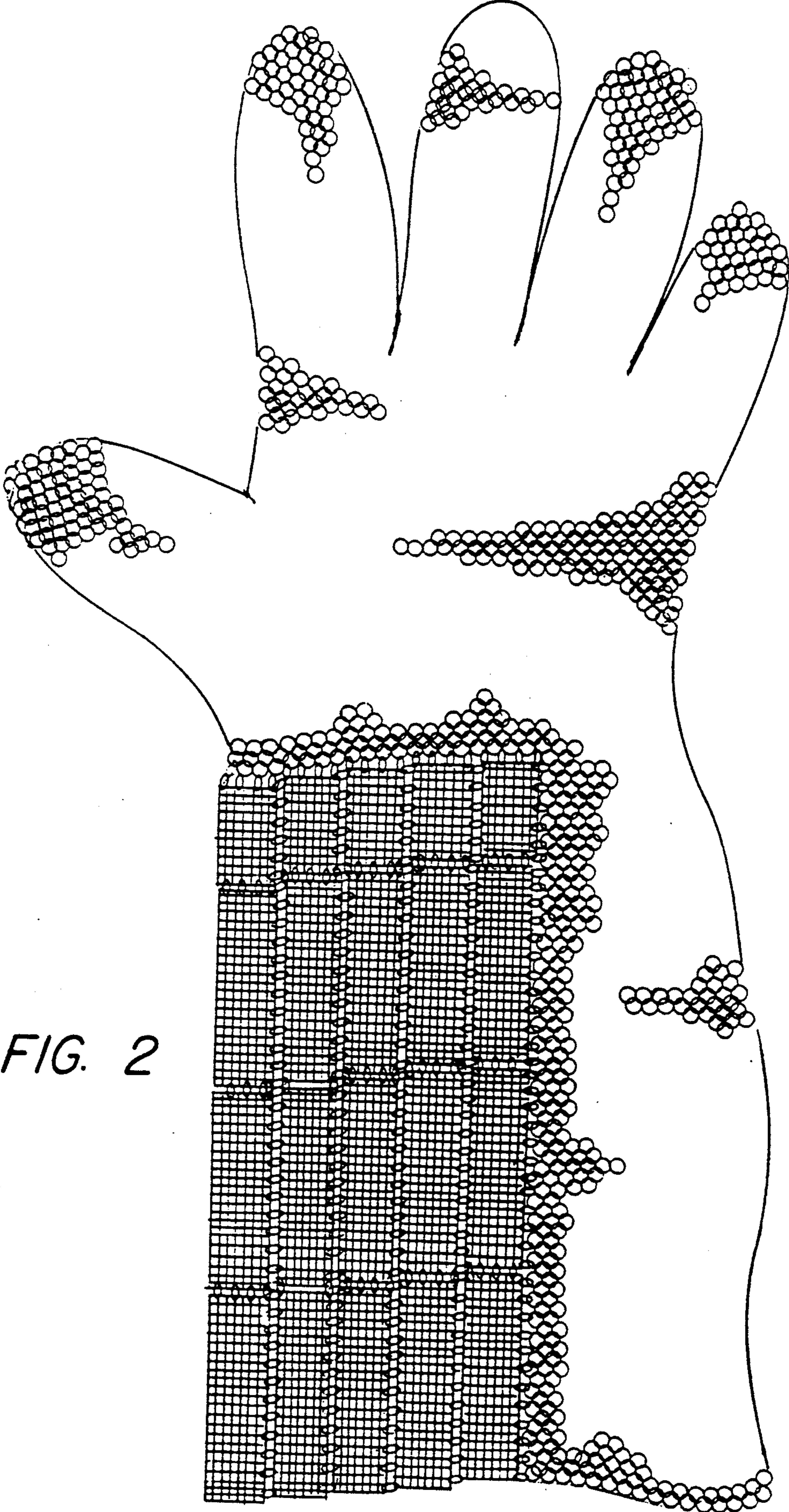

FIG. 2

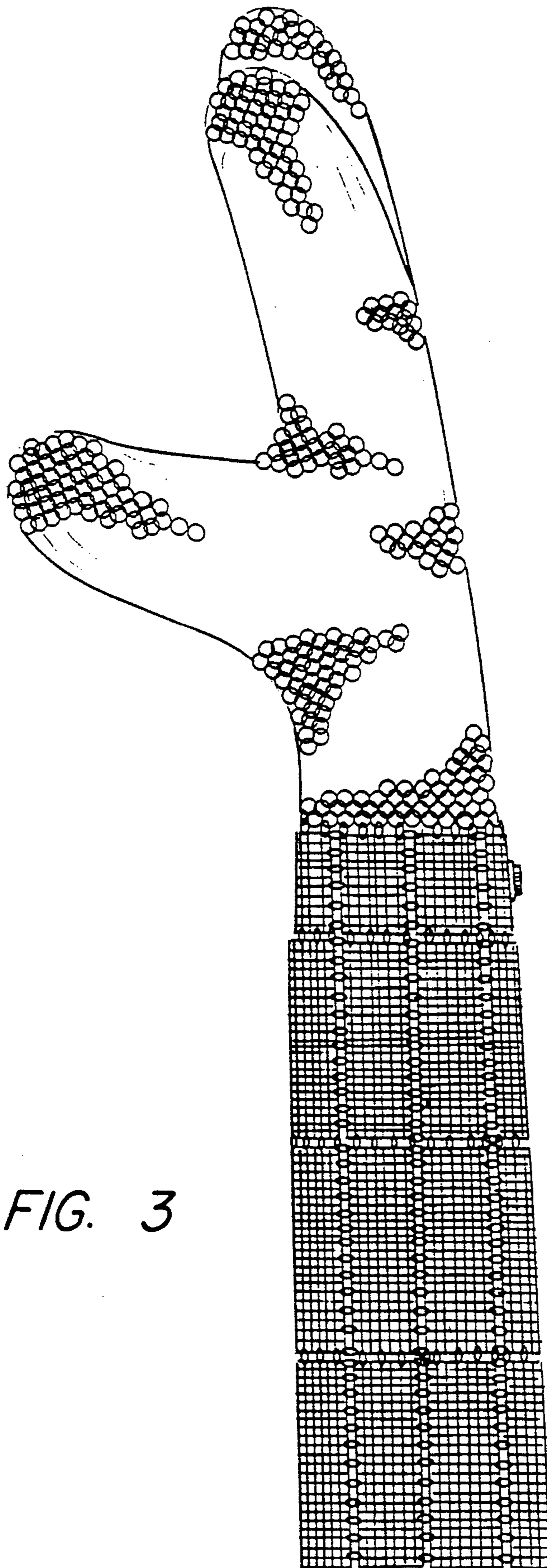

FIG. 3

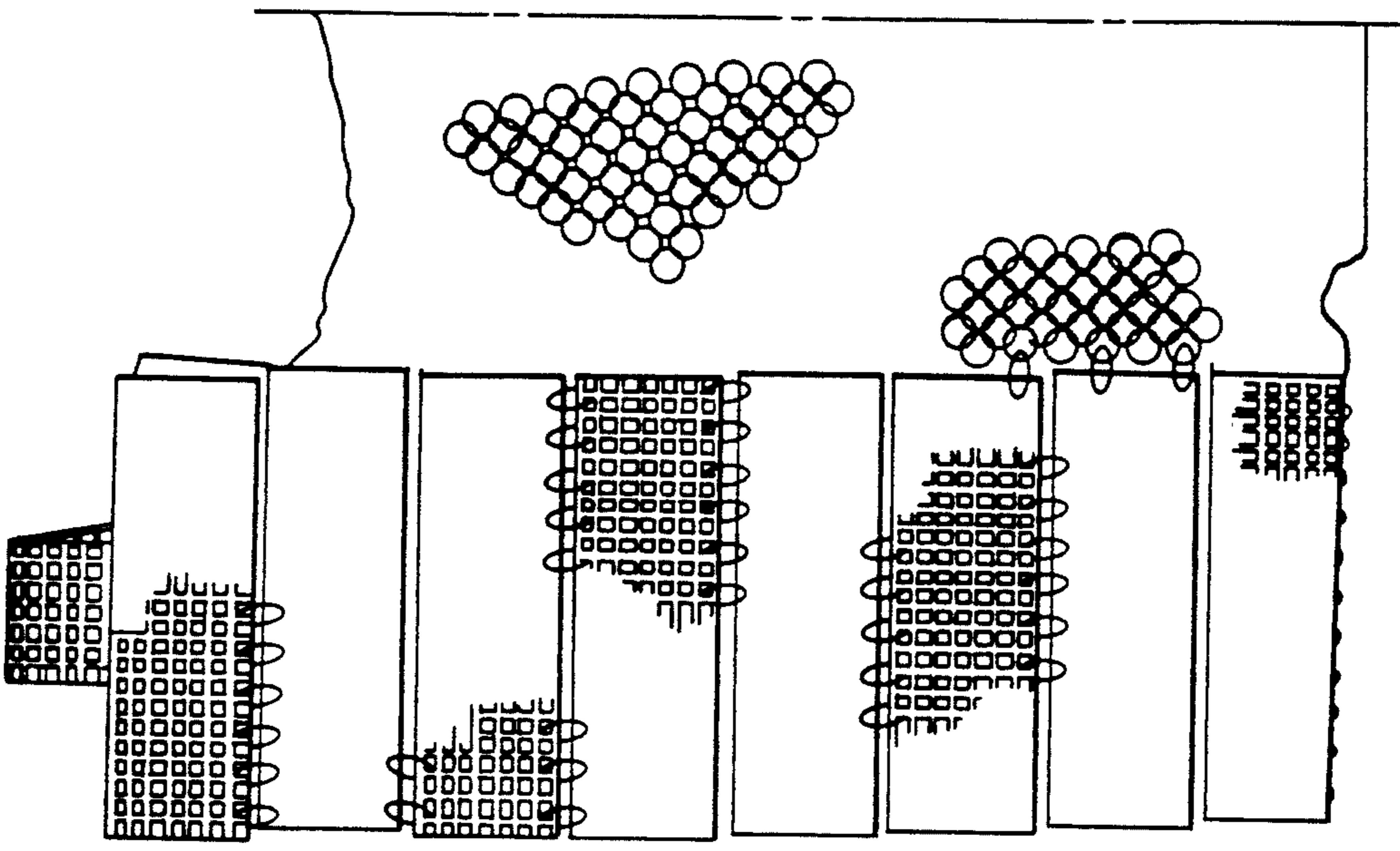

FIG. 7

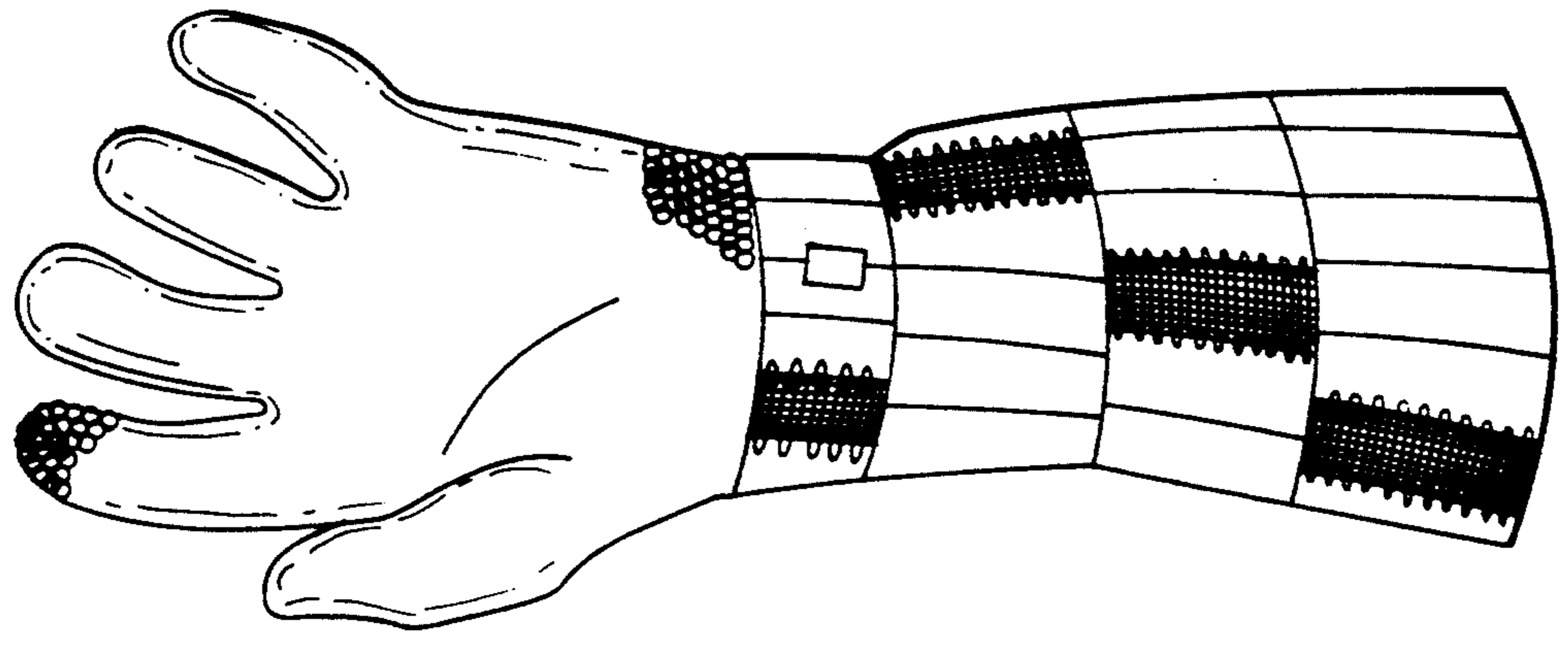

FIG. 4

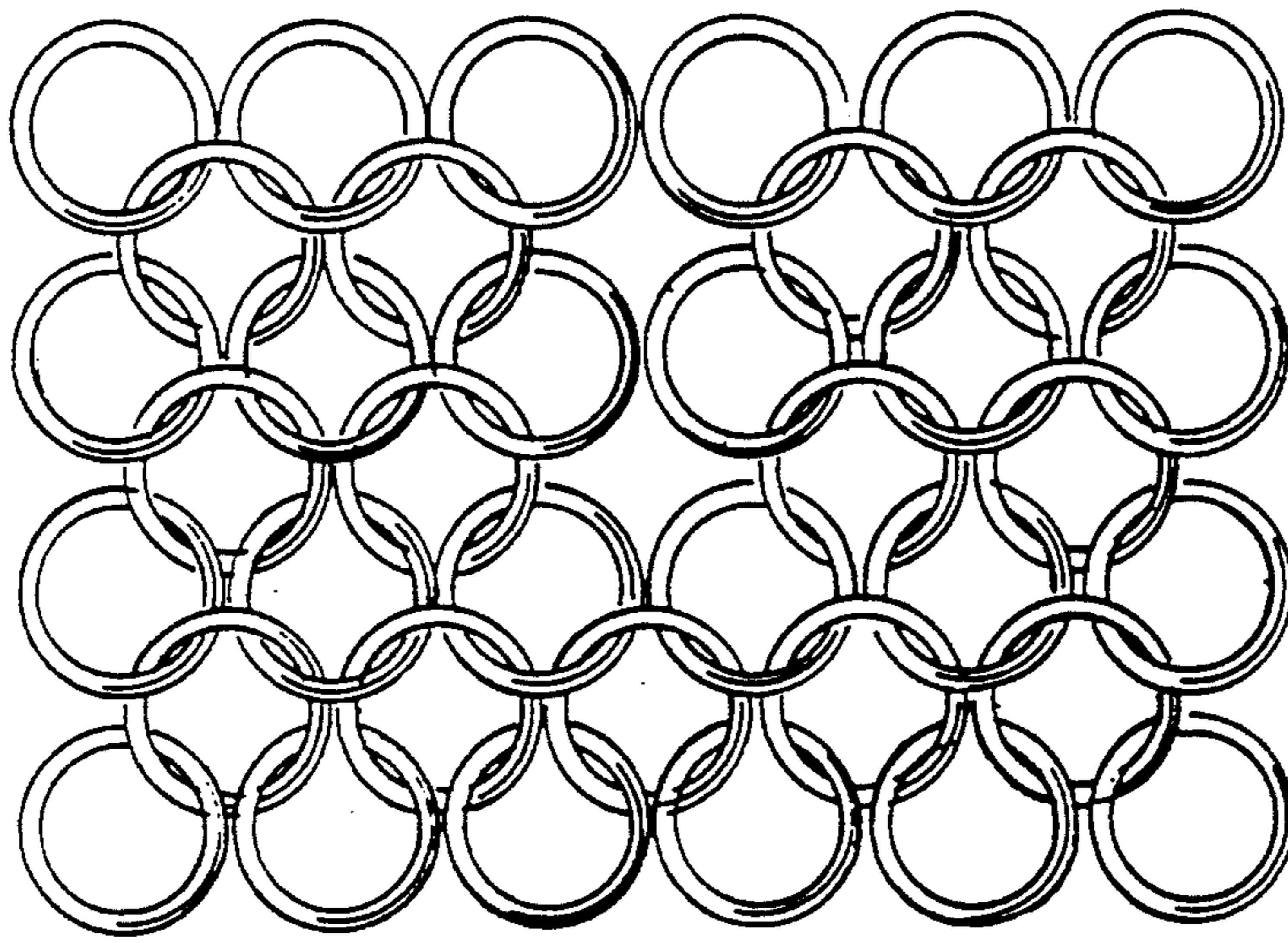

FIG. 5

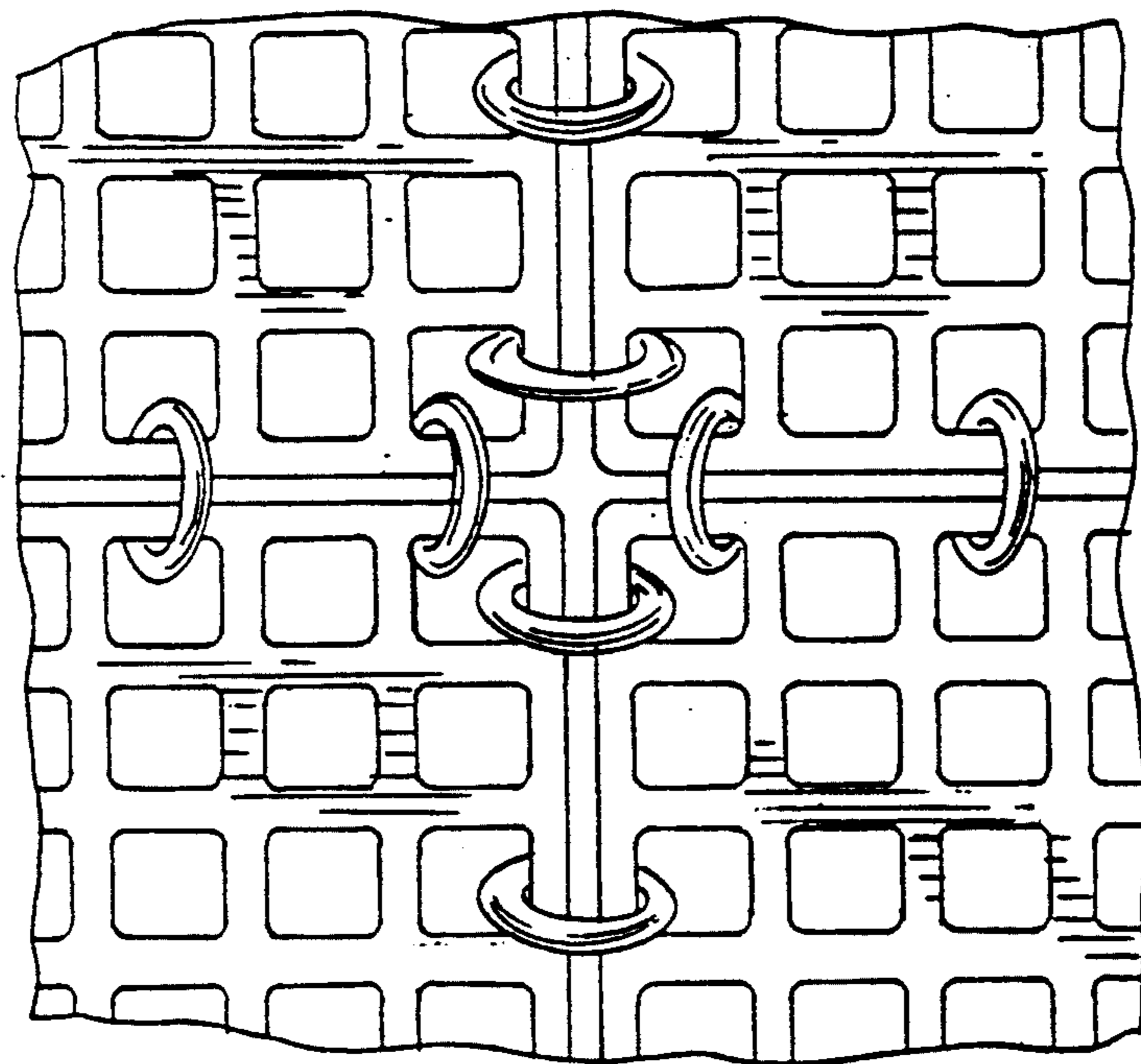

FIG. 6

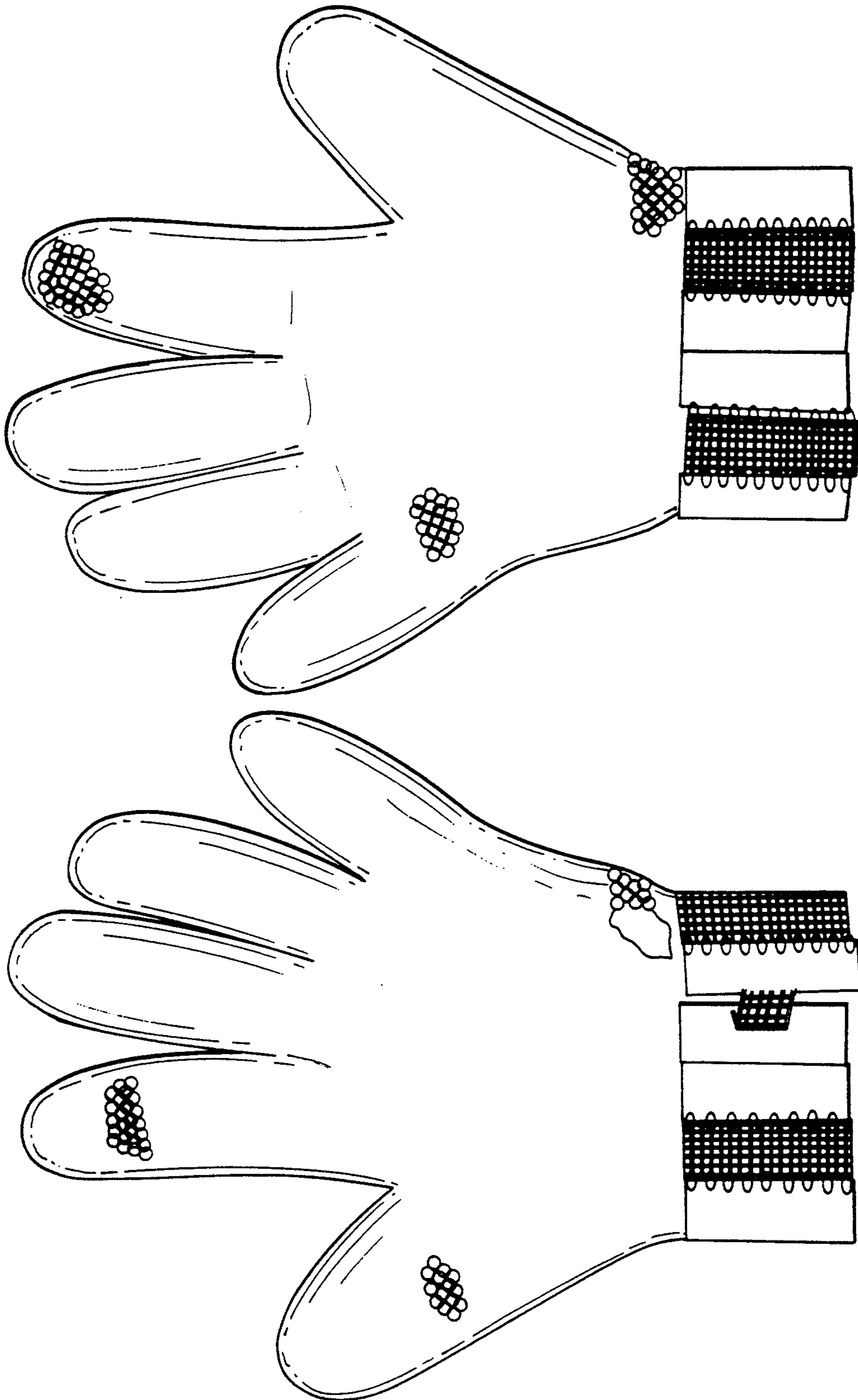

FIG. 9

FIG. 8

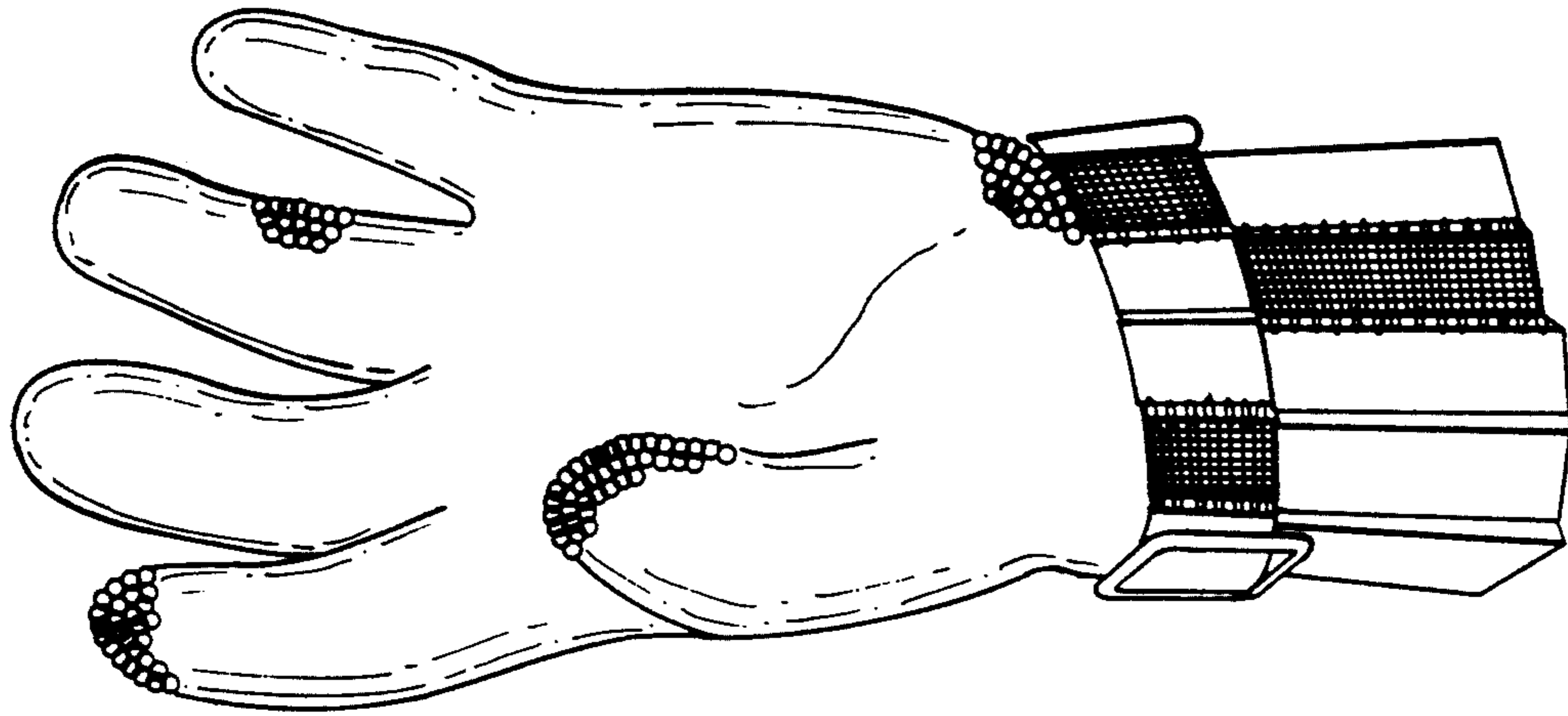

FIG. 11

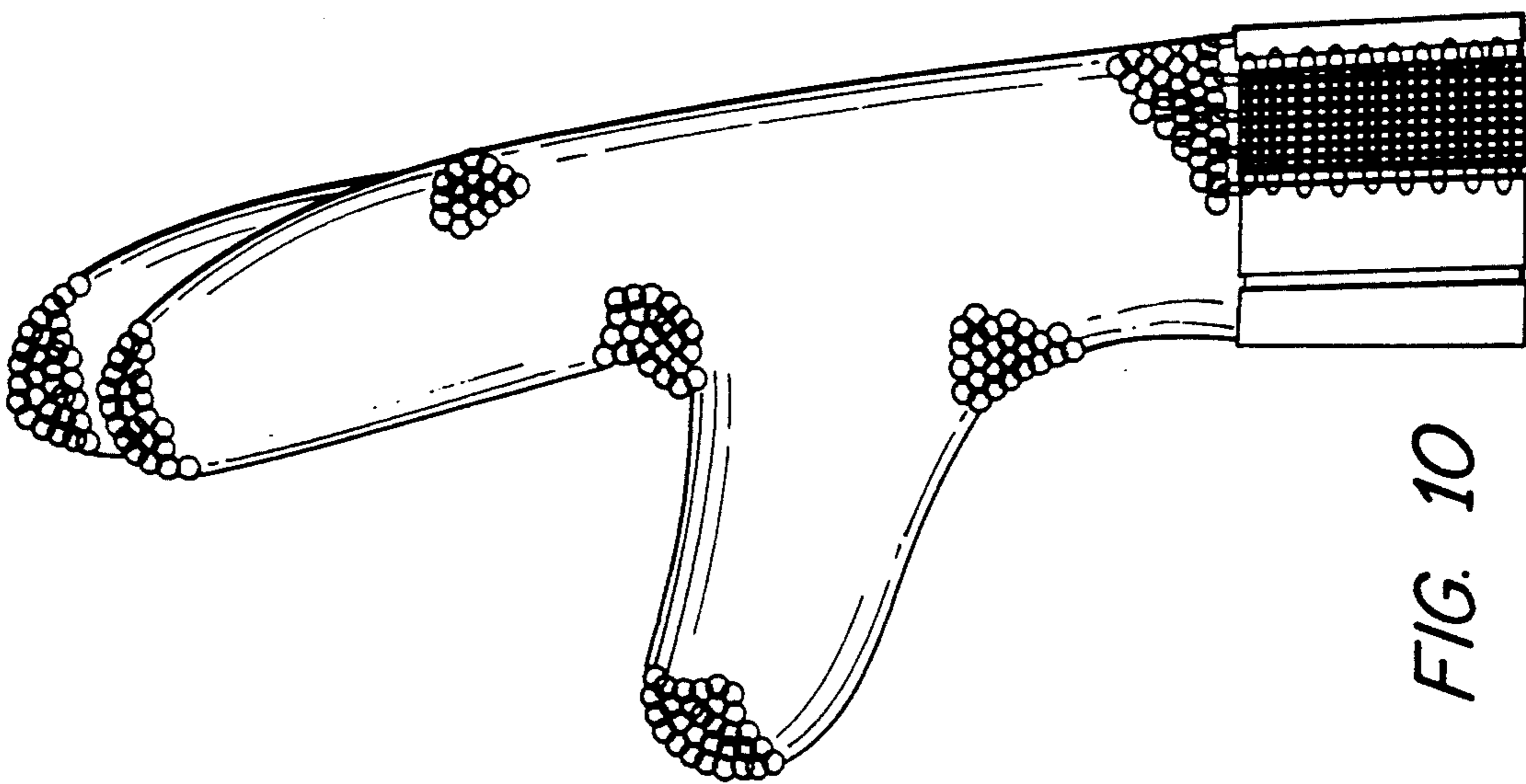

FIG. 10

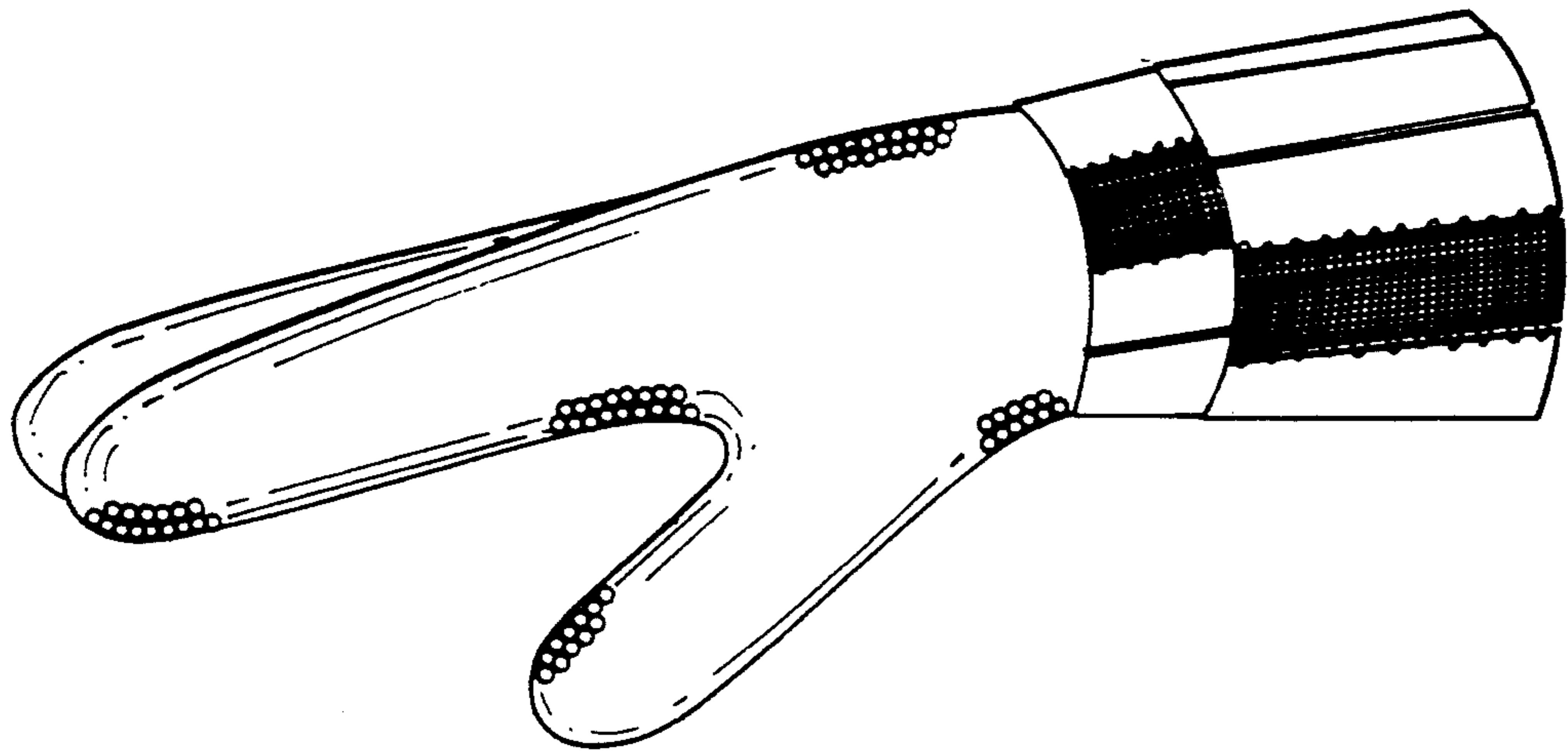

FIG. 13

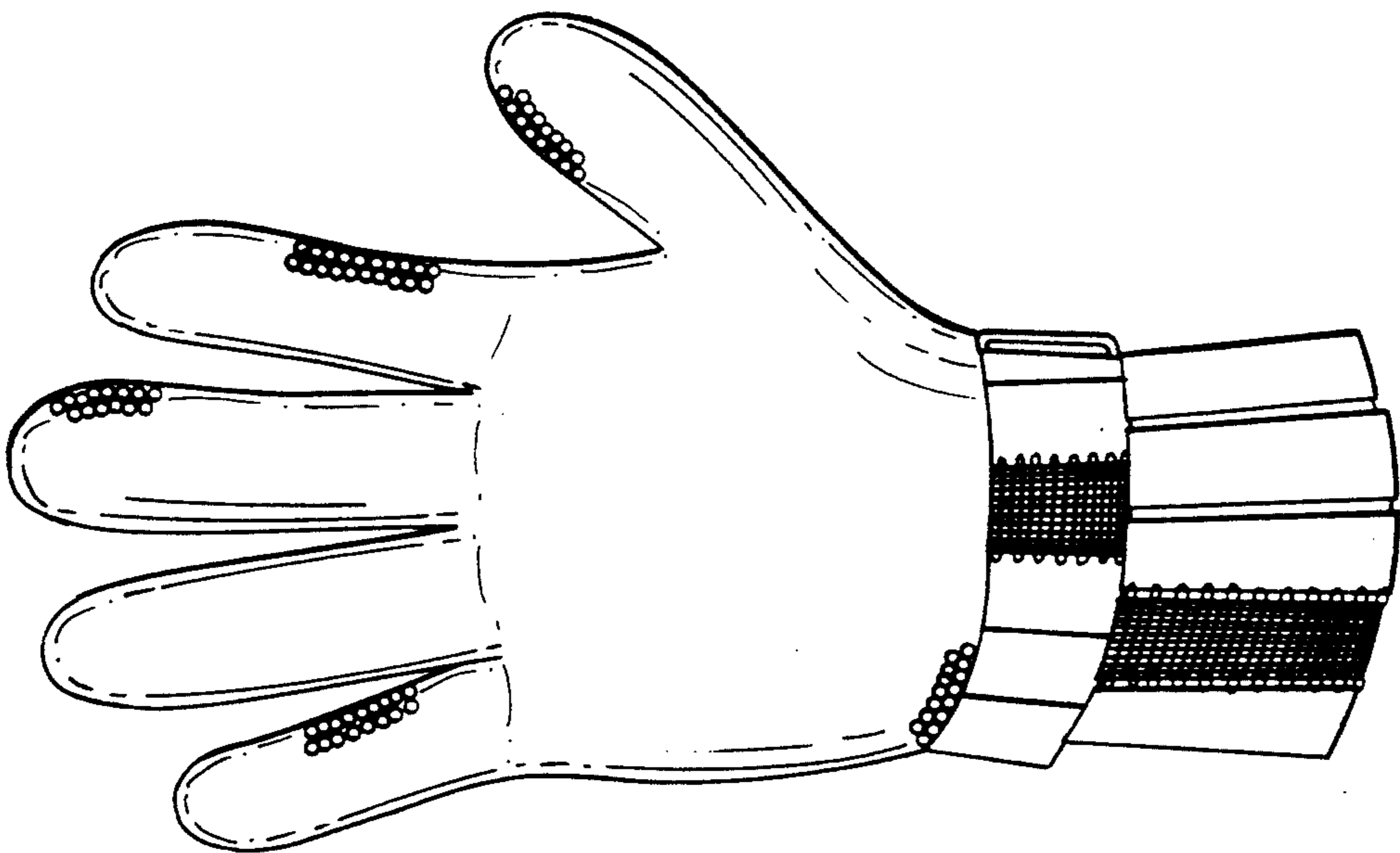

FIG. 12

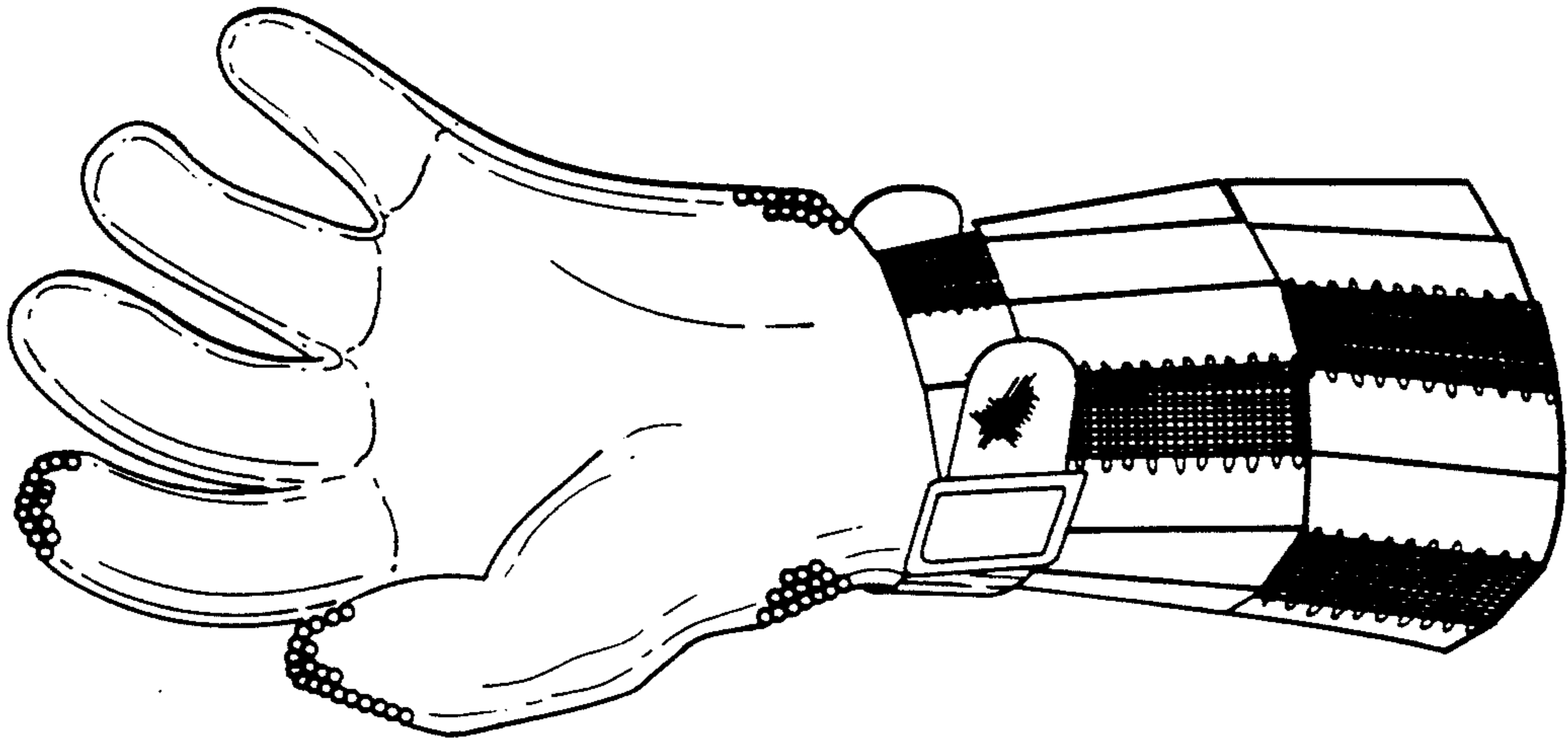

FIG. 16

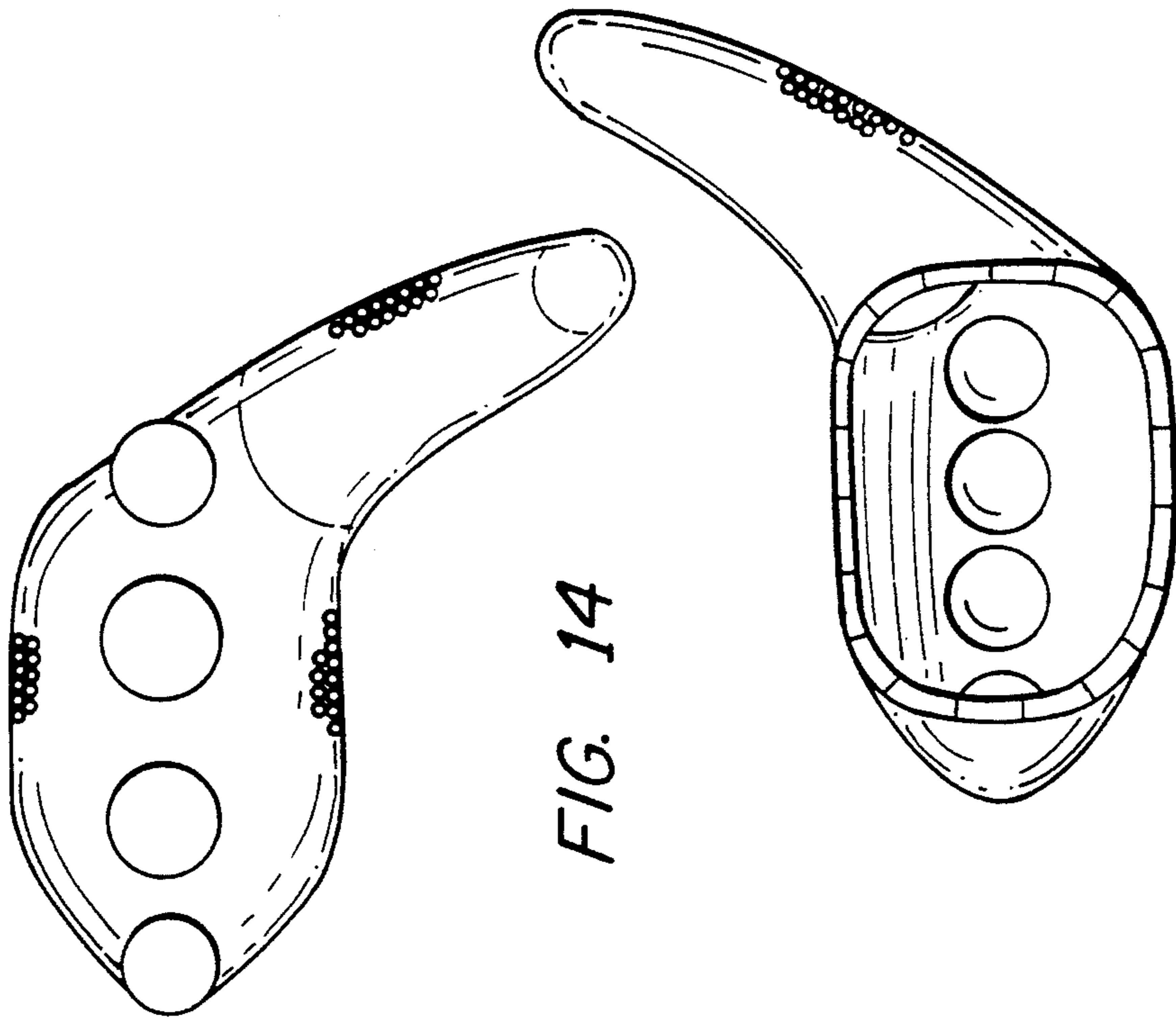

FIG. 14

FIG. 15

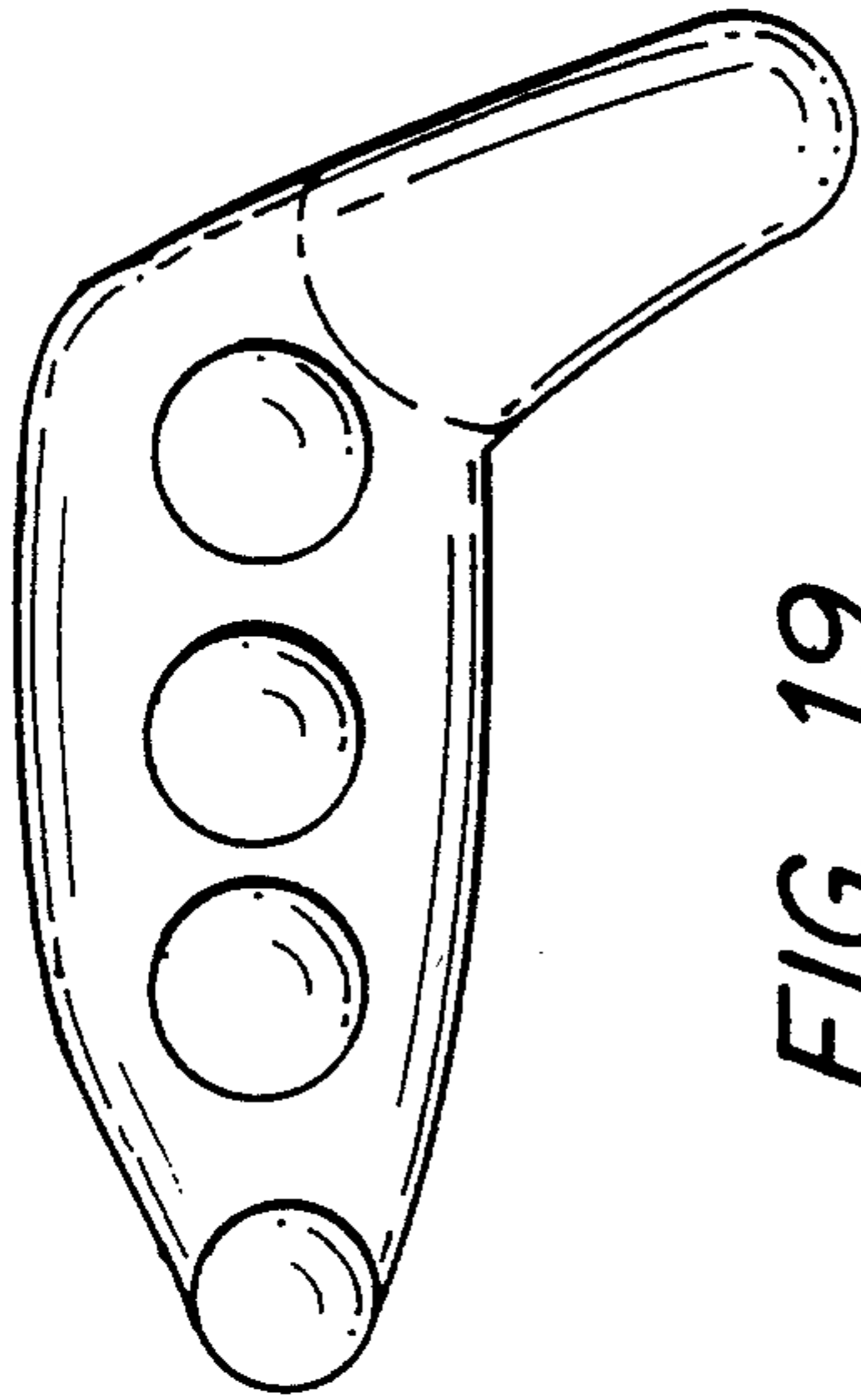

FIG. 19

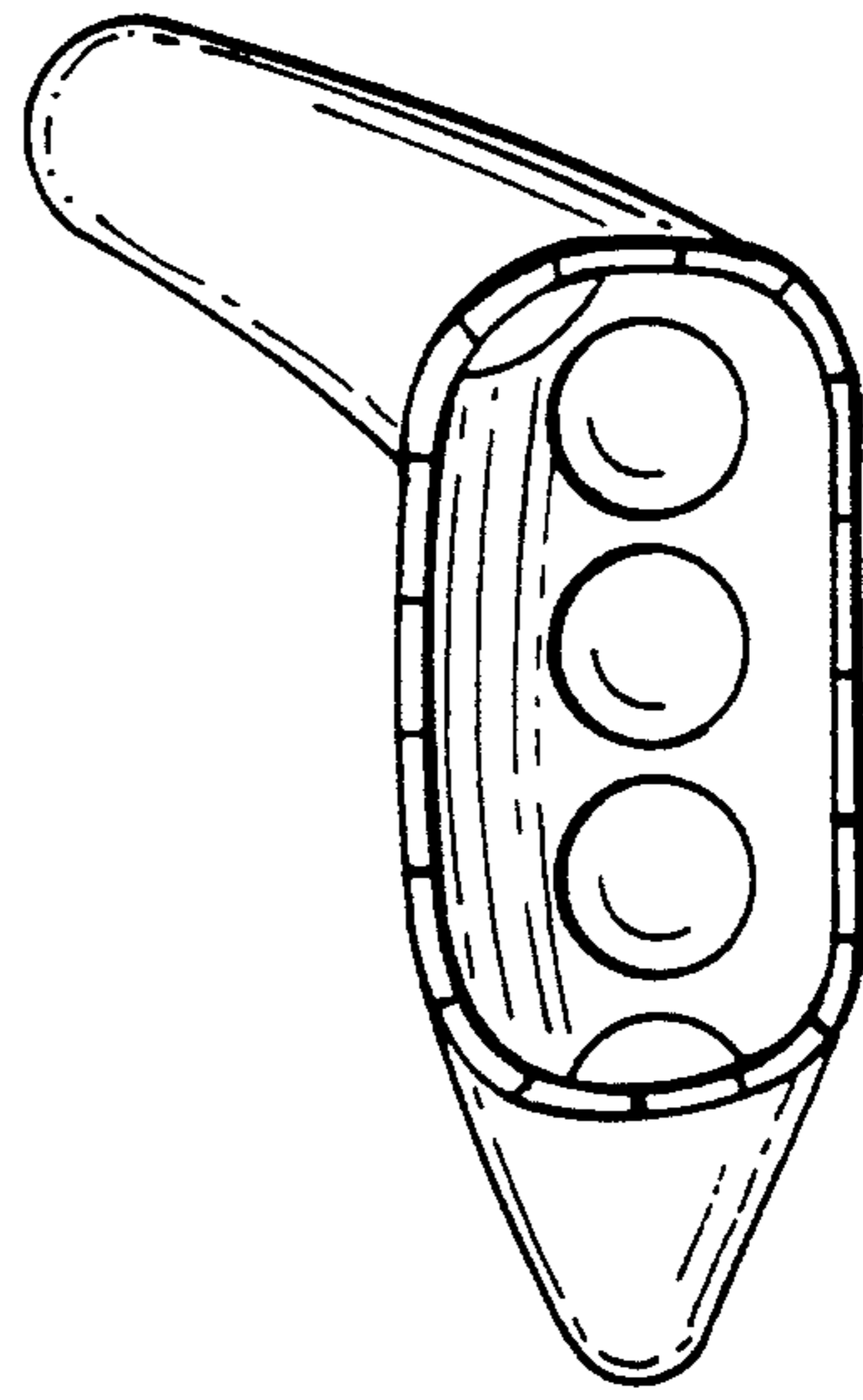

FIG. 20

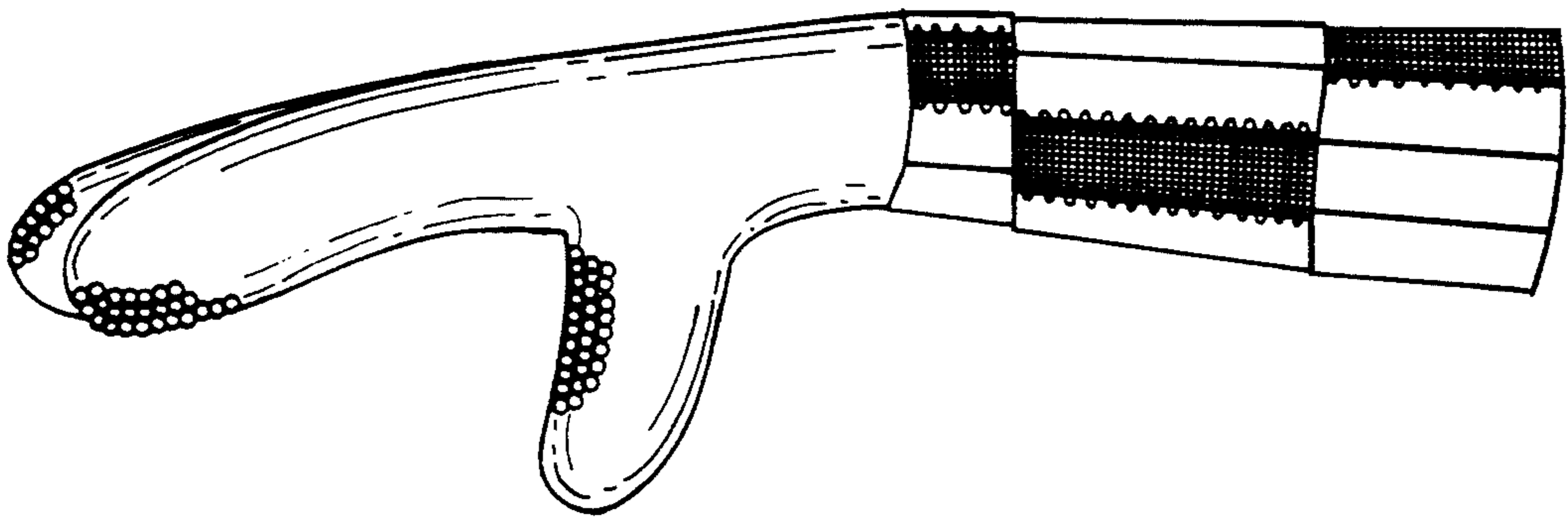

FIG. 18

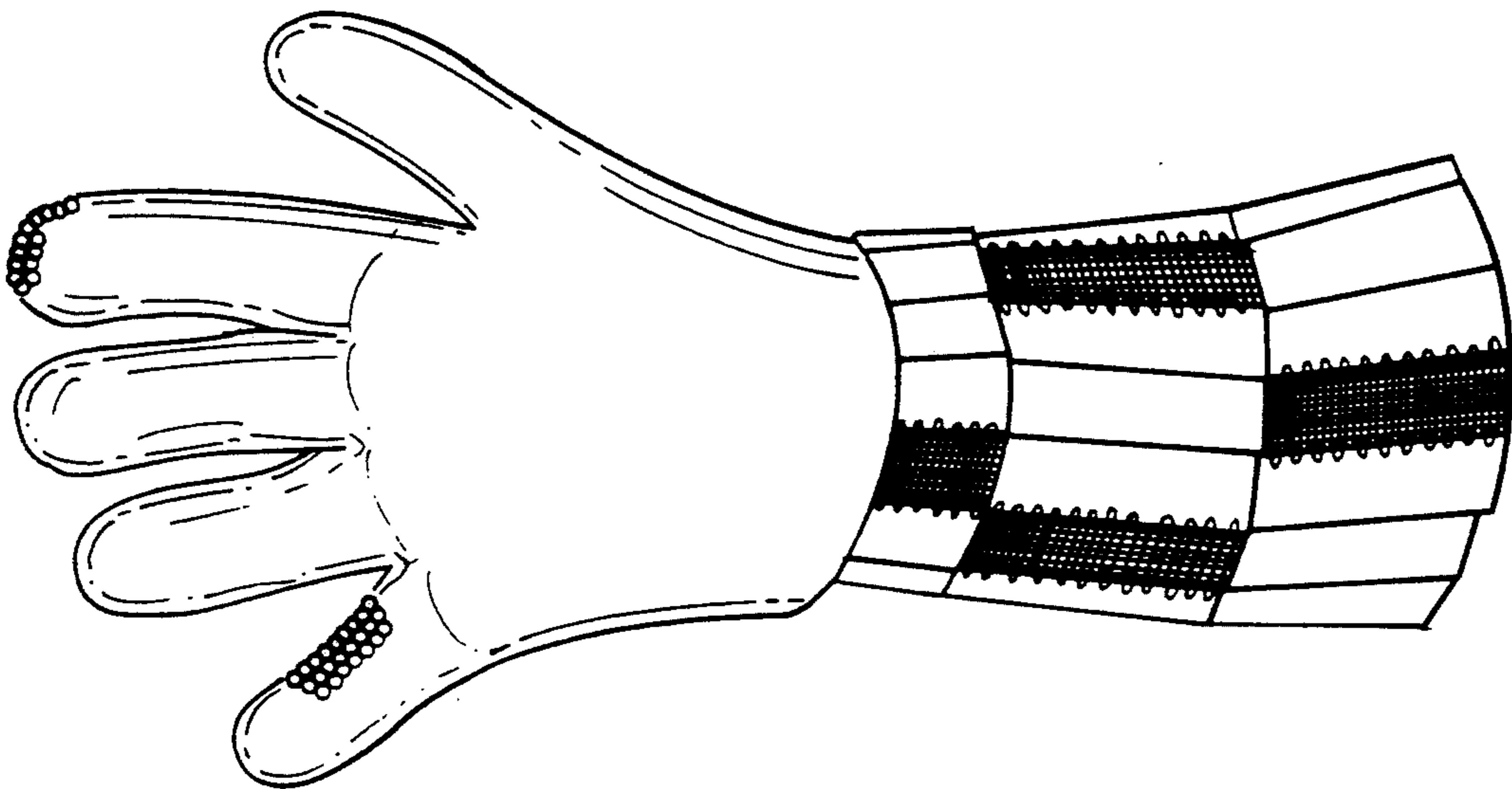

FIG. 17

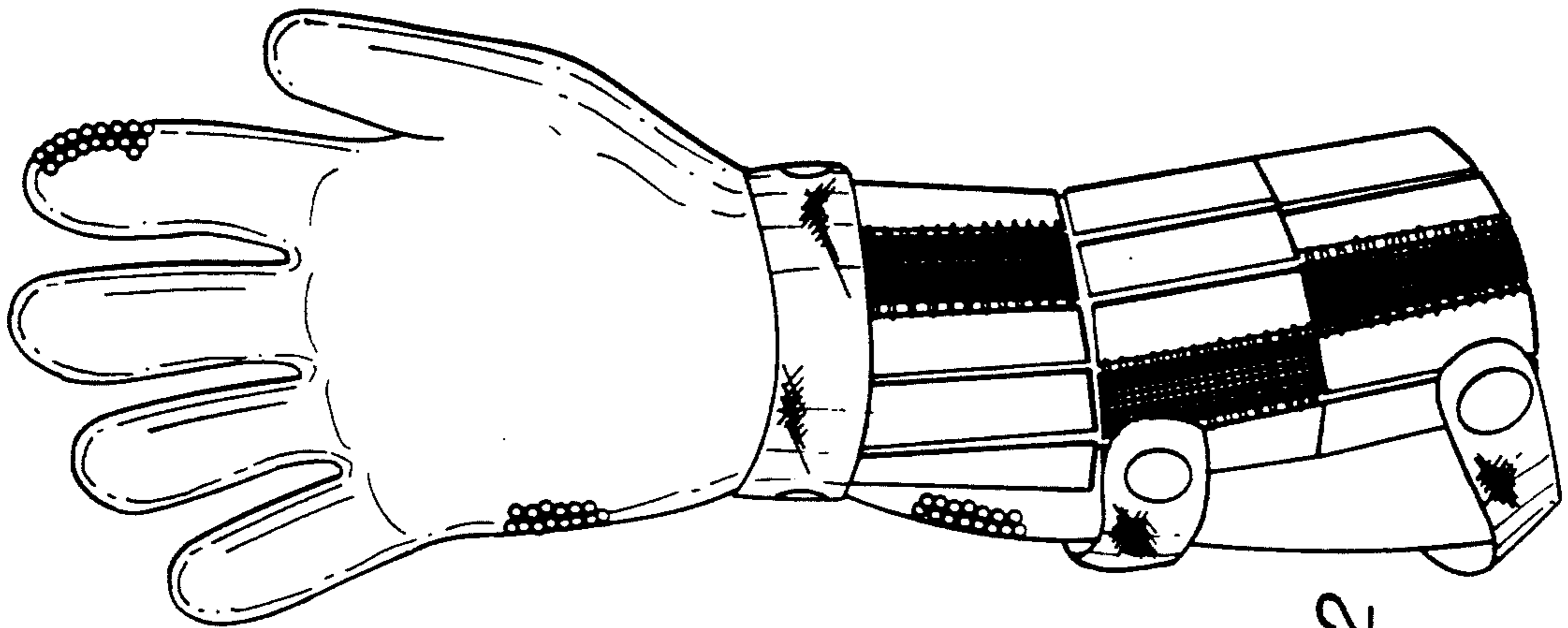

FIG. 22

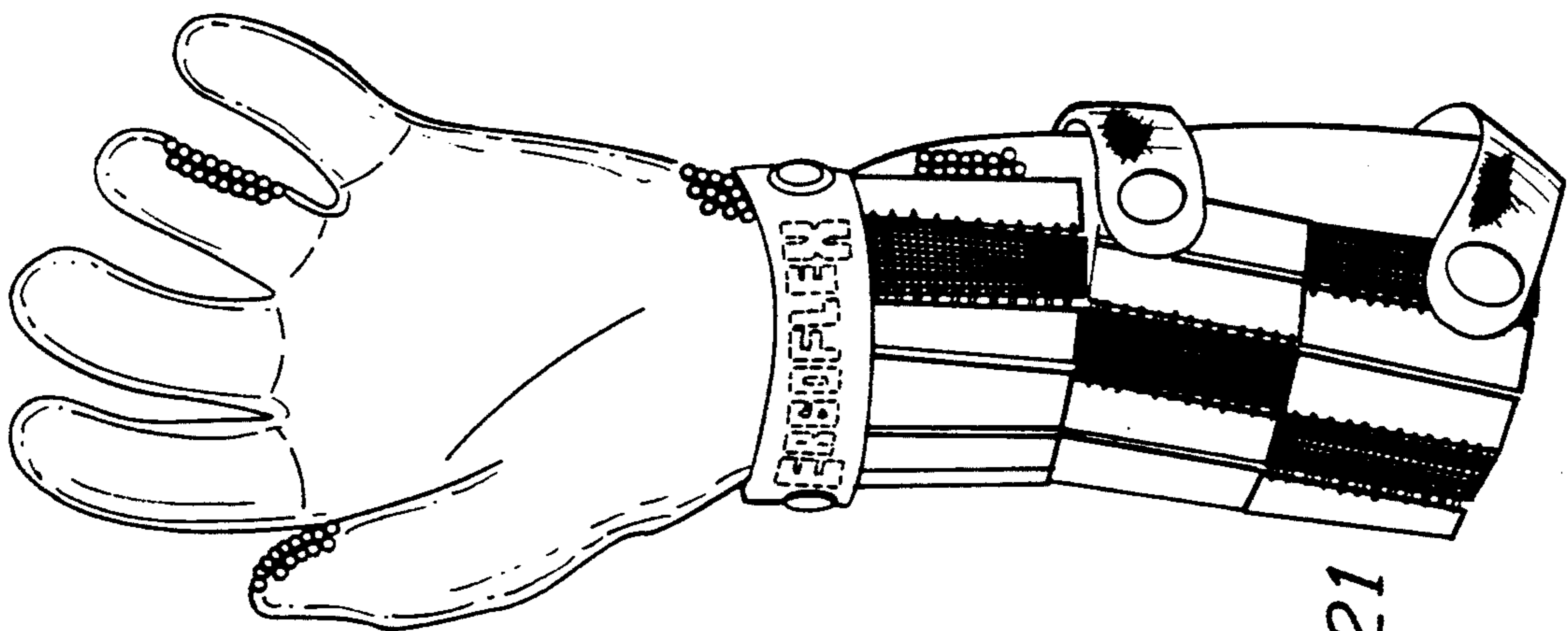

FIG. 21

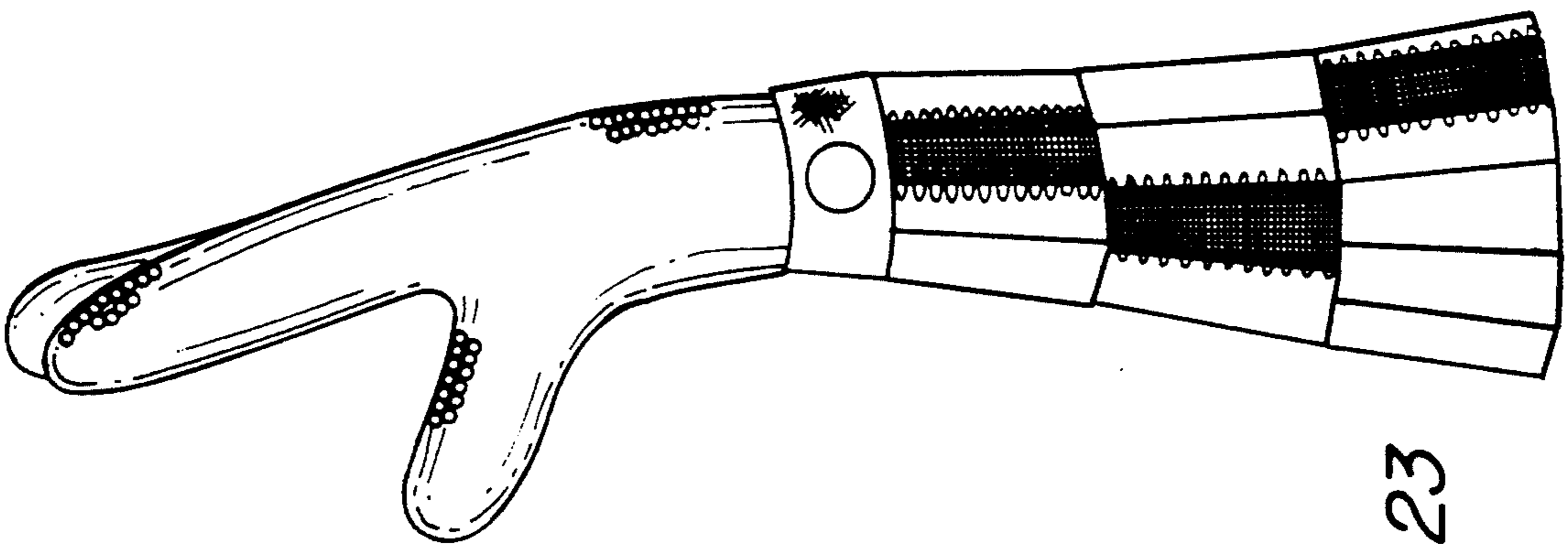

FIG. 23

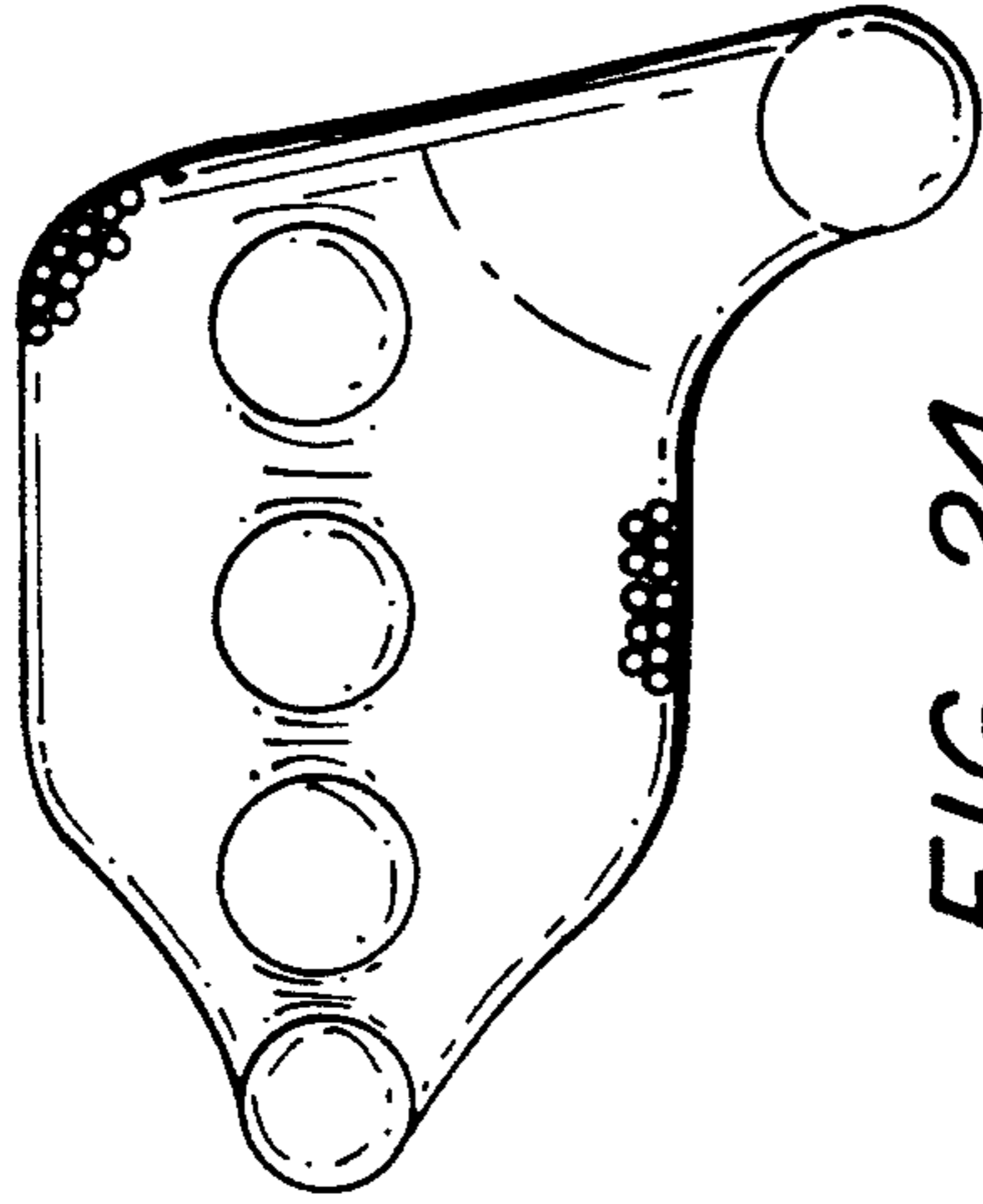

FIG. 24

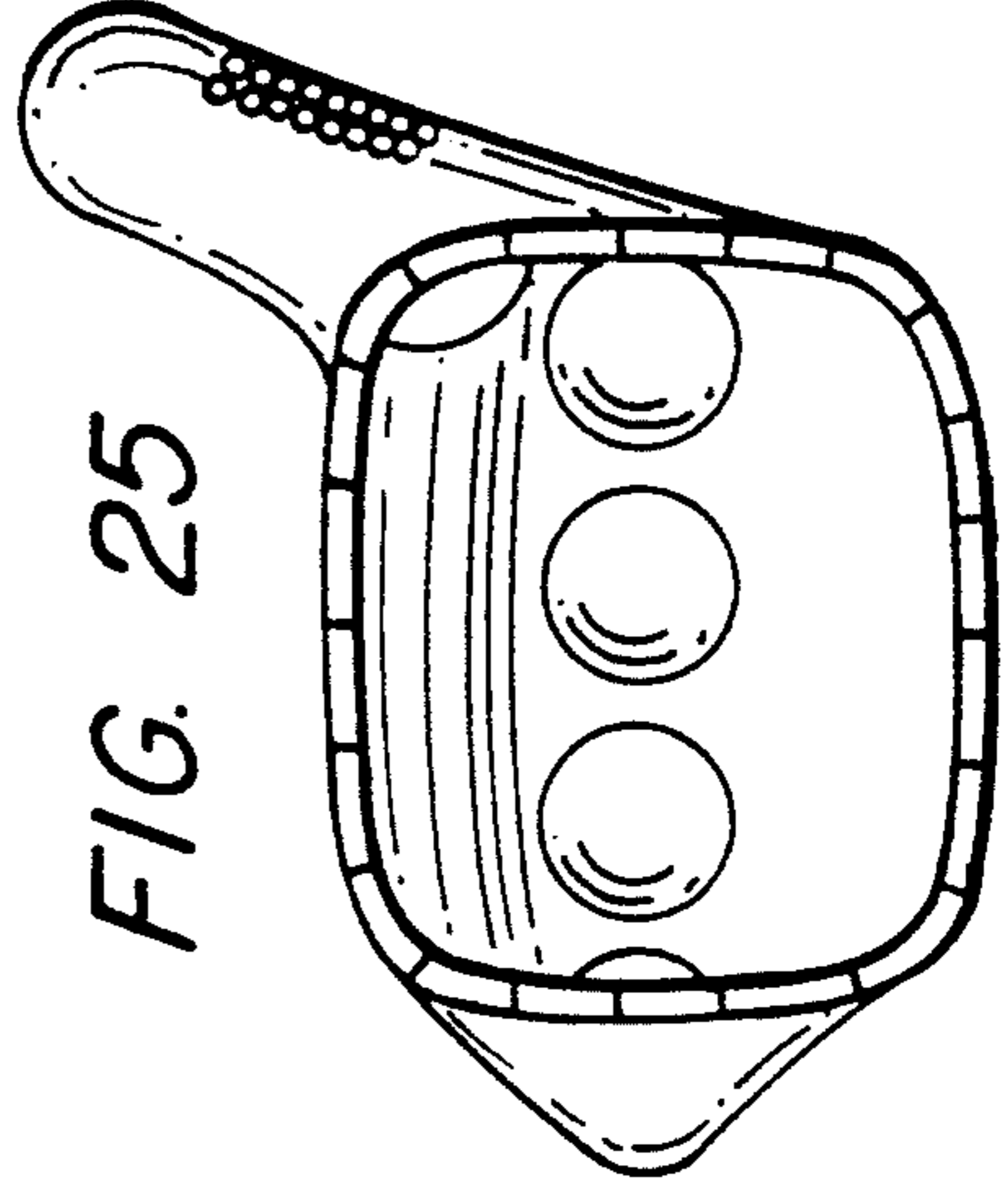

FIG. 25

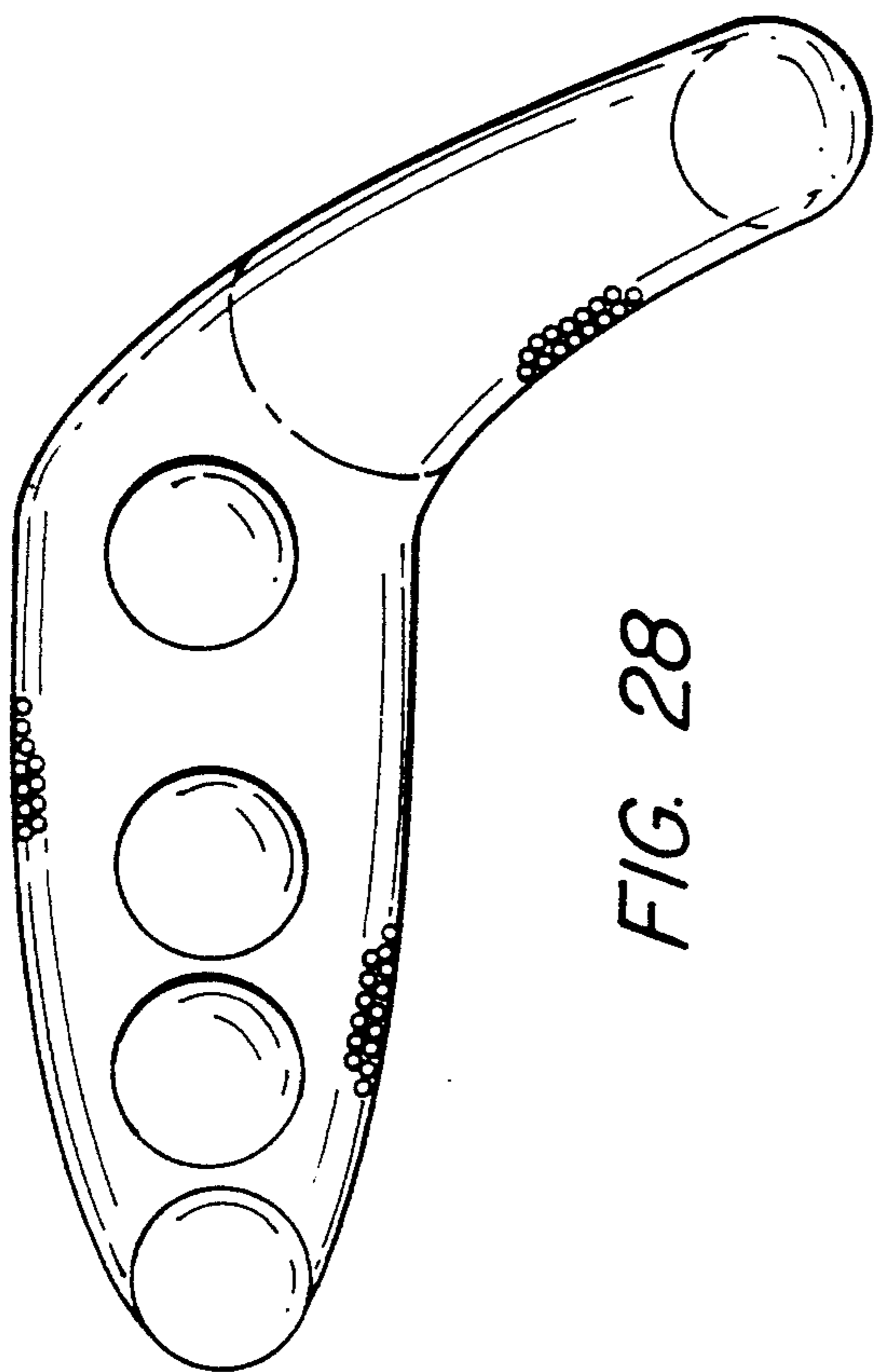

FIG. 28

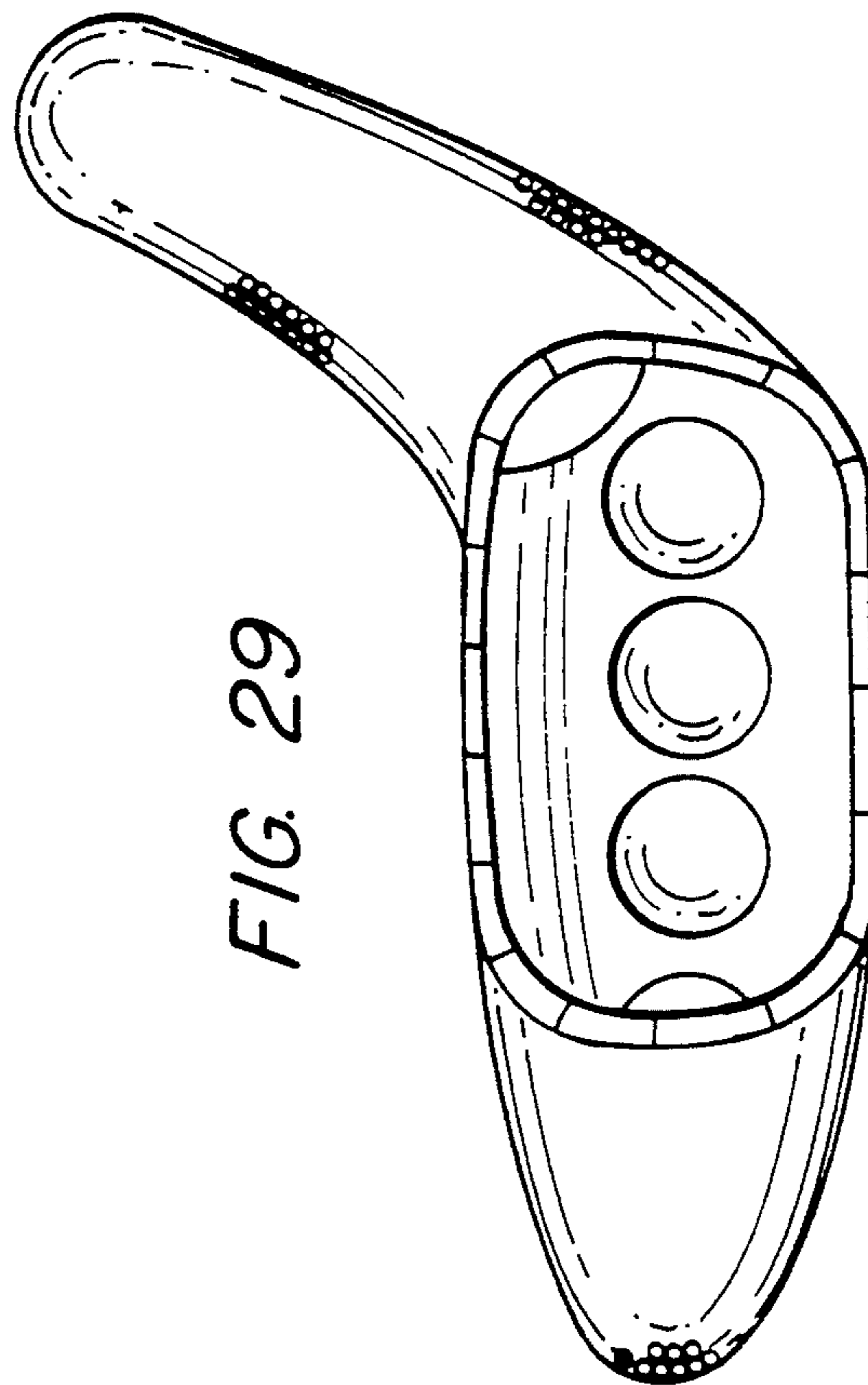

FIG. 29

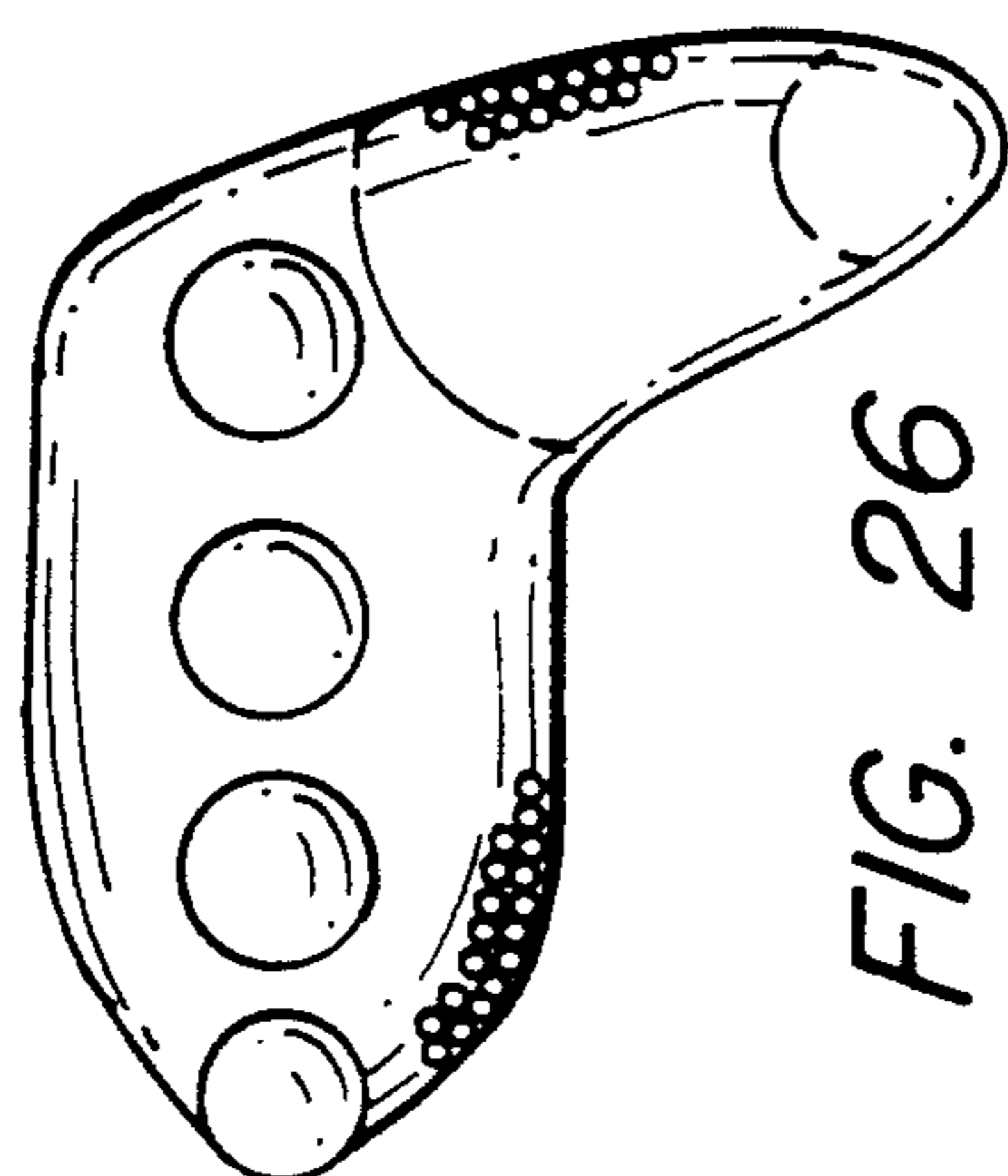

FIG. 26

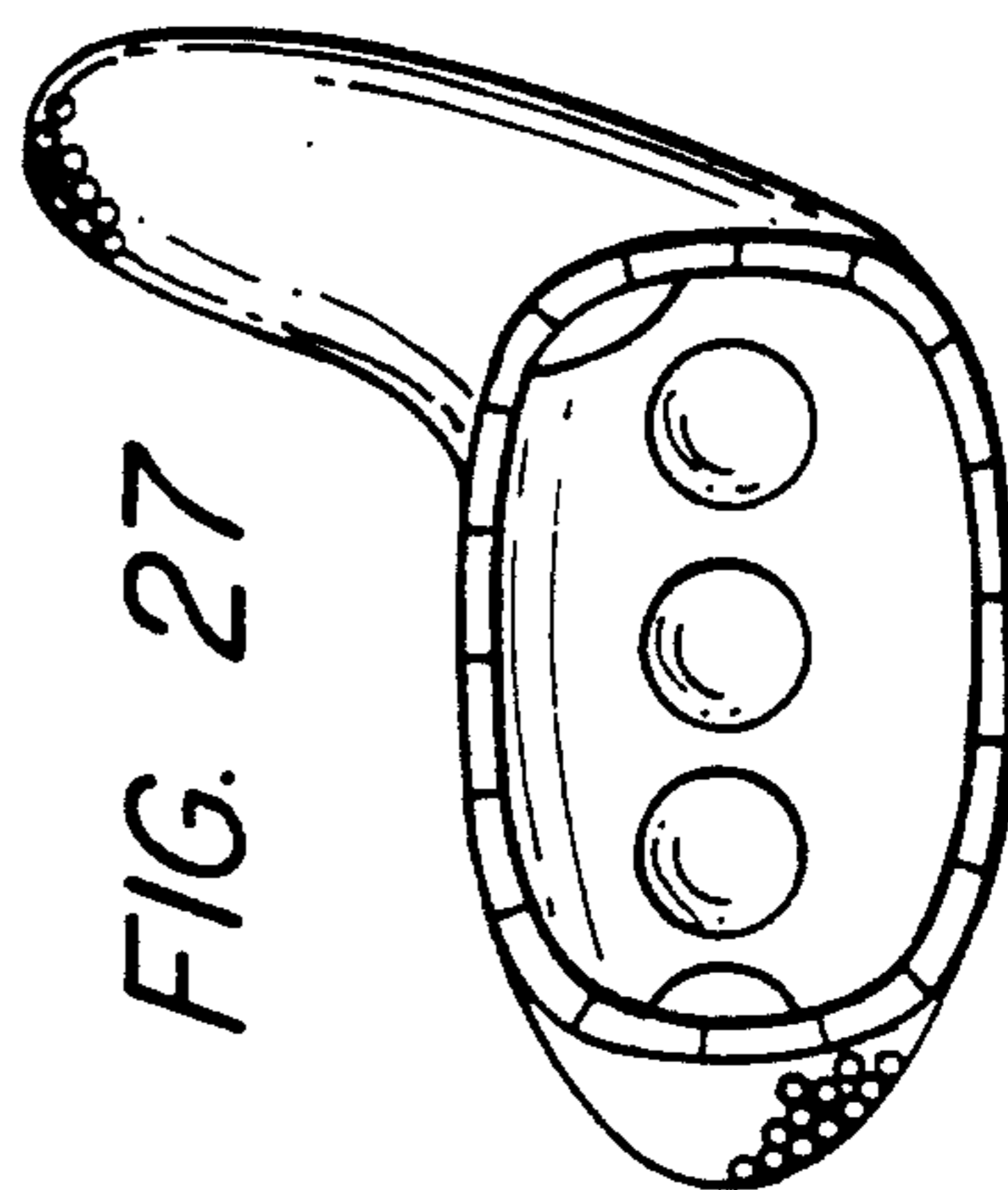

FIG. 27