



US00D347916S

# United States Patent [19]

[11] Patent Number: **Des. 347,916**

Russ

[45] Date of Patent: **\*\* Jun. 14, 1994**

[54] **COMBINED TRASH BINS AND CART THEREFOR**

*Primary Examiner—Kay H. Chin  
Attorney, Agent, or Firm—Hugh E. Smith*

[76] Inventor: **Nathaniel C. Russ, 1561 NW. 33rd Ter., Ft. Lauderdale, Fla. 33311**

[57] **CLAIM**

The ornamental design for a combined trash bins and cart therefor, as shown and described.

[\*\*] Term: **14 Years**

### DESCRIPTION

[21] Appl. No.: **836,462**

[22] Filed: **Feb. 18, 1992**

[52] U.S. Cl. .... **D34/5; D34/7**

[58] Field of Search ..... **220/909, 908; 232/1 R, 232/43.2; D34/1, 5**

FIG. 1 is a front elevational view of the combined trash bins and cart therefor showing my new design;  
FIG. 2 is a rear elevational view thereof;  
FIG. 3 is a left side elevational view thereof;  
FIG. 4 is a right side elevational view thereof;  
FIG. 5 is a top plan view thereof;  
FIG. 6 is a bottom plan view thereof;  
FIG. 7 is an exploded orthographic side view thereof;  
and,  
FIG. 8 is an upper right perspective view thereof.

[56] **References Cited**

### U.S. PATENT DOCUMENTS

- D. 329,516 9/1992 Bailly ..... D34/5
- D. 330,789 11/1992 Powell ..... D34/5

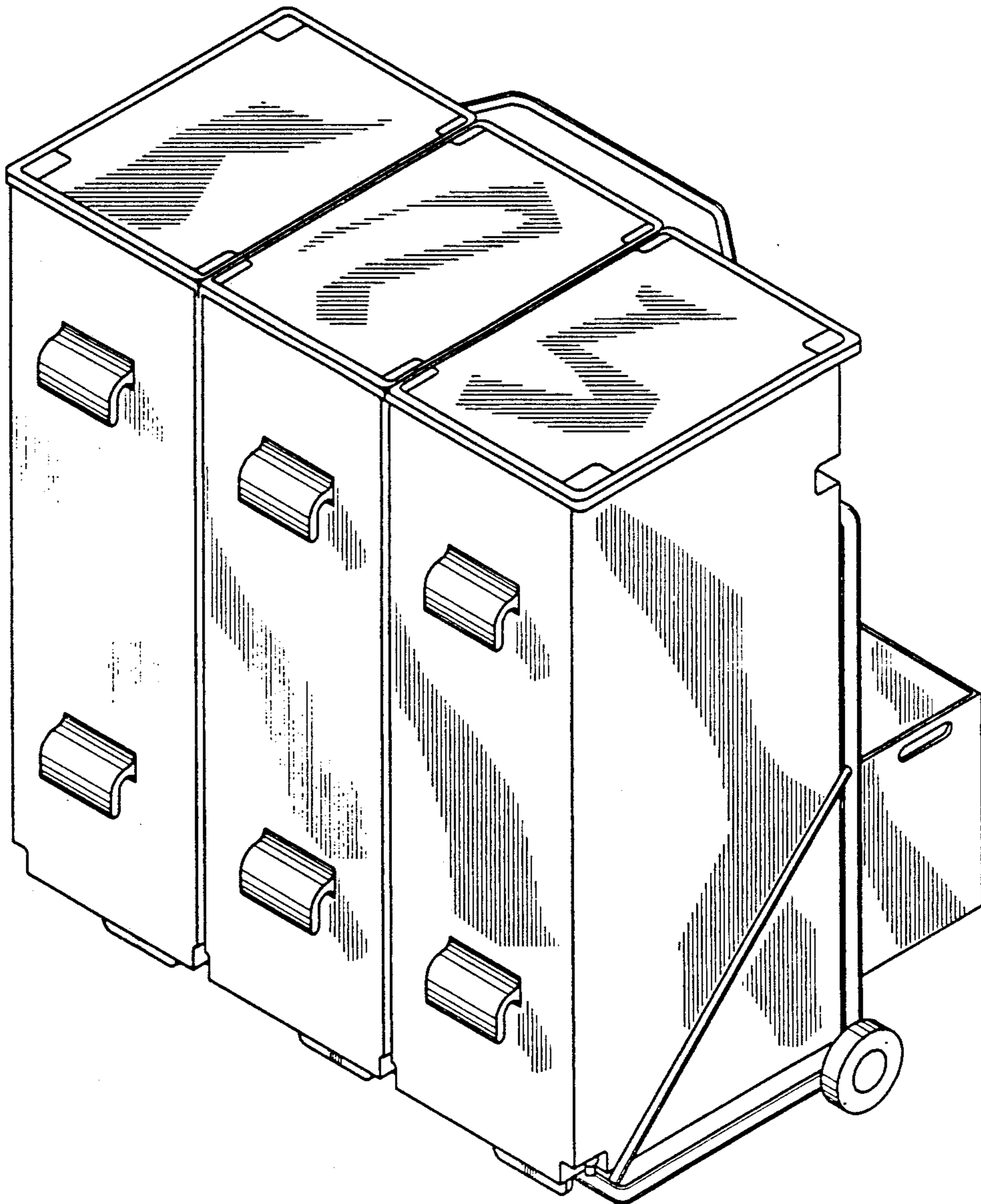

FIG. 1

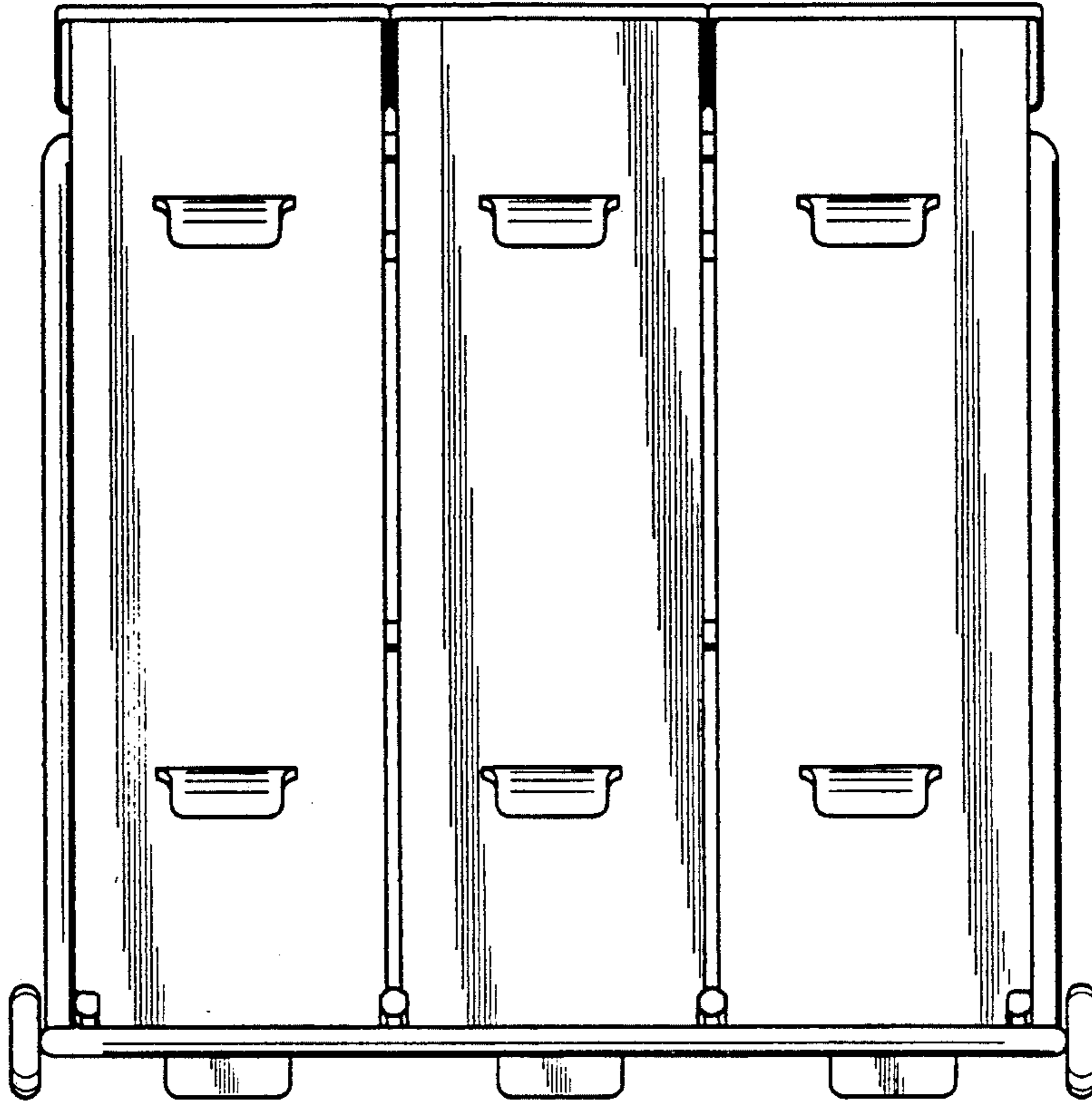

FIG. 2

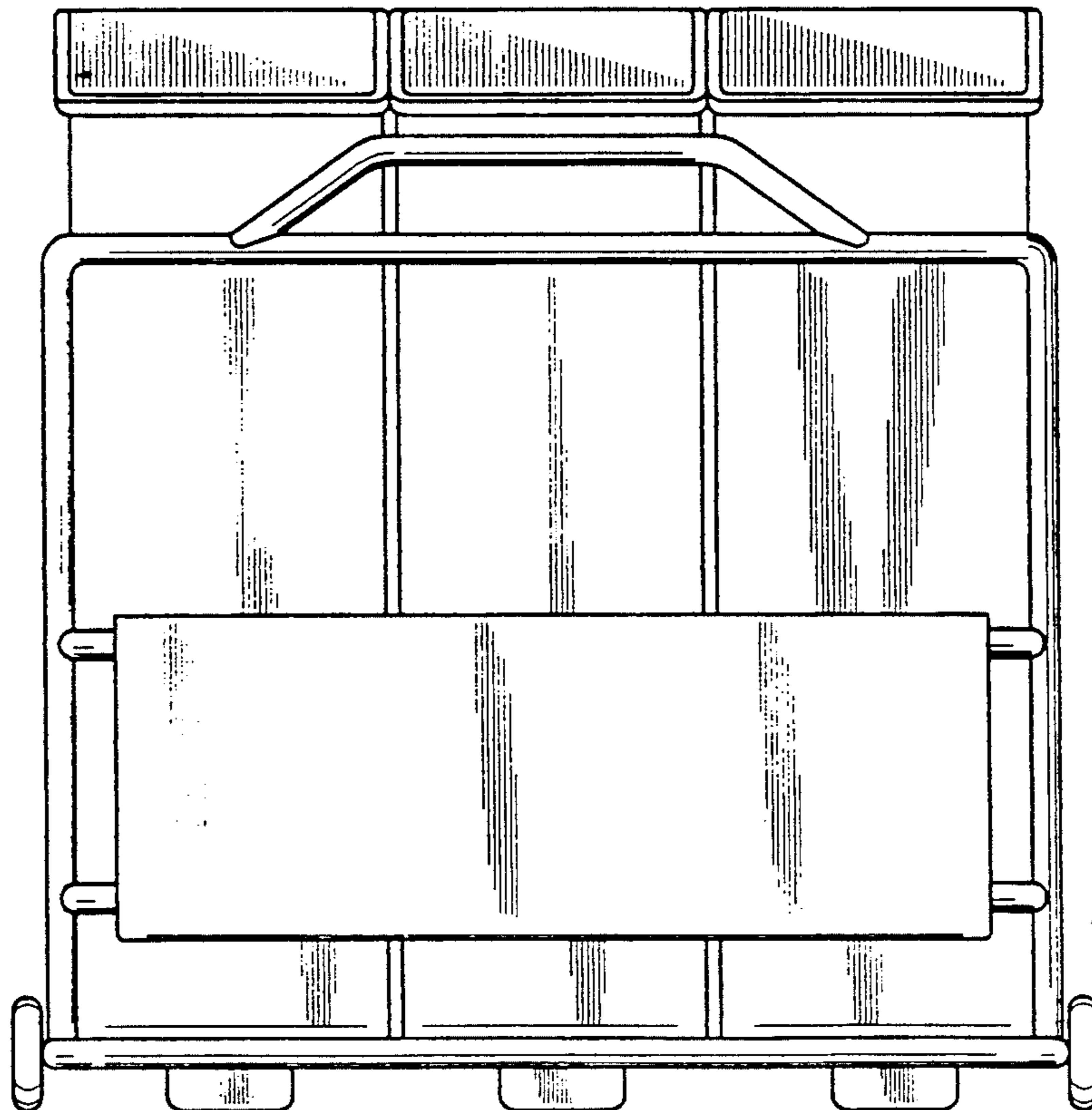

FIG. 3

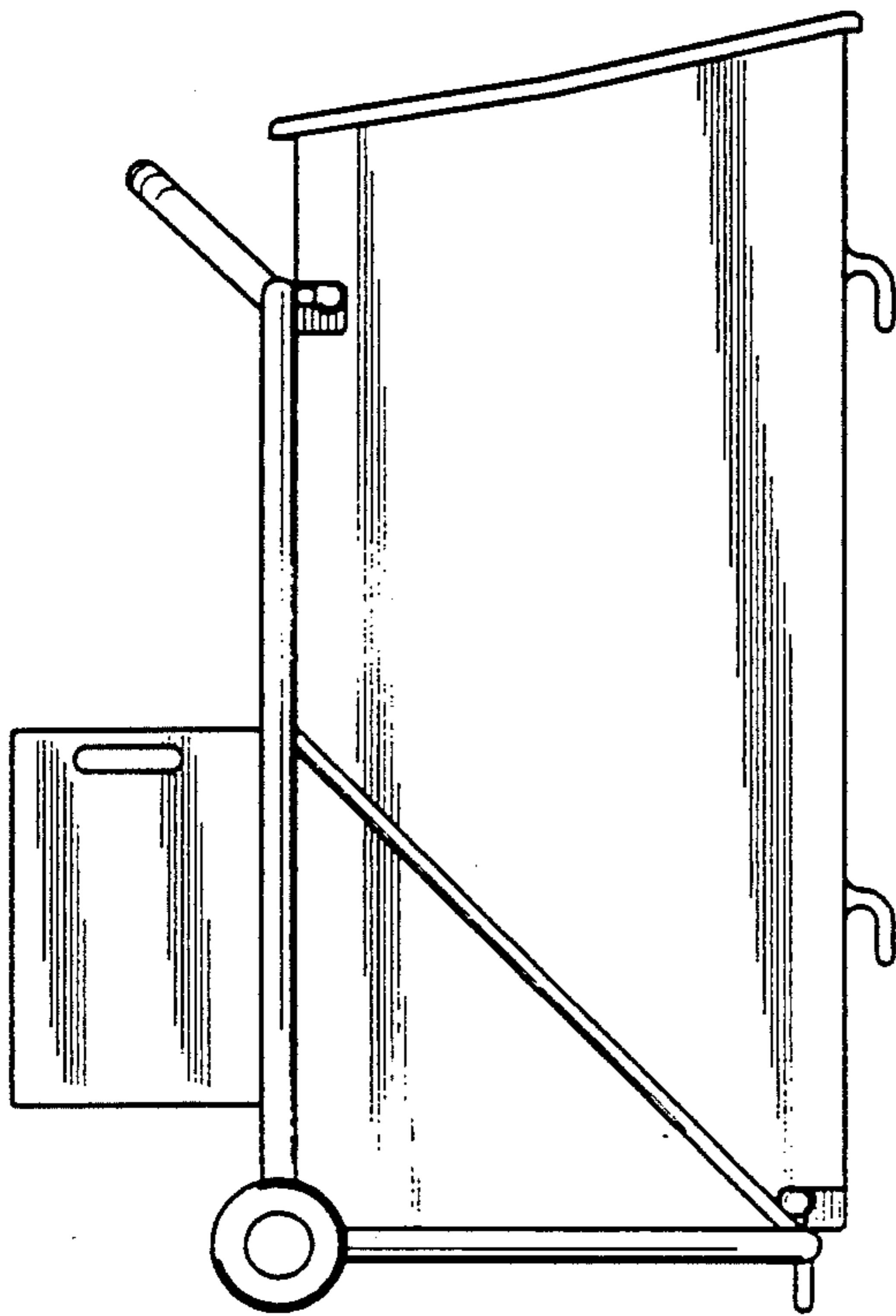

FIG. 4

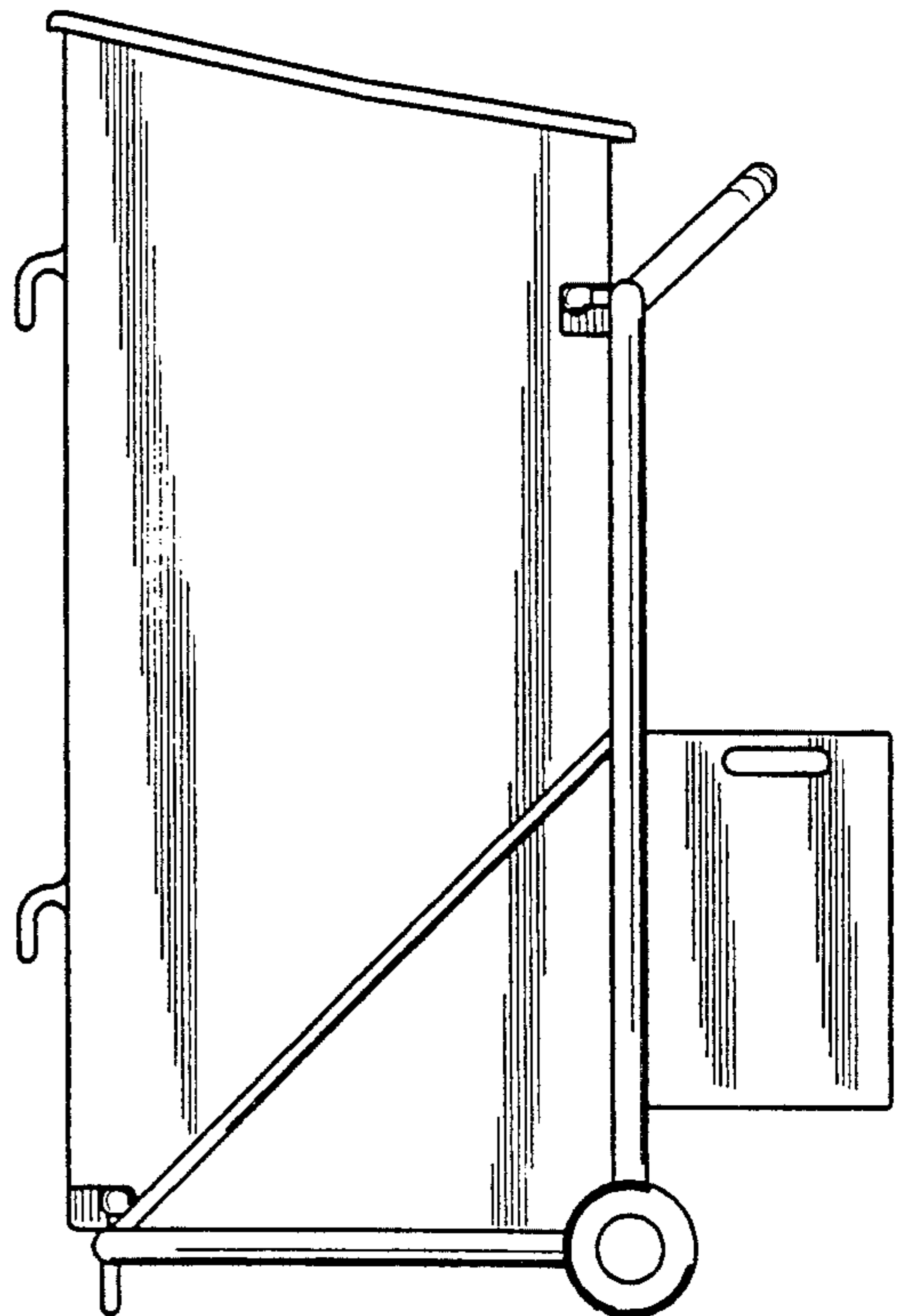

FIG. 5

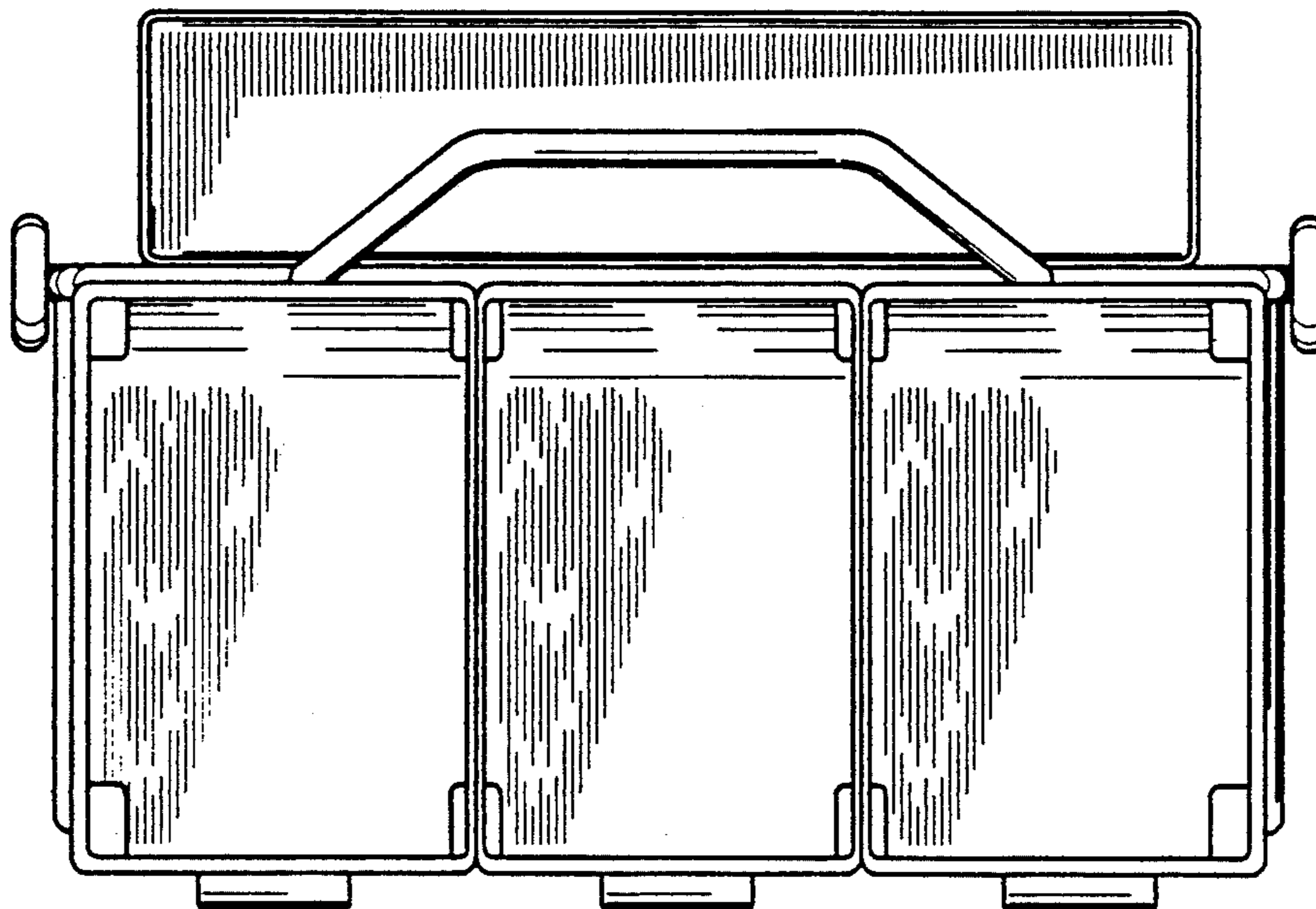

FIG. 6

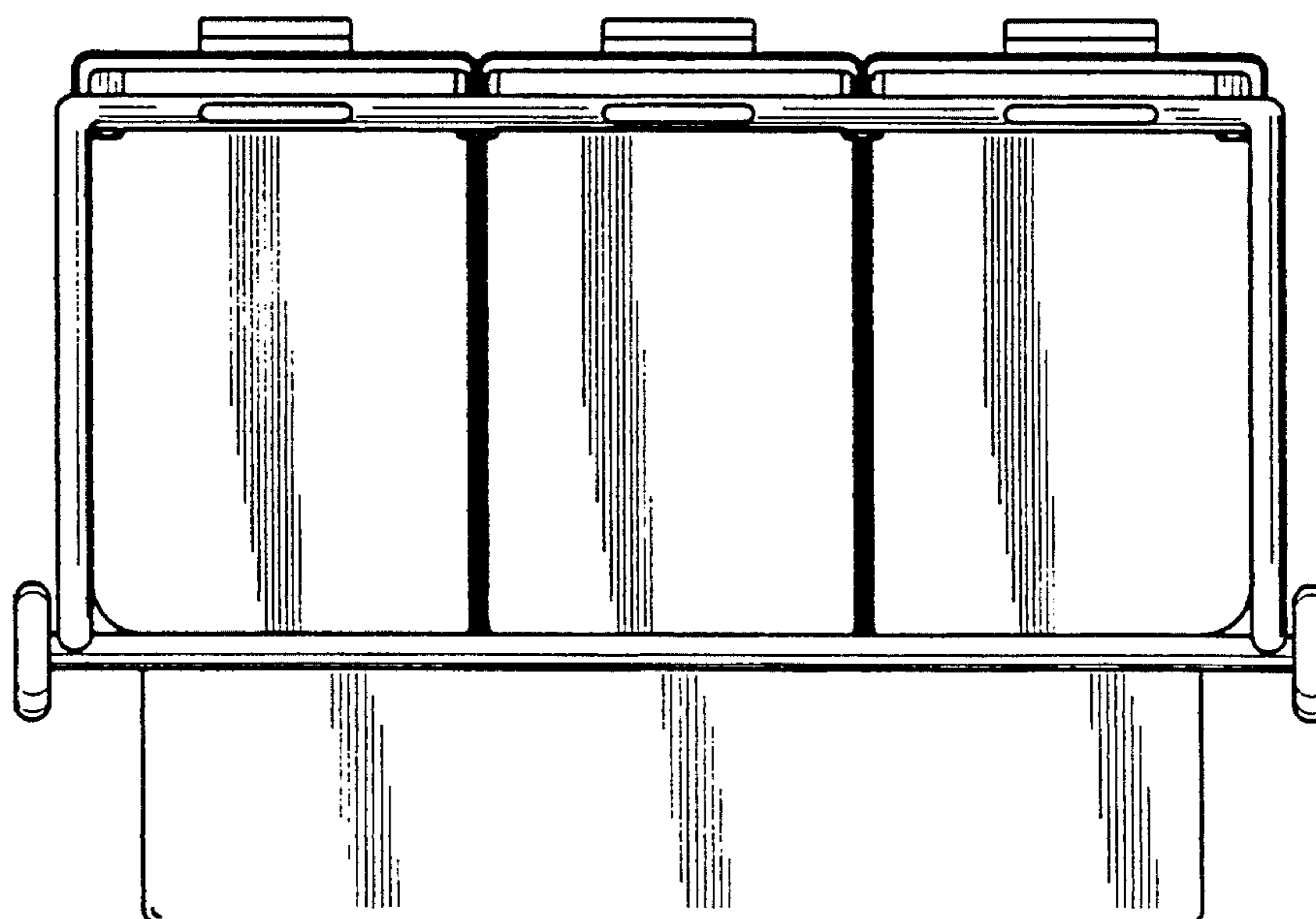



FIG. 7

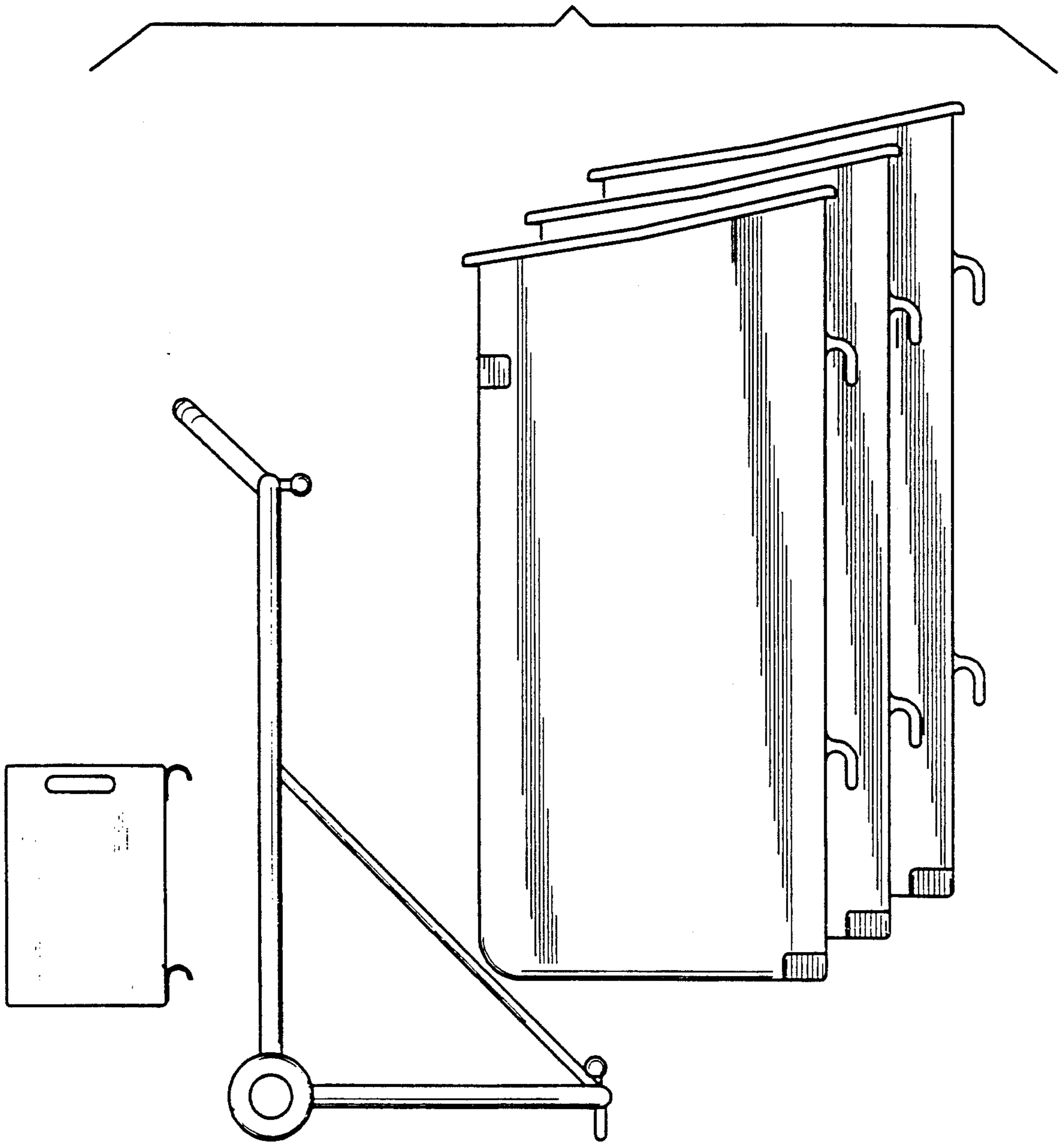

FIG. 8

