



US00D347906S

United States Patent [19] Dorick

[11] Patent Number: **Des. 347,906**

[45] Date of Patent: **** Jun. 14, 1994**

[54] **OUTDOOR ELECTRIC VOTIVE LIGHT**

5,034,868 7/1991 Stelfox et al. 362/410 X

[76] Inventor: **Thomas E. Dorick, 15 Harvard Rd.,
Fair Haven, N.J. 07704**

*Primary Examiner—Susan J. Lucas
Attorney, Agent, or Firm—Hugh E. Smith*

[**] Term: **14 Years**

[57] **CLAIM**

[21] Appl. No.: **264**

The ornamental design for a outdoor electric votive light, as shown and described.

[22] Filed: **Oct. 9, 1992**

DESCRIPTION

[52] U.S. Cl. **D26/67; D26/104**

[58] Field of Search **362/153, 153.1, 410-414,
362/431; D26/93, 102-112, 67-71**

FIG. 1 is a front elevational view of the outdoor electric votive light showing my new design;
FIG. 2 is a rear elevational view thereof;
FIG. 3 is a left side elevational view thereof;
FIG. 4 is a right side elevational view thereof;
FIG. 5 is a top plan view thereof;
FIG. 6 is a bottom plan view thereof; and,
FIG. 7 is an isometric view thereof.

[56] **References Cited**

U.S. PATENT DOCUMENTS

D. 244,875 6/1977 Baca D26/105
3,590,240 6/1971 Miller 362/412 X

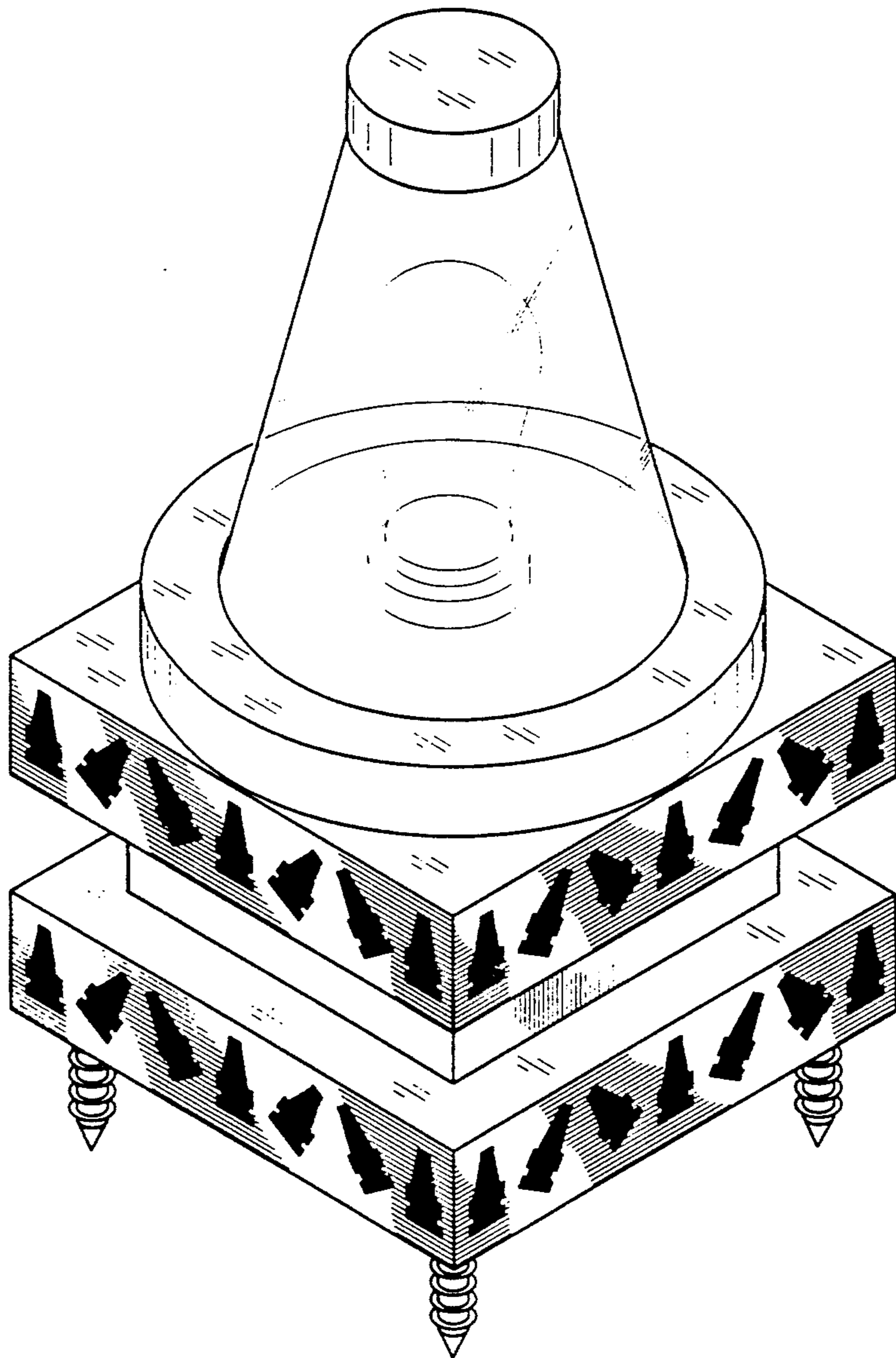

FIG. 1

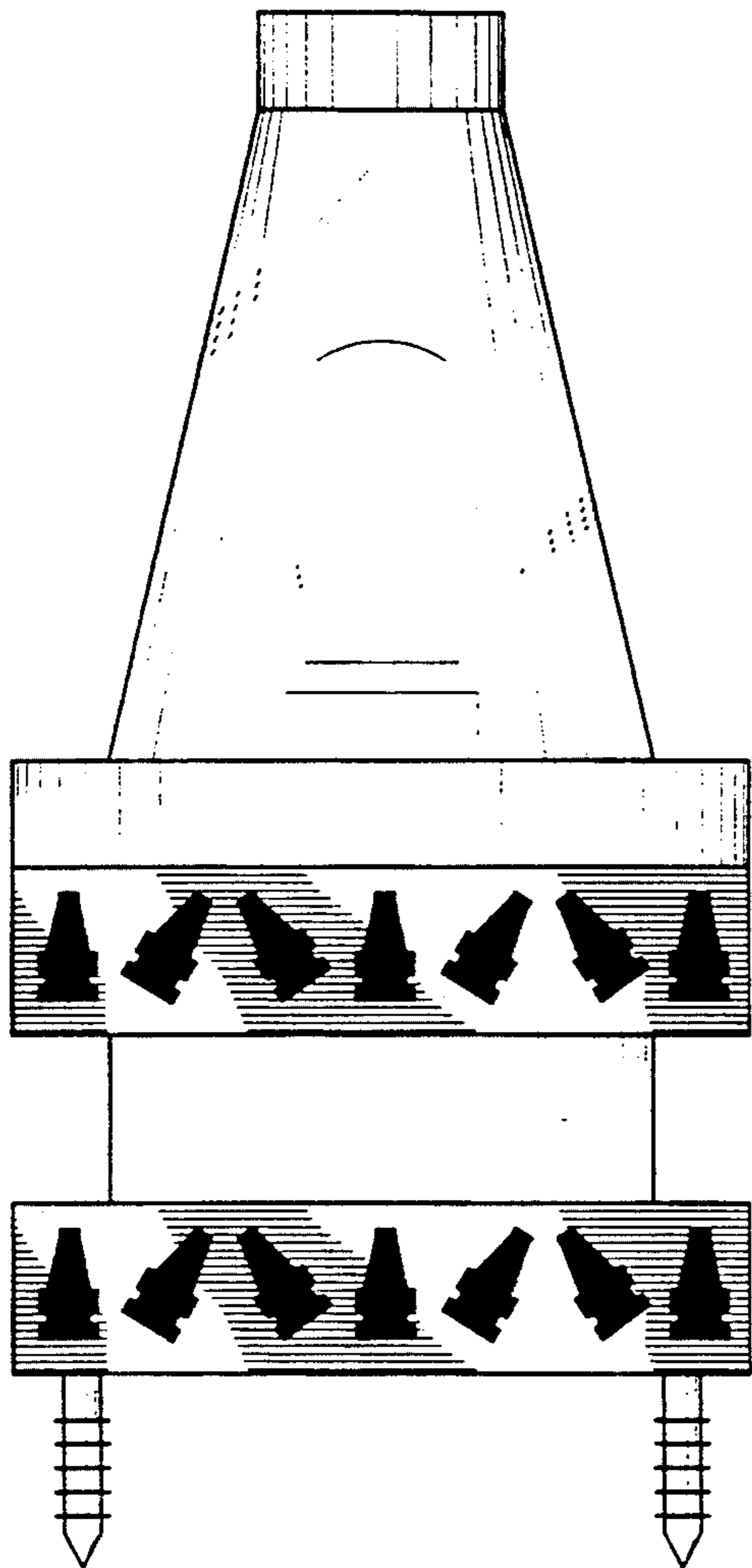

FIG. 2

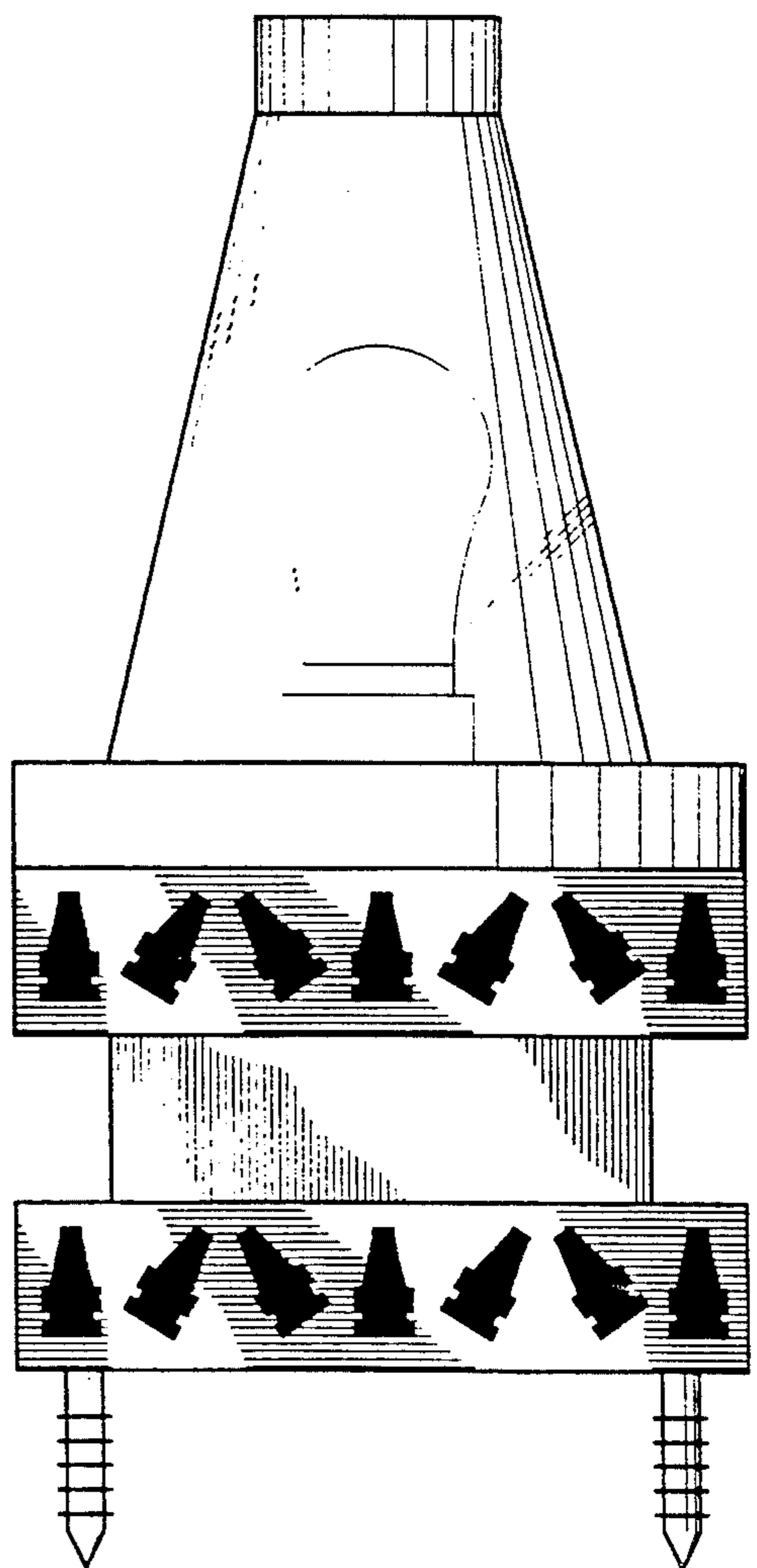

FIG. 3

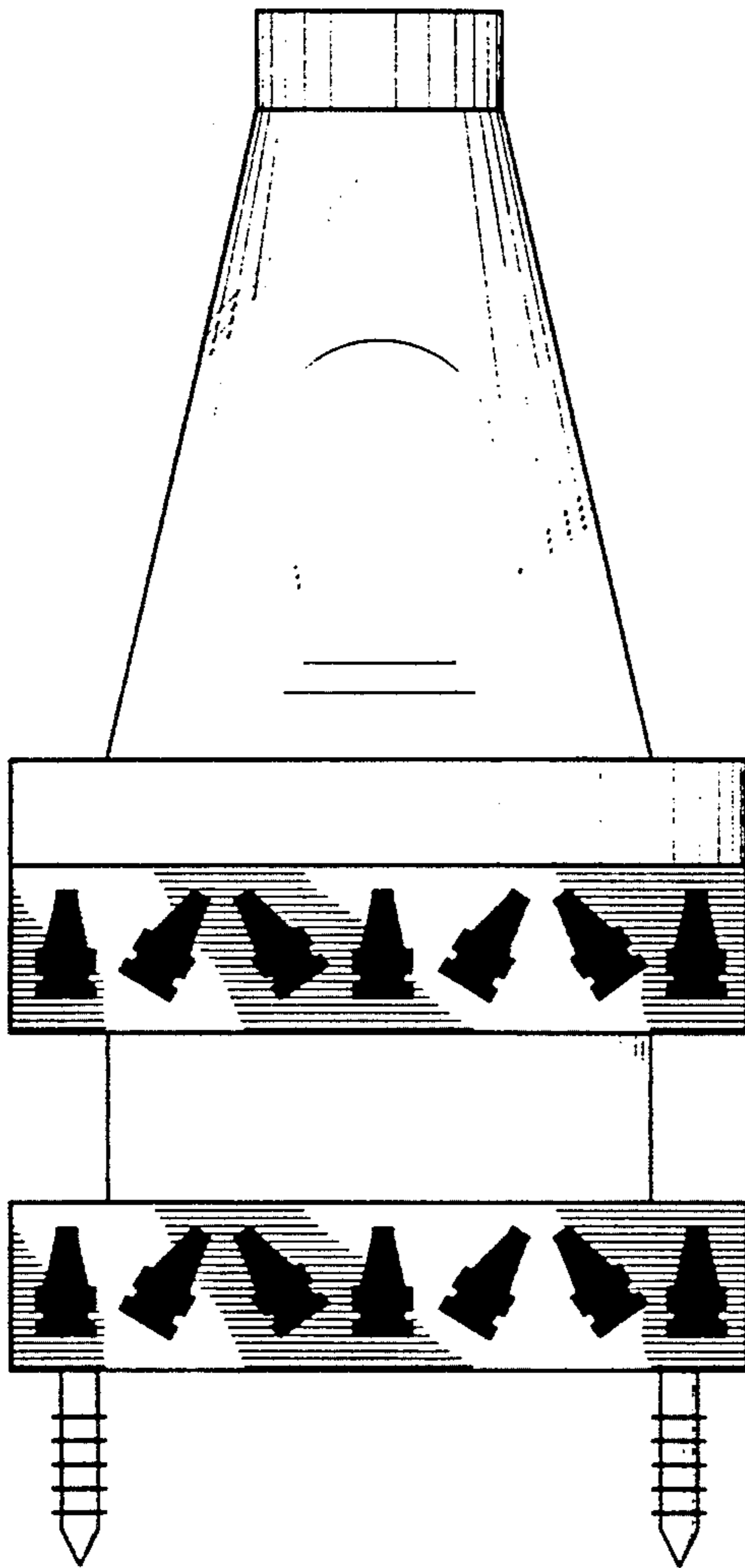

FIG. 4

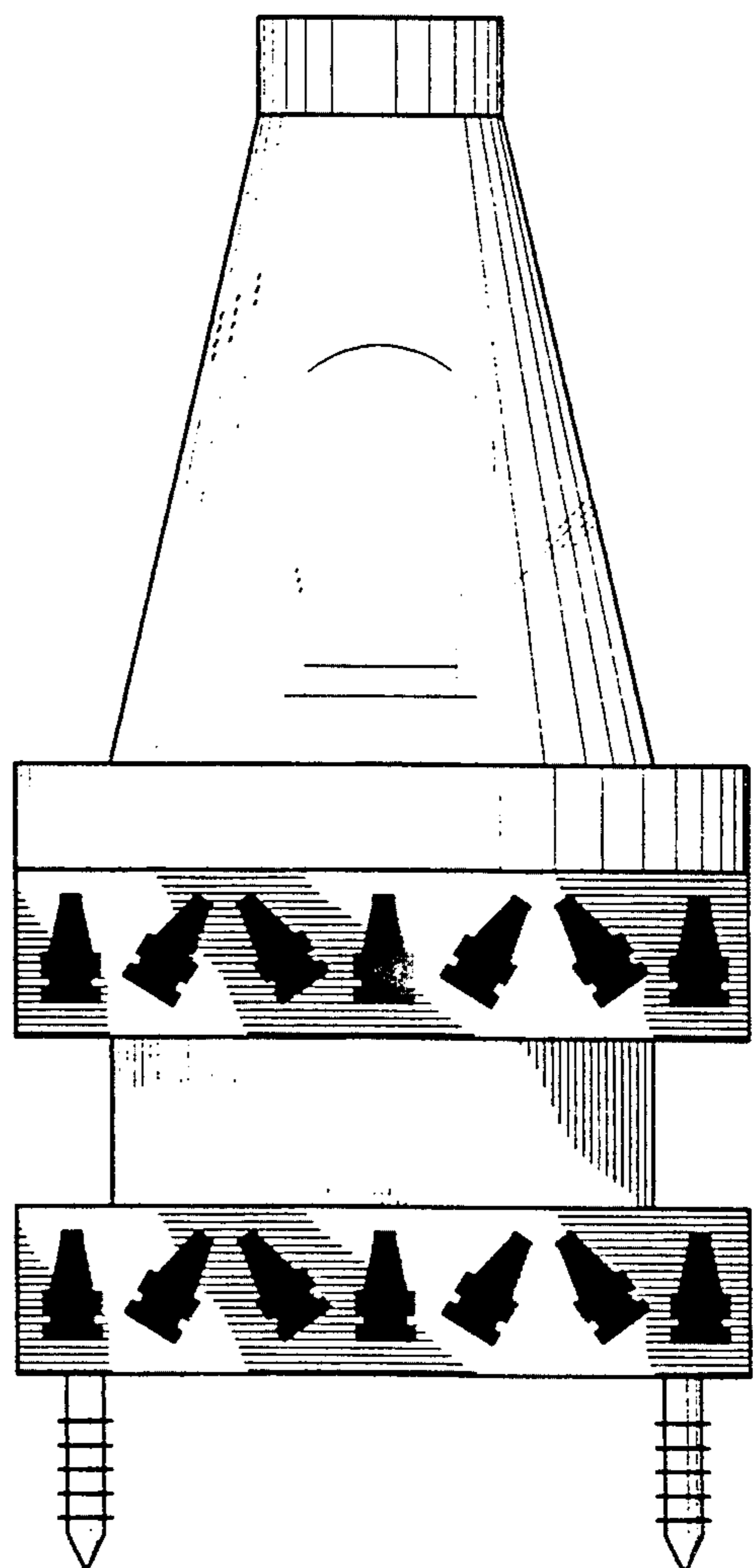

FIG. 5

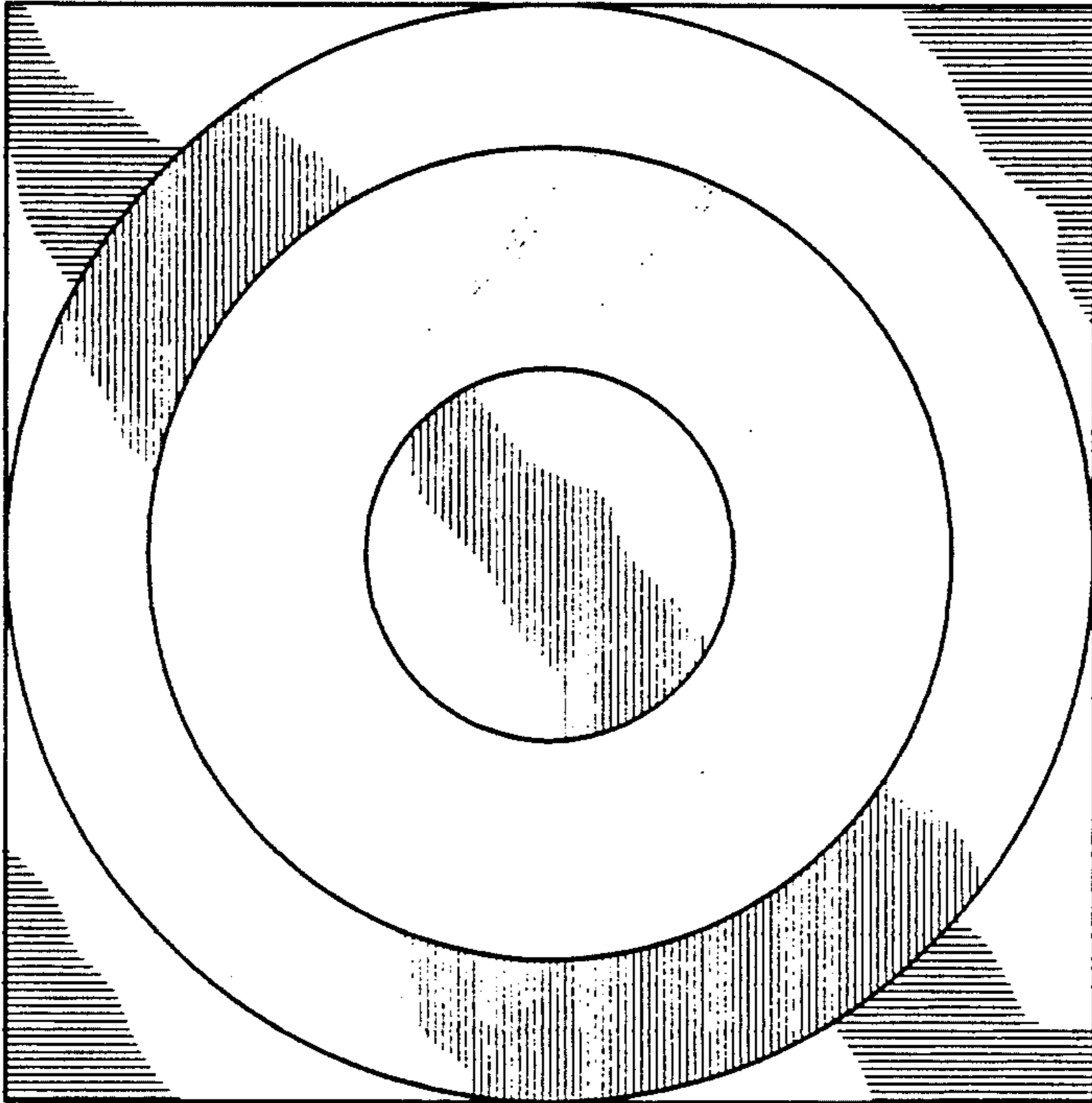

FIG. 6

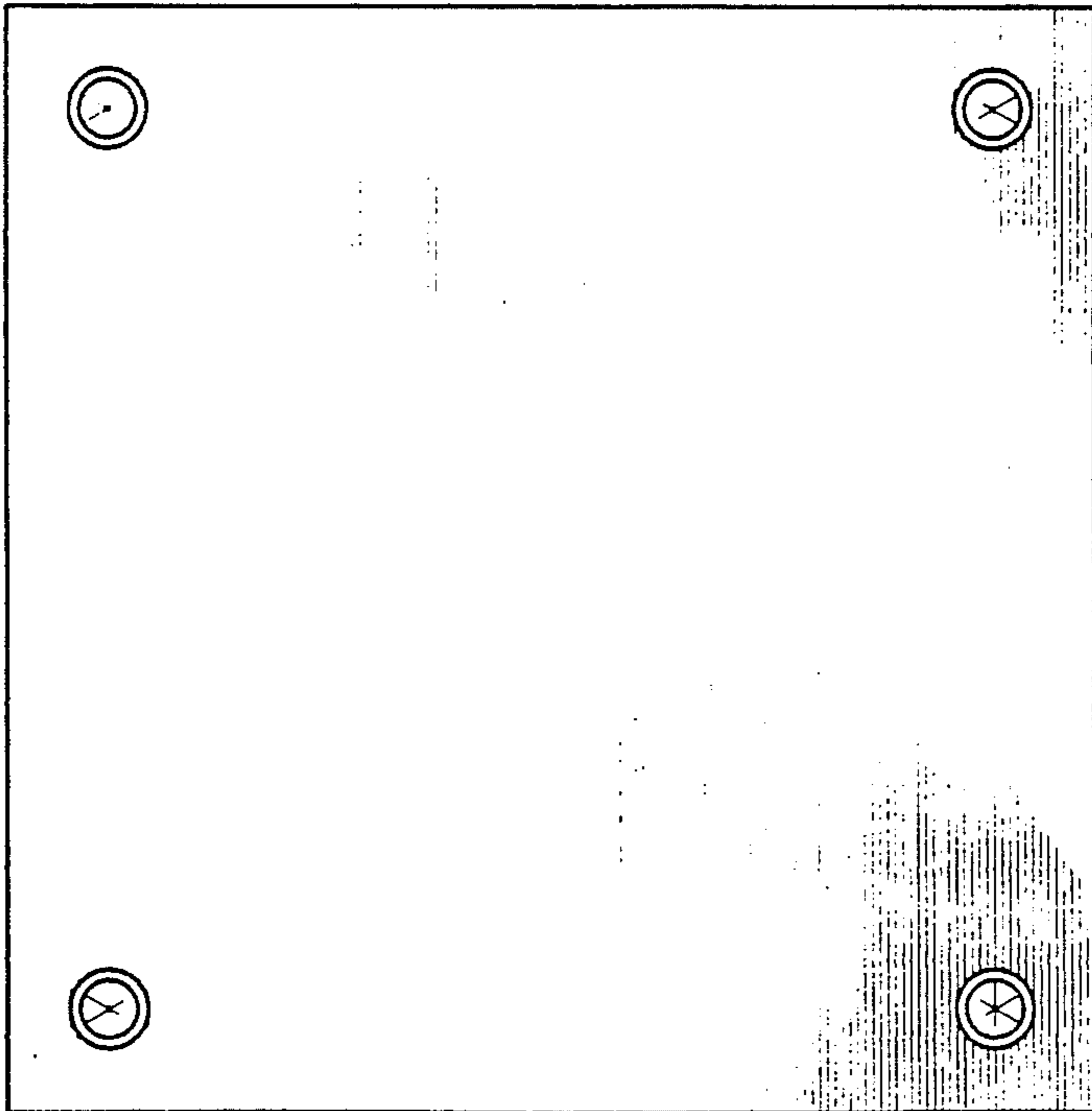

FIG. 7

