



US00D347847S

United States Patent [19]

[11] Patent Number: **Des. 347,847**

Eguchi

[45] Date of Patent: **** Jun. 14, 1994**

[54] **SEWING MACHINE**

D. 317,453	6/1991	Uguchi	D15/70
D. 321,354	11/1991	Kuroki	D15/70
D. 337,772	7/1993	Kuroki	D15/70
4,966,089	10/1990	Hanyu et al.	112/258

[75] Inventor: **Yoshiaki Eguchi, Tokyo, Japan**

[73] Assignee: **Janome Sewing Machine Co., Ltd., Tokyo, Japan**

[**] Term: **14 Years**

[21] Appl. No.: **825,859**

[22] Filed: **Jan. 21, 1992**

[30] **Foreign Application Priority Data**

Nov. 5, 1991 [JP] Japan 3-33426

[52] U.S. Cl. **D15/69**

[58] Field of Search 112/217.1-217.4,
112/258-262.1; D15/66-76

[56] **References Cited**

U.S. PATENT DOCUMENTS

D. 281,979	12/1985	Meier	D15/69
D. 285,571	9/1986	Eguchi et al.	D15/69
D. 290,368	6/1987	Eguchi	D15/69
D. 300,832	4/1989	Kuroki	D15/70

OTHER PUBLICATIONS

Evans 1991-1992 Gift Guide, ©1991 p. 229 Brother Sewing Machine, top right.

Primary Examiner—Bernard Ansher

Assistant Examiner—Sandra Morris

Attorney, Agent, or Firm—Michael J. Striker

[57] **CLAIM**

The ornamental design for a sewing machine, as shown and described.

DESCRIPTION

FIG. 1 is a front elevational plan view thereof;
 FIG. 2 is a rear elevational plan view thereof;
 FIG. 3 is a left elevational side plan view thereof;
 FIG. 4 is a right elevational side view thereof;
 FIG. 5 is a top plan view thereof;
 FIG. 6 is a bottom plan view thereof; and,
 FIG. 7 is a perspective view thereof.

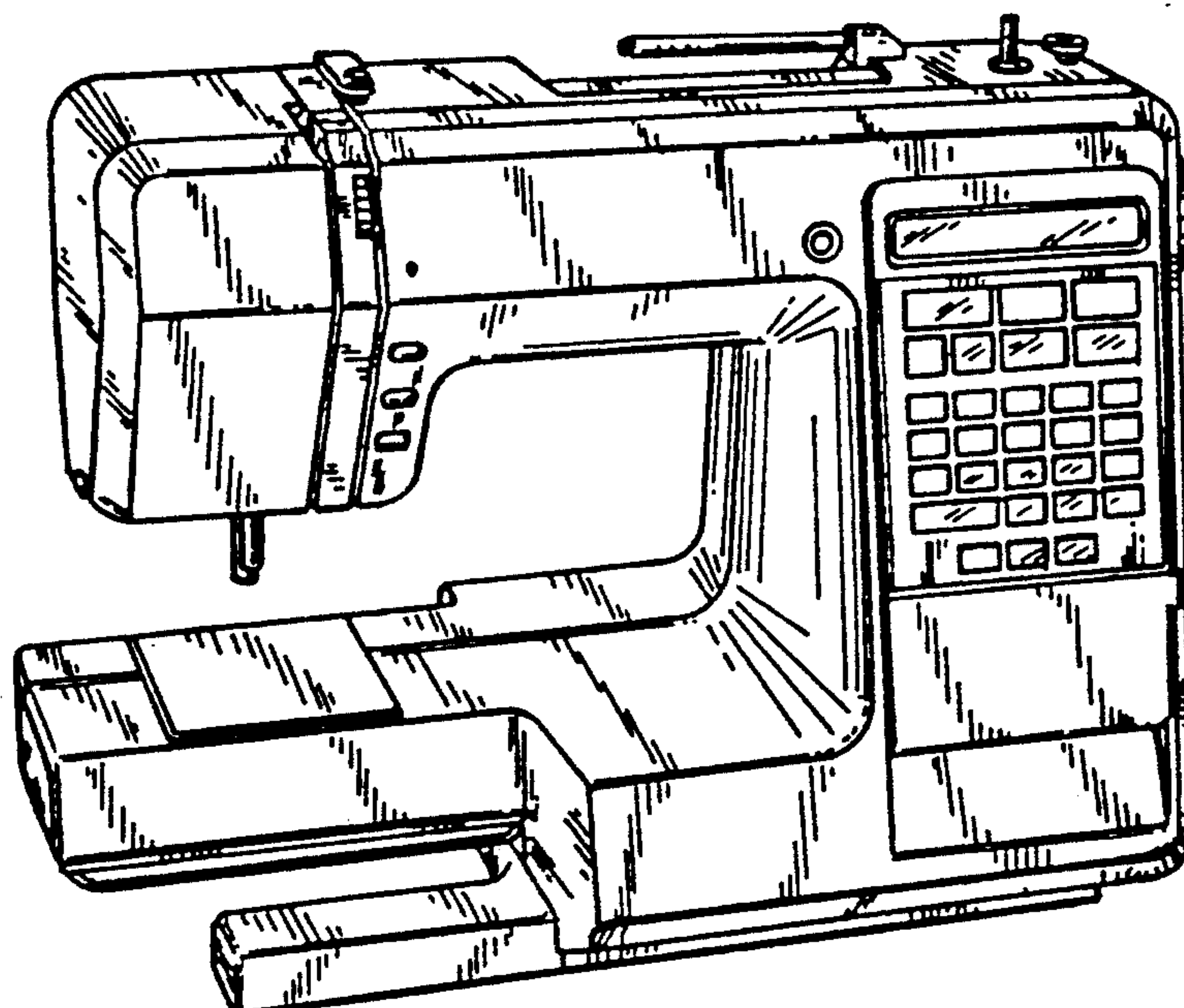

FIG. 1

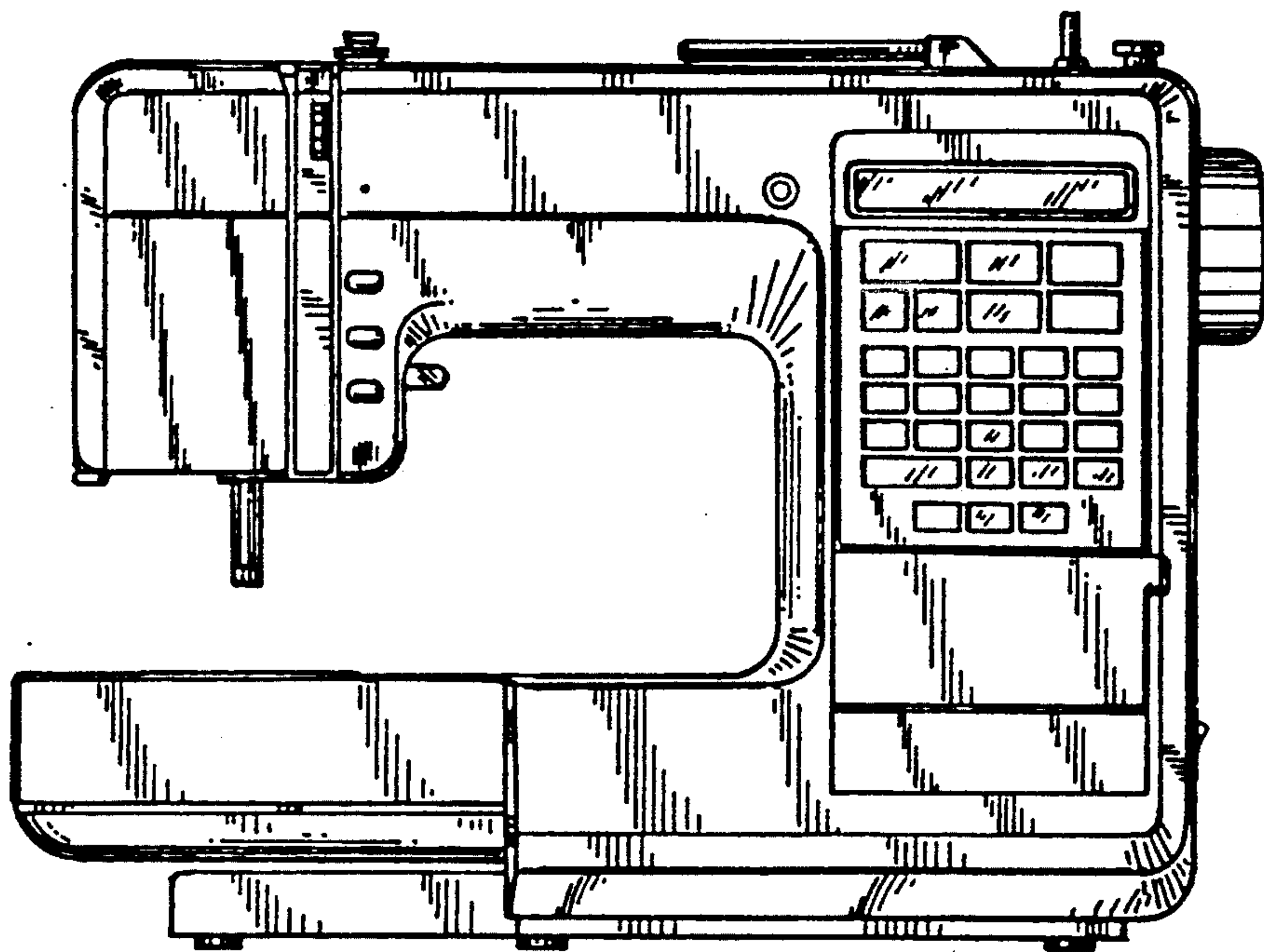

FIG. 2

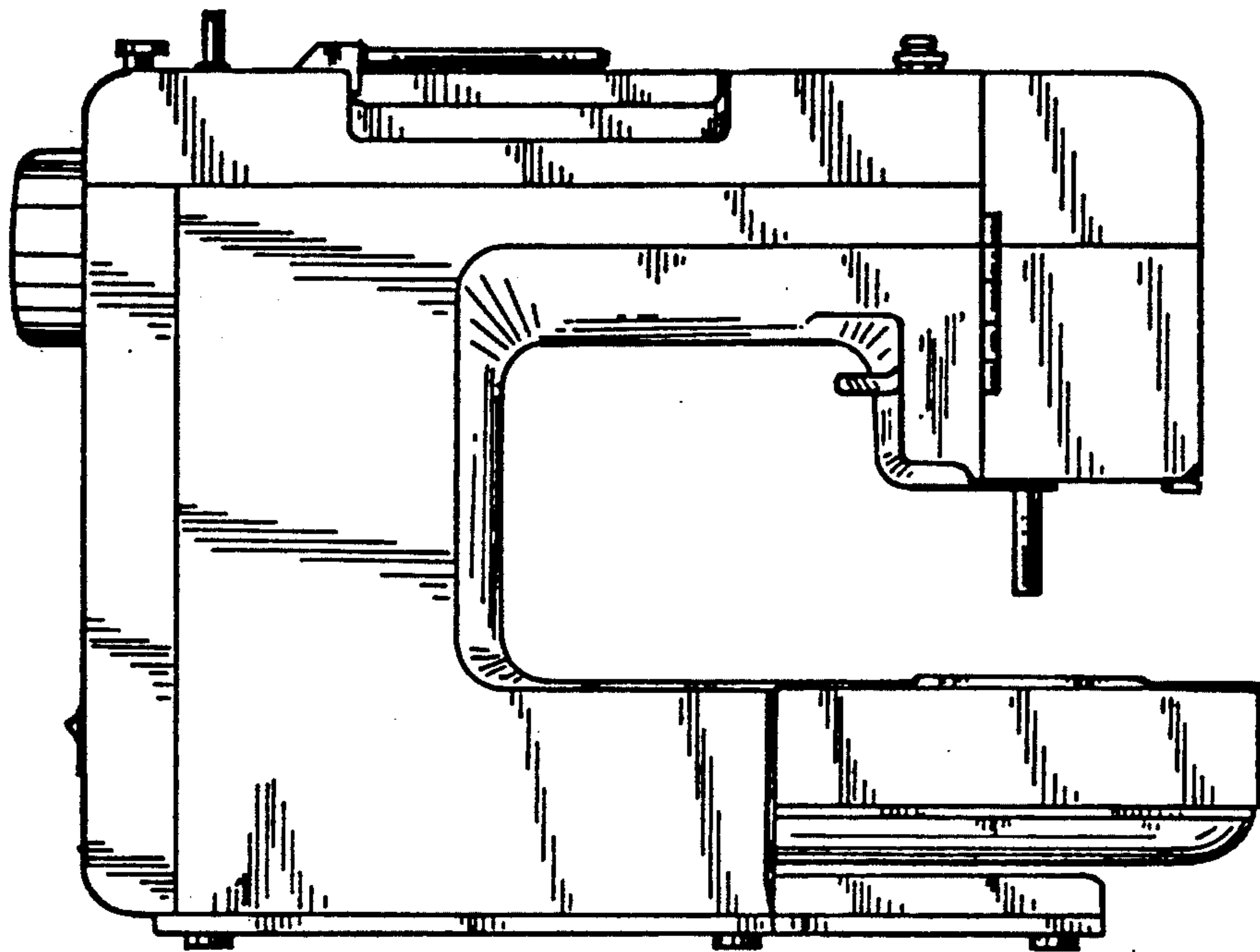

FIG. 3

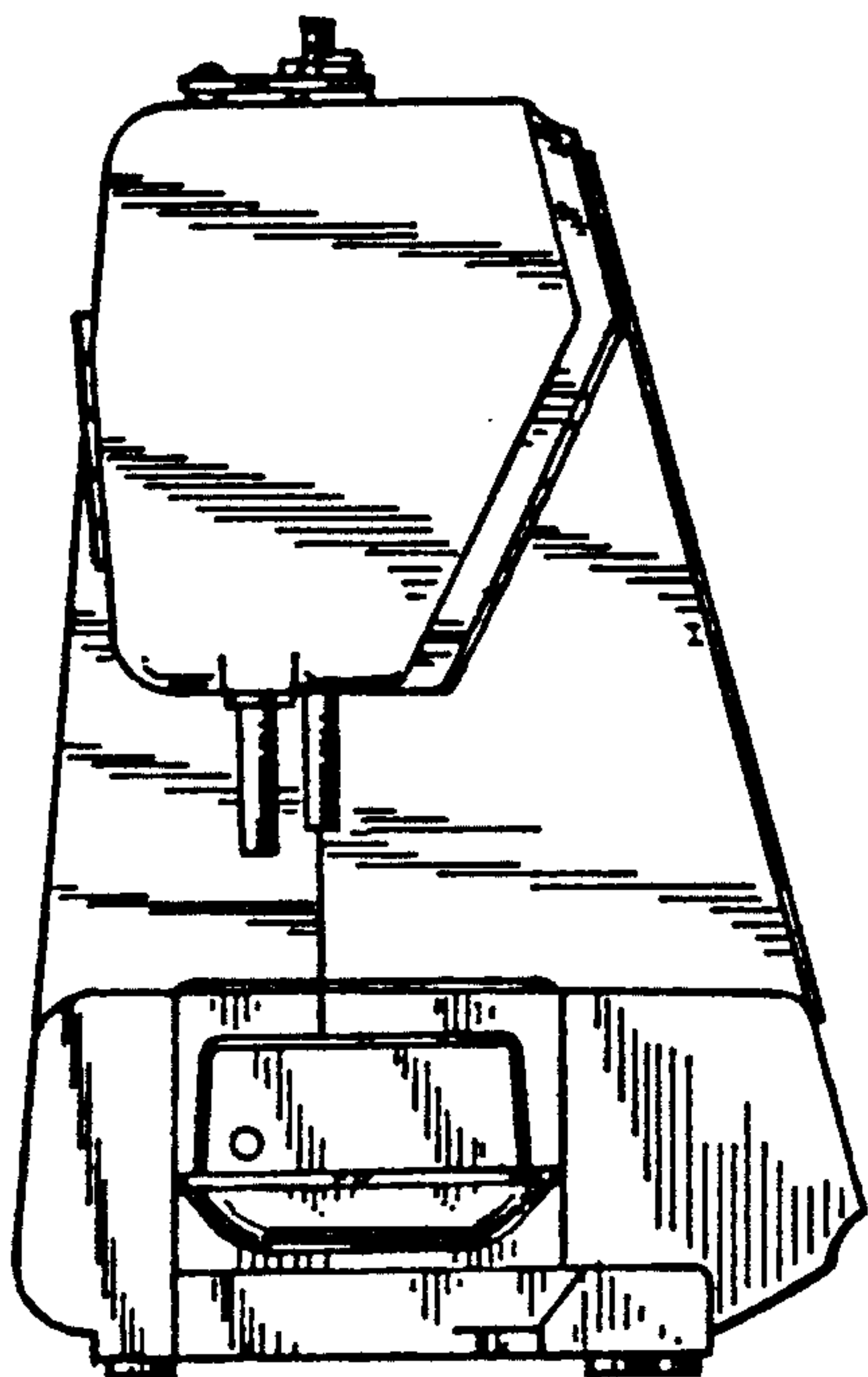
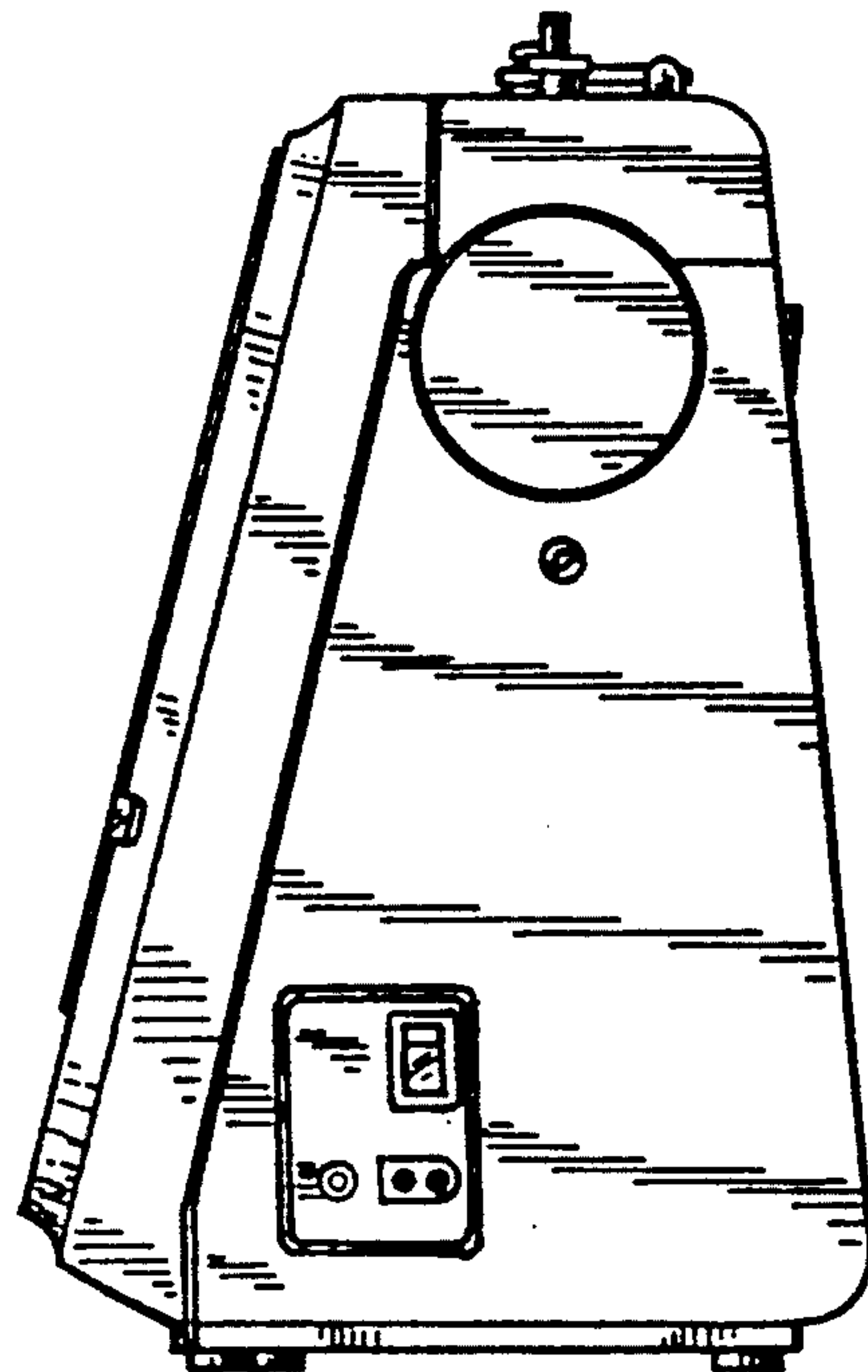
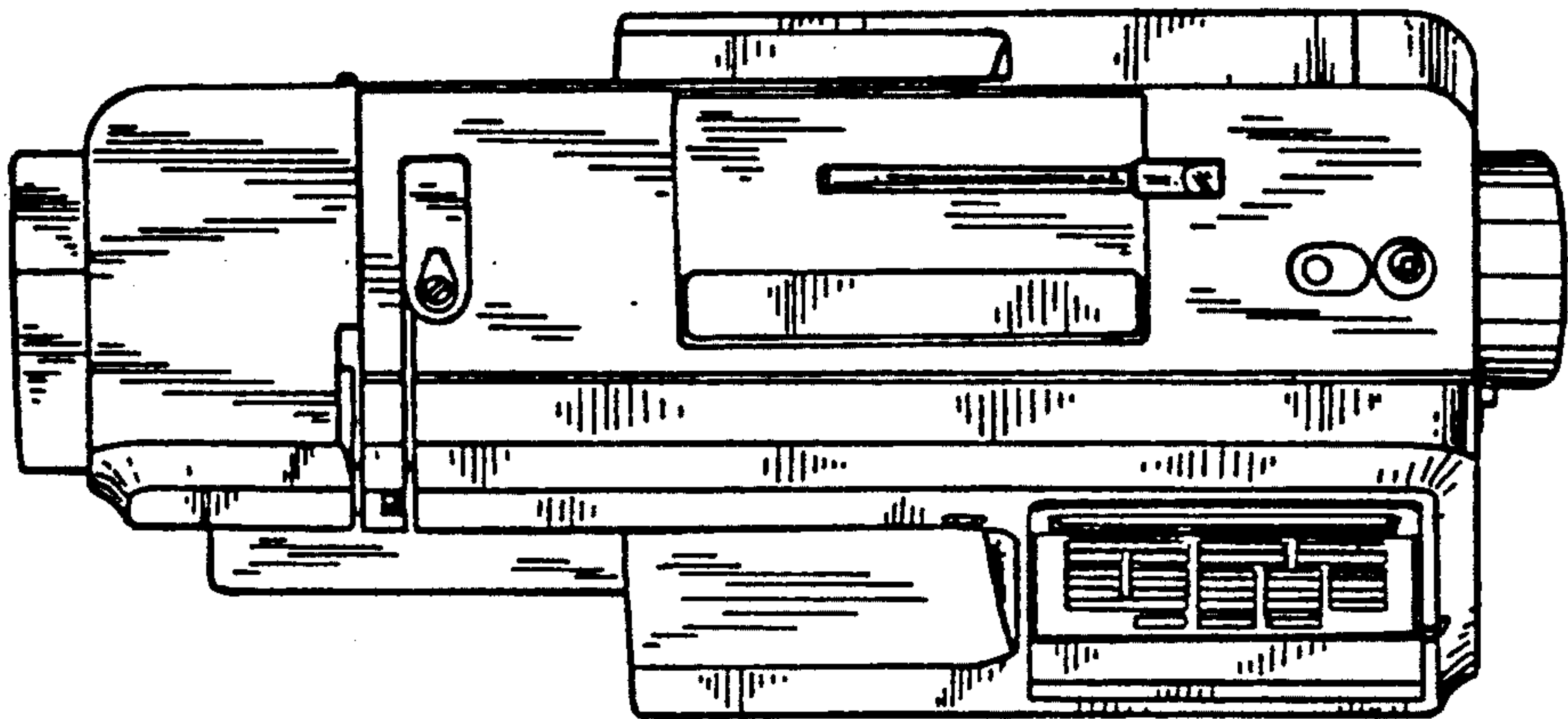

FIG. 4



FIG_5



FIG_6

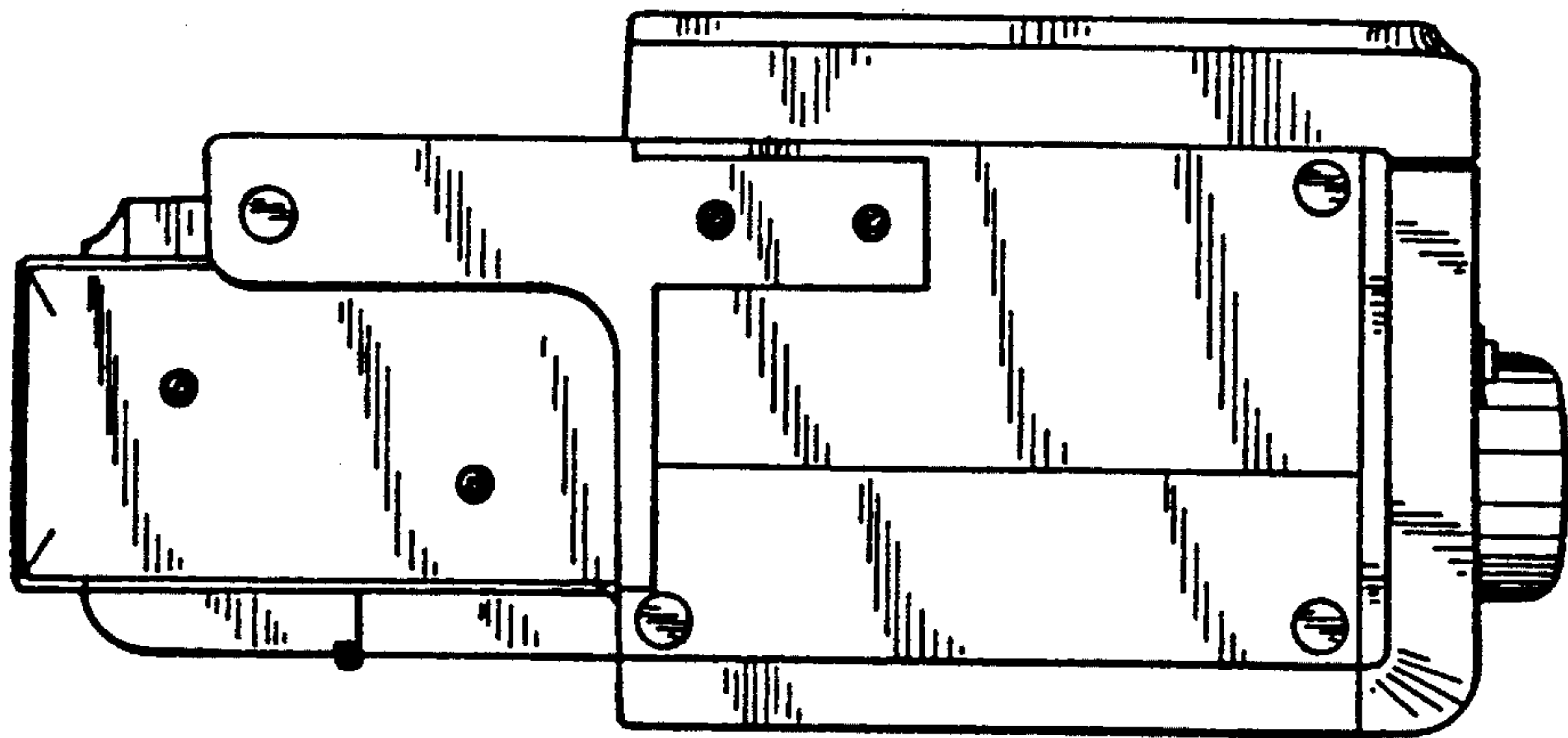

FIG. 7

