



US00D347802S

United States Patent [19]

[11] Patent Number: Des. 347,802

Kielbasa

[45] Date of Patent: ** Jun. 14, 1994

- [54] CHRISTMAS ORNAMENTAL DISPLAY
- [75] Inventor: Karen T. Kielbasa, Hong Kong, Hong Kong
- [73] Assignee: Mr. Christmas, Inc., New York, N.Y.
- [**] Term: 14 Years
- [21] Appl. No.: 4,833
- [22] Filed: Dec. 7, 1992
- [52] U.S. Cl. D11/121; D11/125; D11/157; D11/159; D20/30
- [58] Field of Search 362/249, 252, 806, 808; 40/411, 414, 421, 423; D11/117, 121, 125, 133, 135, 157, 159; D26/25; D21/59; D20/30

- [56] **References Cited**
- U.S. PATENT DOCUMENTS**
- D. 65,741 10/1924 Hartman D21/64
- D. 136,448 10/1943 Kimmich D11/165
- D. 215,304 9/1969 Kadmon et al. D26/25
- 674,970 5/1901 Kennedy 40/411 X
- 2,107,641 2/1938 Malcomson D11/125 X
- 2,307,296 1/1943 Peyton 40/411 X
- 5,067,061 11/1991 Prichett 362/806 X

Primary Examiner—Bernard Ansher
 Assistant Examiner—Dominic Simone

[57] **CLAIM**

The ornamental design for a christmas ornamental display, as shown and described.

DESCRIPTION

FIG. 1 is a perspective view of an ornamental display showing my new design;
 FIG. 2 is a front elevational view of the wagon of the display of FIG. 1;

FIG. 3 is a left-side elevational view of the wagon depicted in FIG. 2;
 FIG. 4 is a right-side elevational view of the wagon depicted in FIG. 2;
 FIG. 5 is a top plan view of the wagon depicted in FIG. 2;
 FIG. 6 is a bottom plan view of the wagon depicted in FIG. 2;
 FIG. 7 is a front view of the upper left carousel horse and housing depicted in FIG. 1;
 FIG. 8 is a back view of FIG. 7;
 FIG. 9 is a bottom view of FIG. 7;
 FIG. 10 is a top view of FIG. 7;
 FIG. 11 is a right side view of FIG. 7;
 FIG. 12 is a left side view of FIG. 7;
 FIG. 13 is a front view of the upper right carousel horse and housing depicted in FIG. 1;
 FIG. 14 is a back view of FIG. 13;
 FIG. 15 is a bottom view of FIG. 13;
 FIG. 16 is a top view of FIG. 13;
 FIG. 17 is a right side view of FIG. 13;
 FIG. 18 is a left side view of FIG. 13;
 FIG. 19 is a front view of the lower left-most carousel horse and housing depicted in FIG. 1;
 FIG. 20 is a back view of FIG. 19;
 FIG. 21 is a bottom view of FIG. 19;
 FIG. 22 is a top view of FIG. 19;
 FIG. 23 is a right side view of FIG. 19;
 FIG. 24 is a left side view of FIG. 19;
 FIG. 25 is a front view of the lower, second from the left carousel horse and housing depicted in FIG. 1;
 FIG. 26 is a back view of FIG. 25;
 FIG. 27 is a bottom view of FIG. 25;
 FIG. 28 is a top view of FIG. 25;
 FIG. 29 is a right side view of FIG. 25; and,
 FIG. 30 is a left side view of FIG. 25.

The elements of the claimed design are shown separately for clarity of illustration.

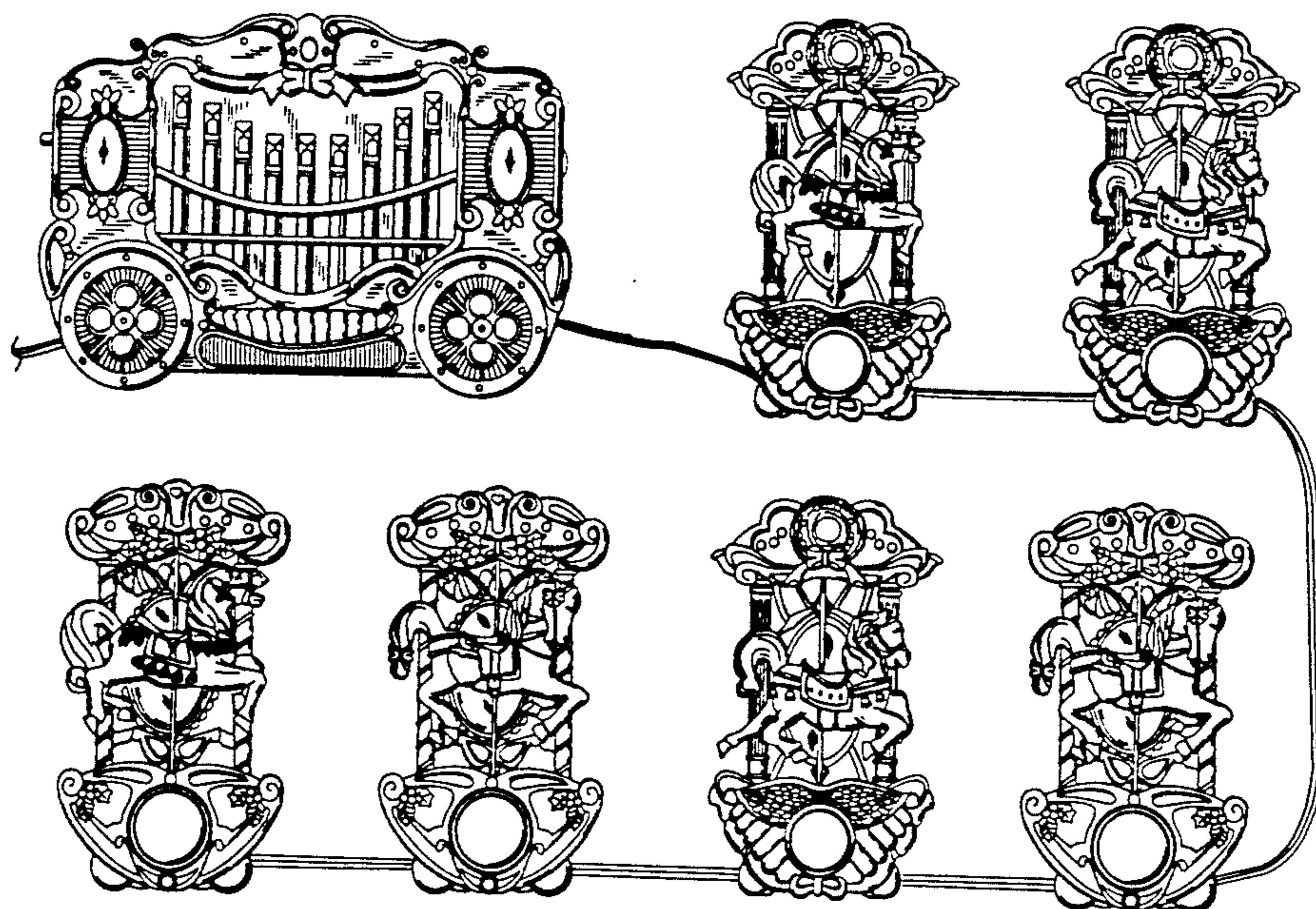

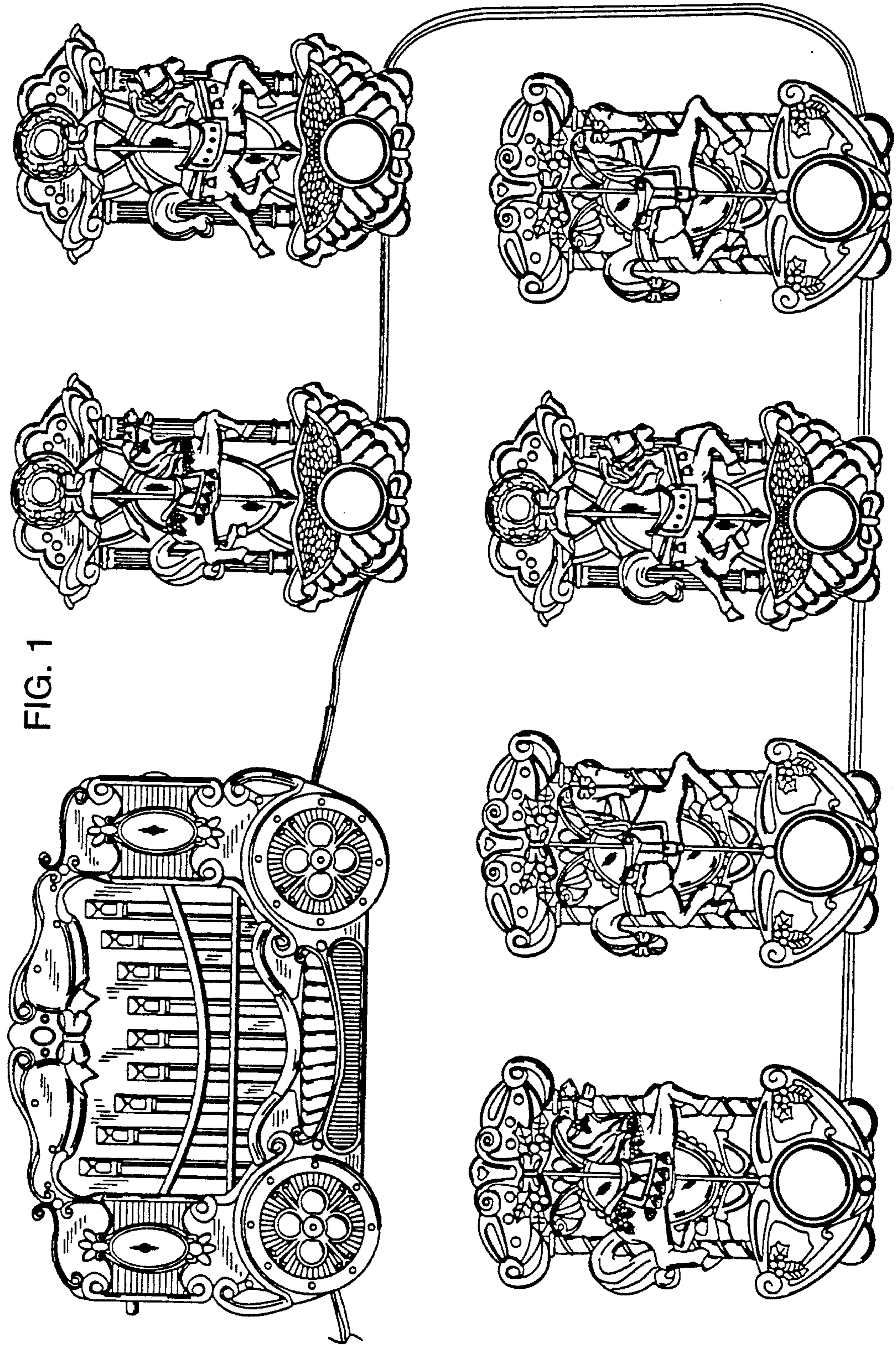

FIG. 1

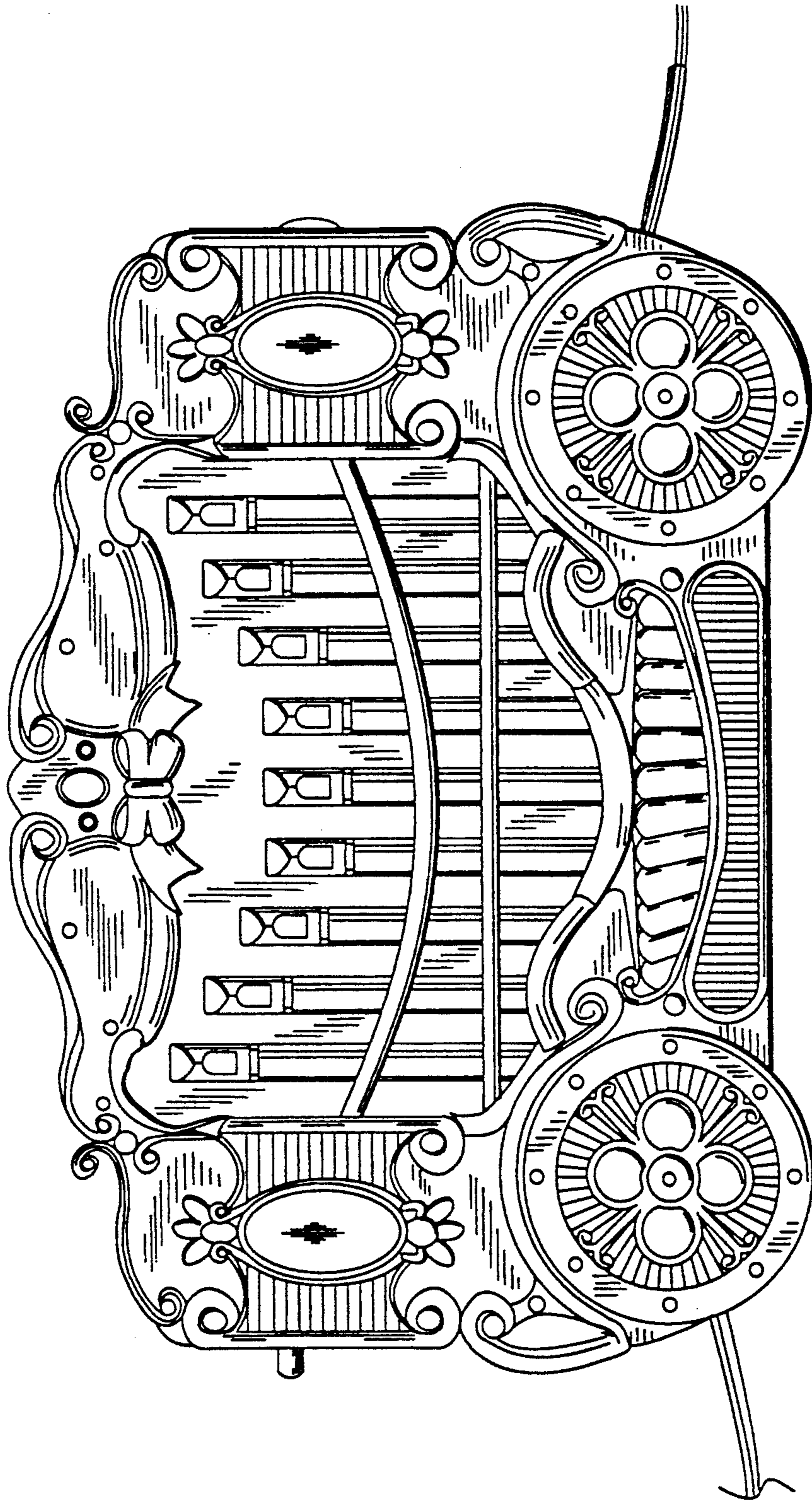

FIG. 2

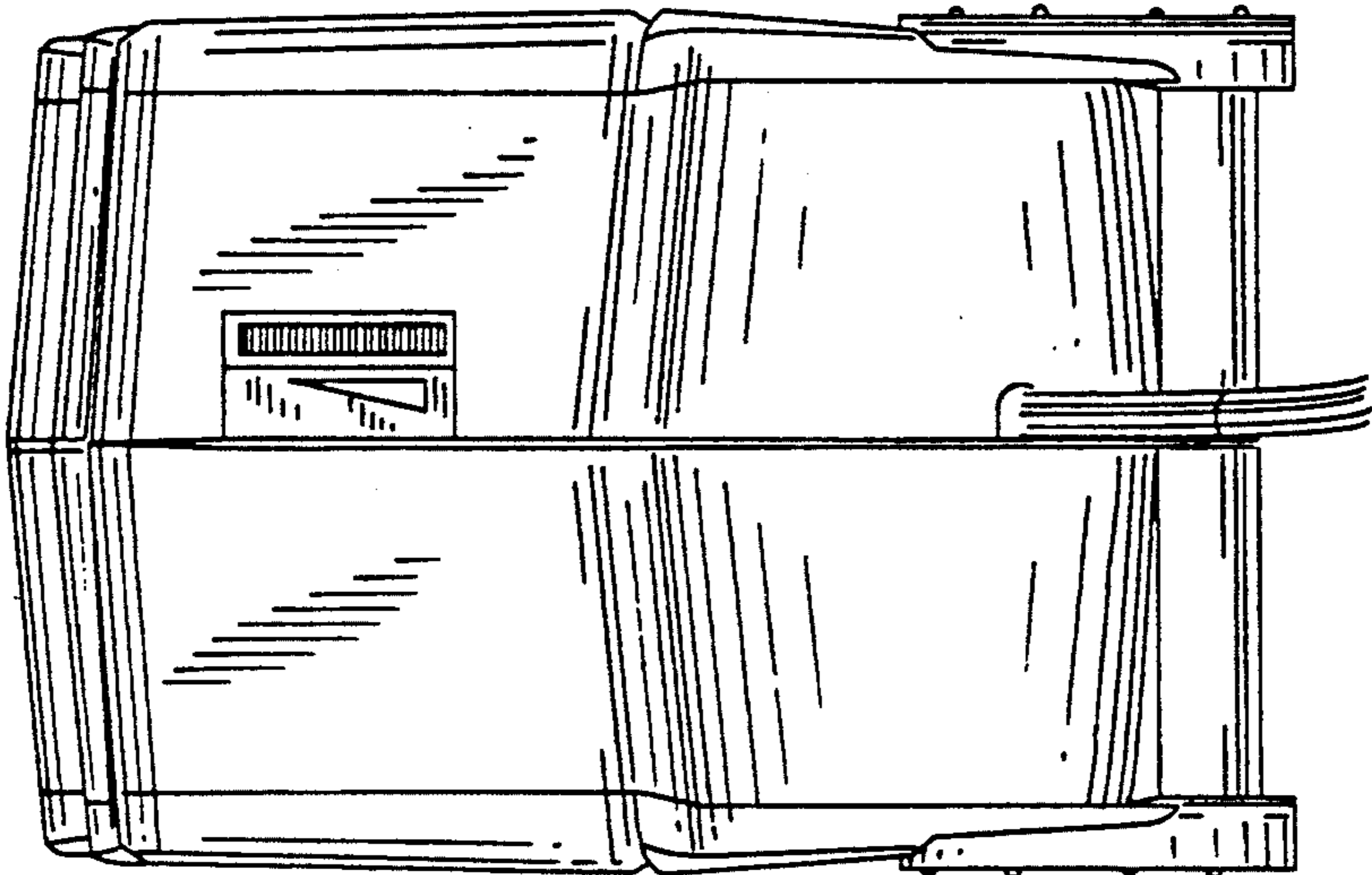

FIG. 4

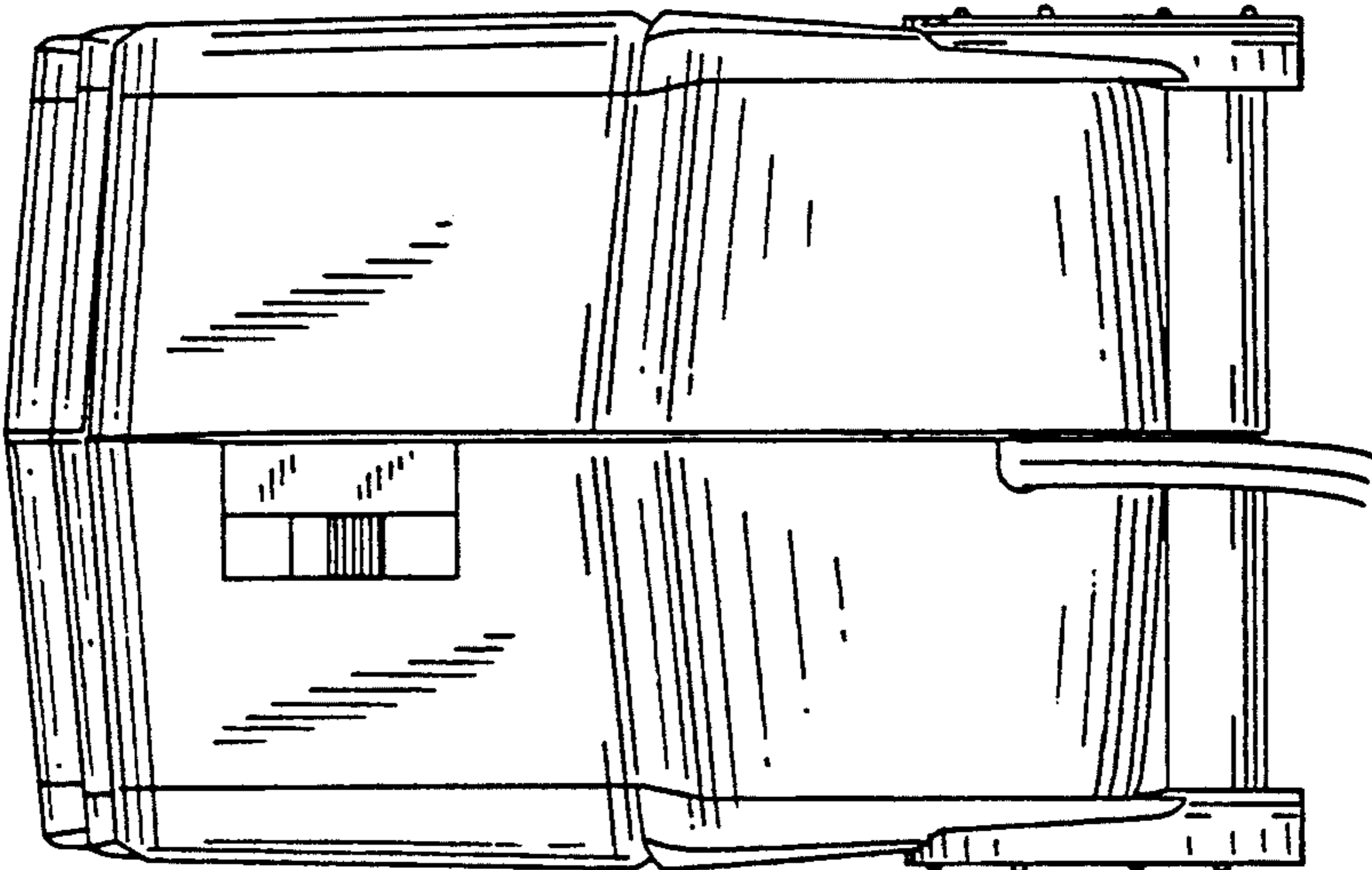

FIG. 3

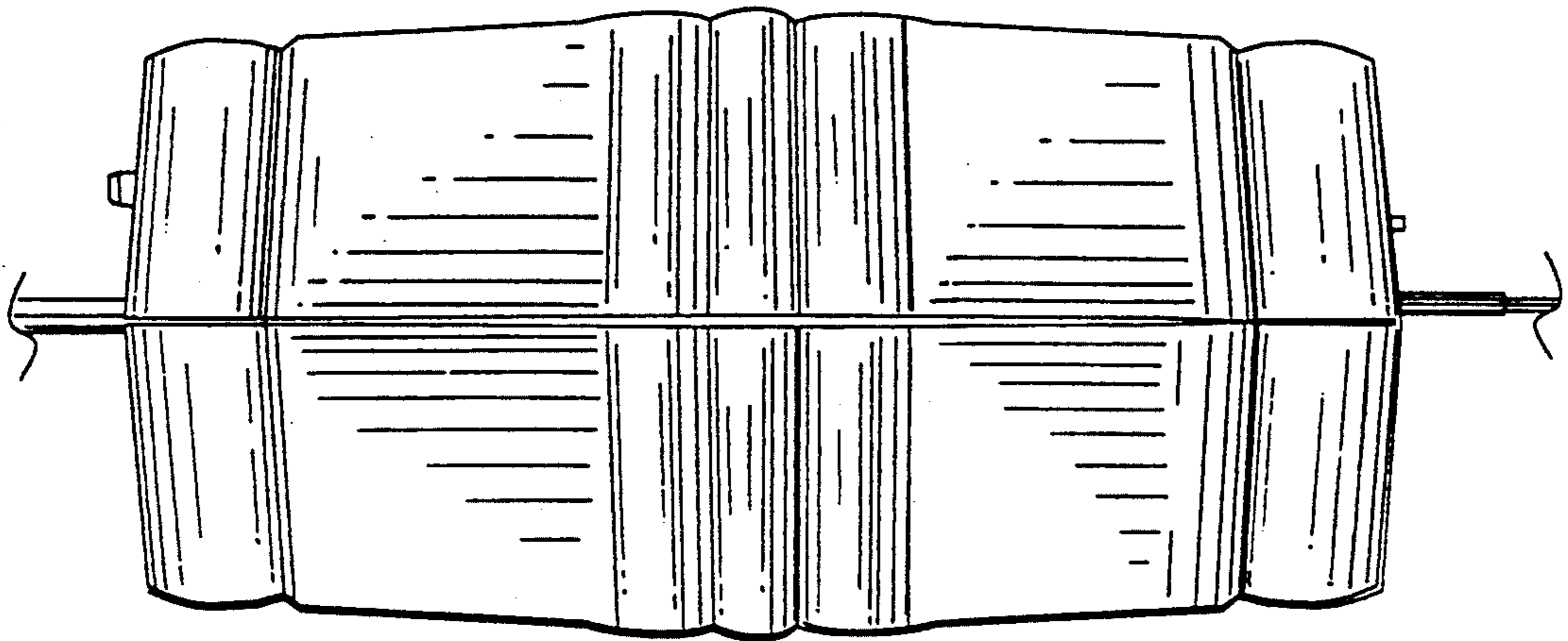

FIG. 5

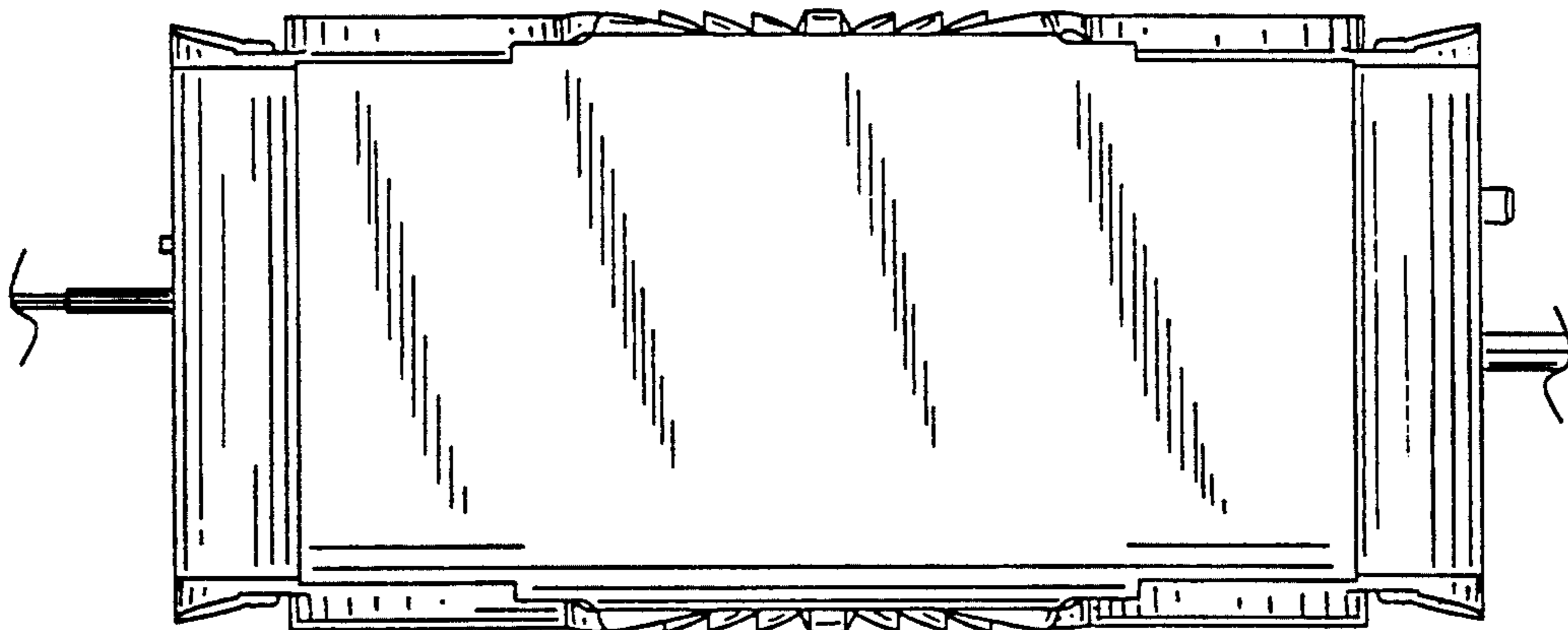

FIG. 6

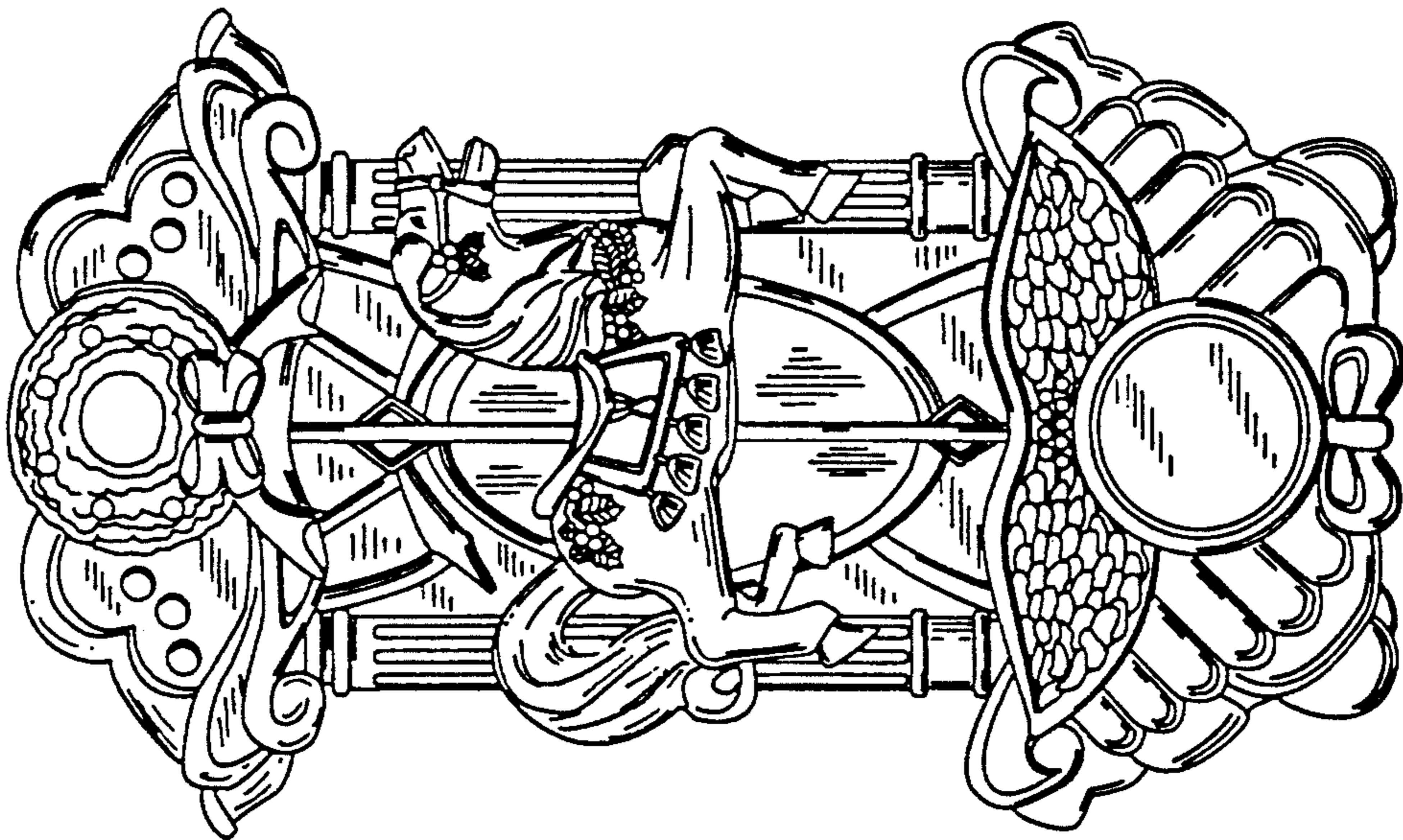

FIG. 7

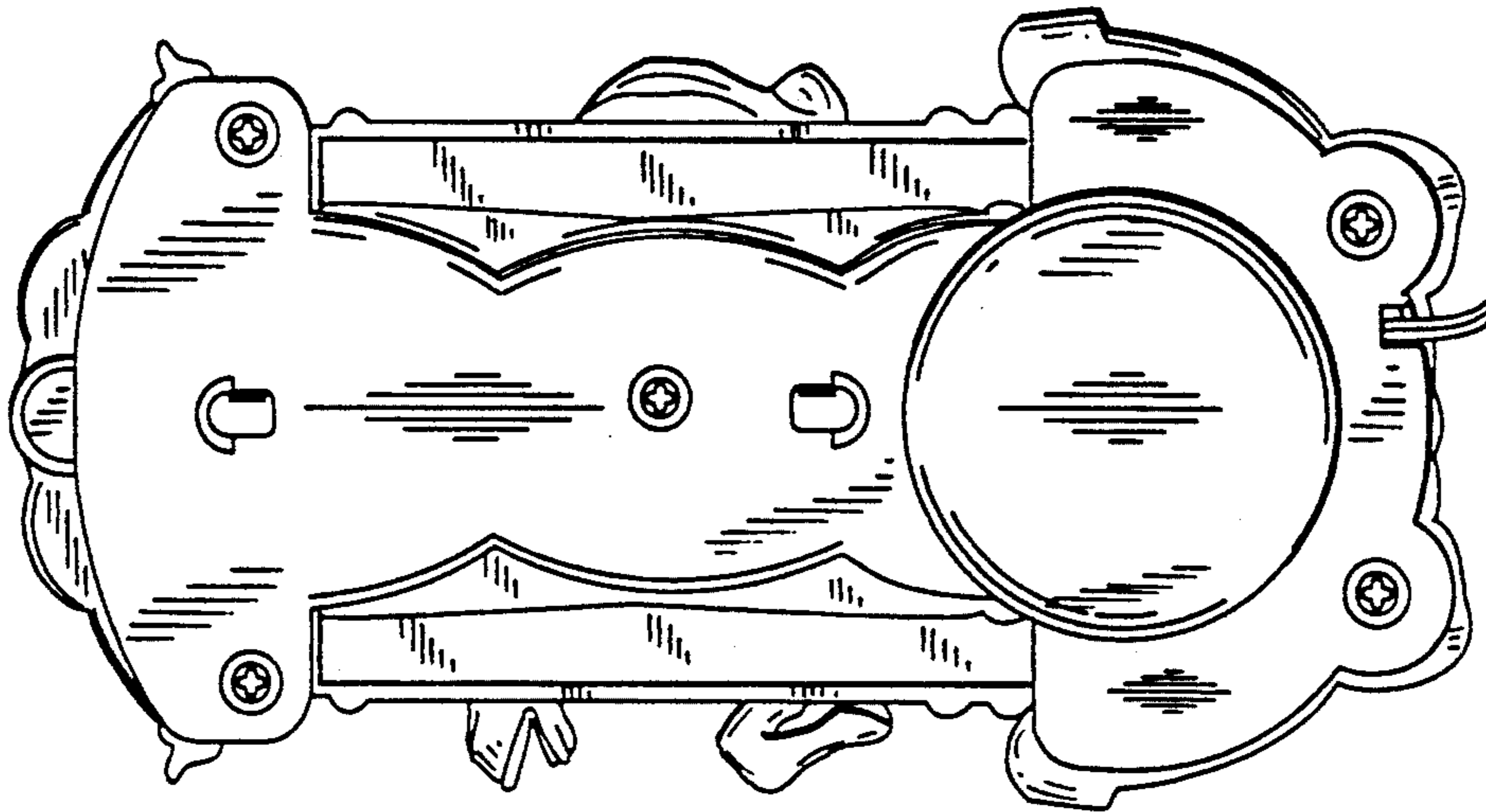

FIG. 8

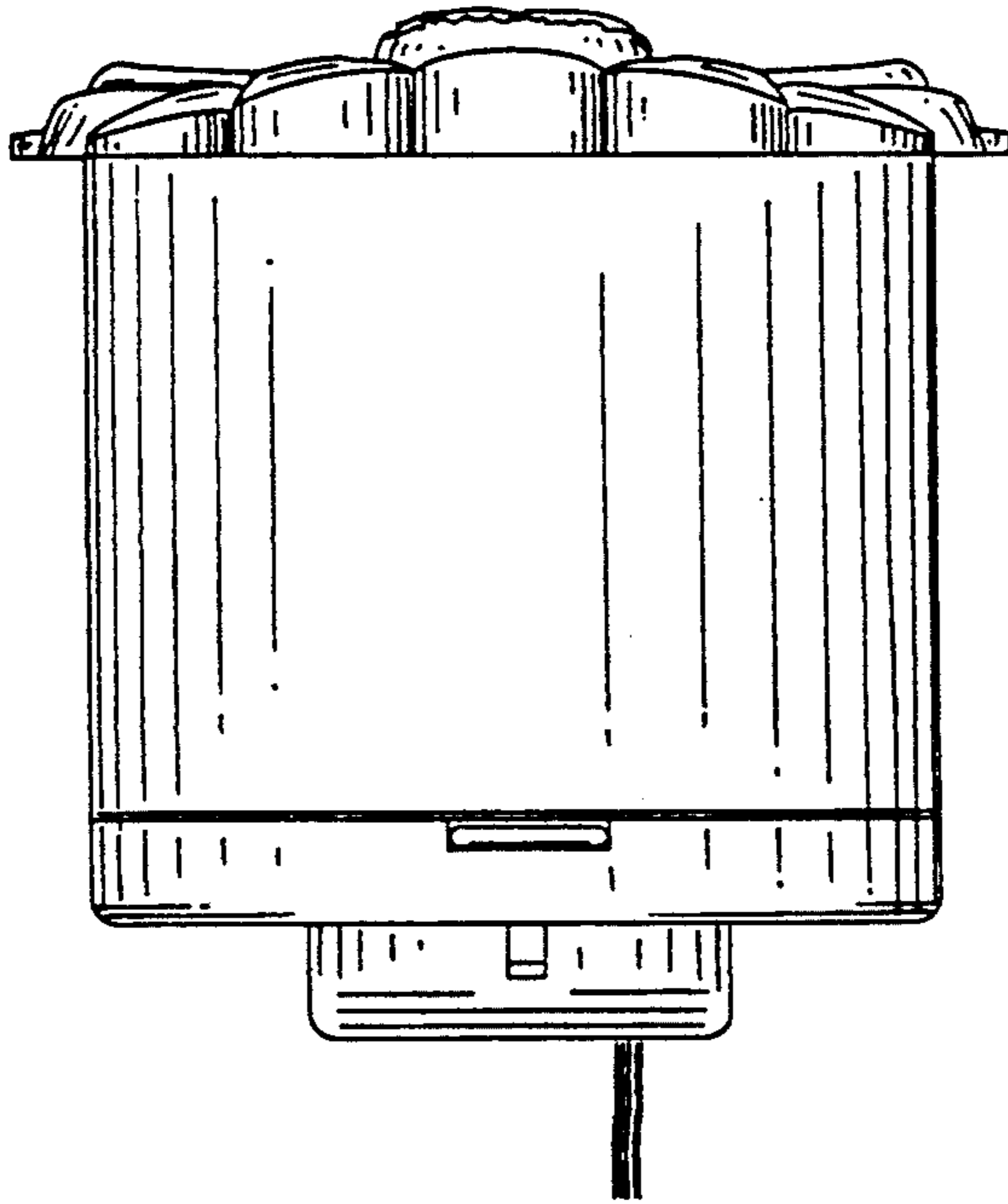

FIG. 9

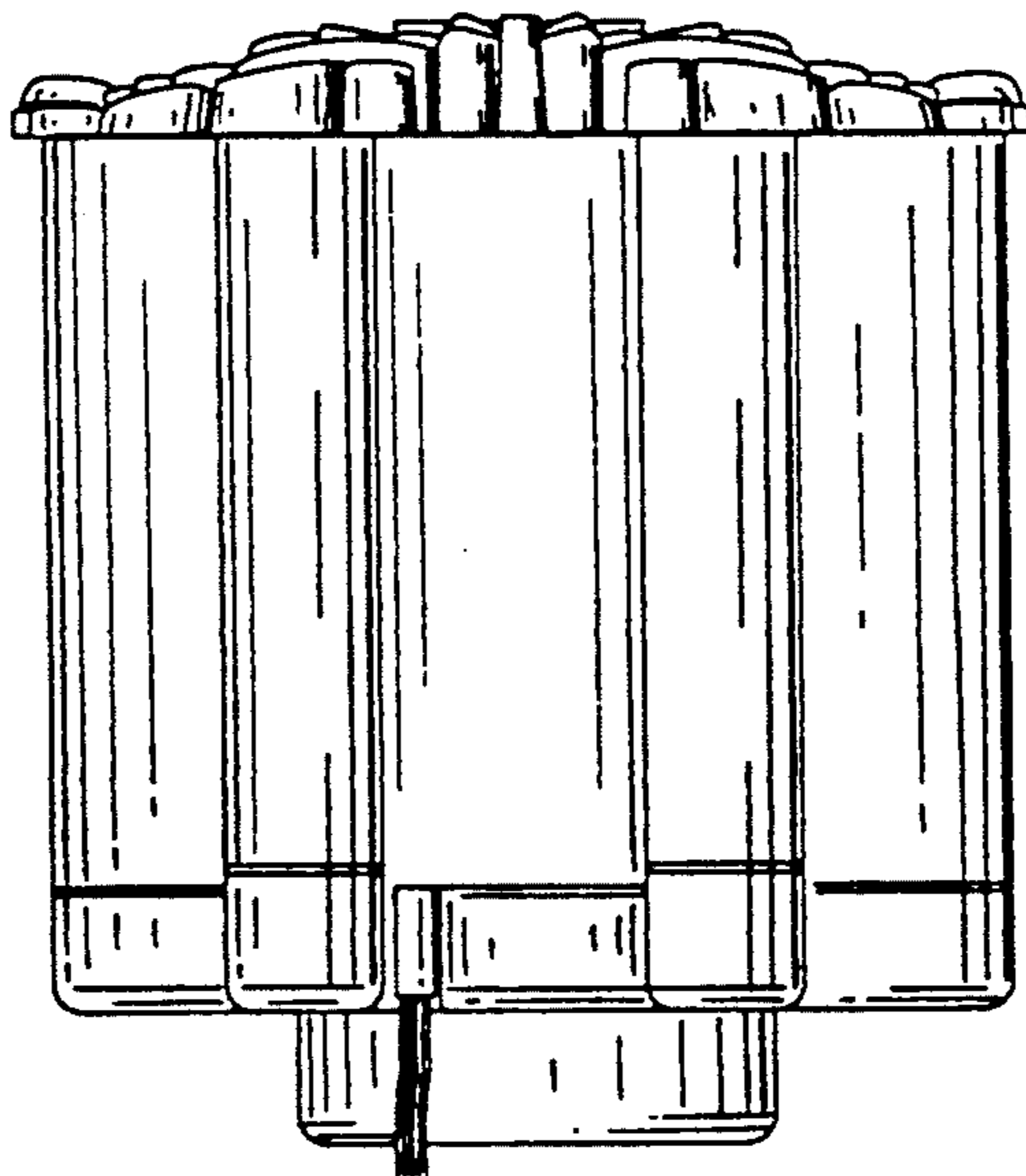

FIG. 10

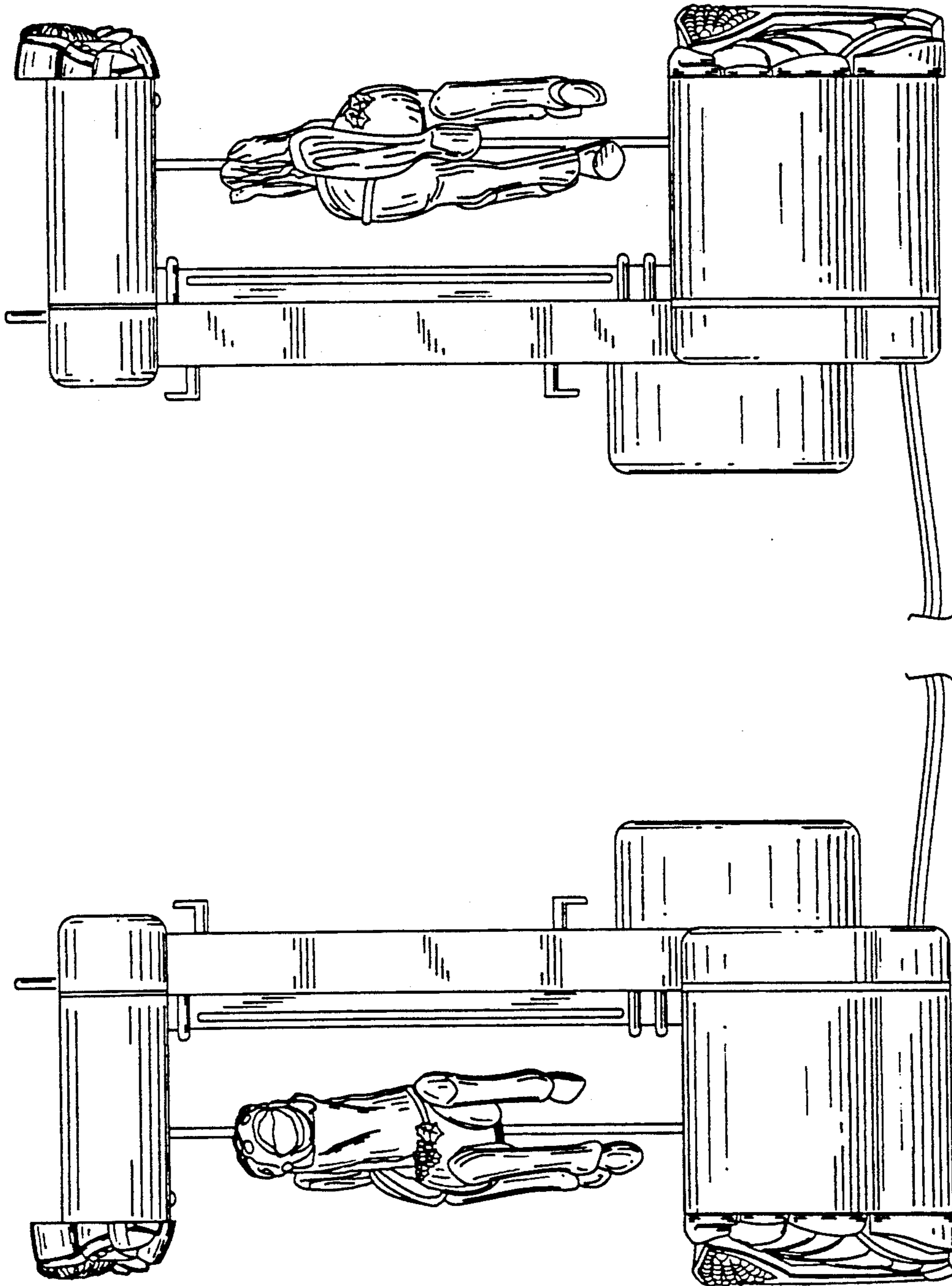

FIG. 12

FIG. 11

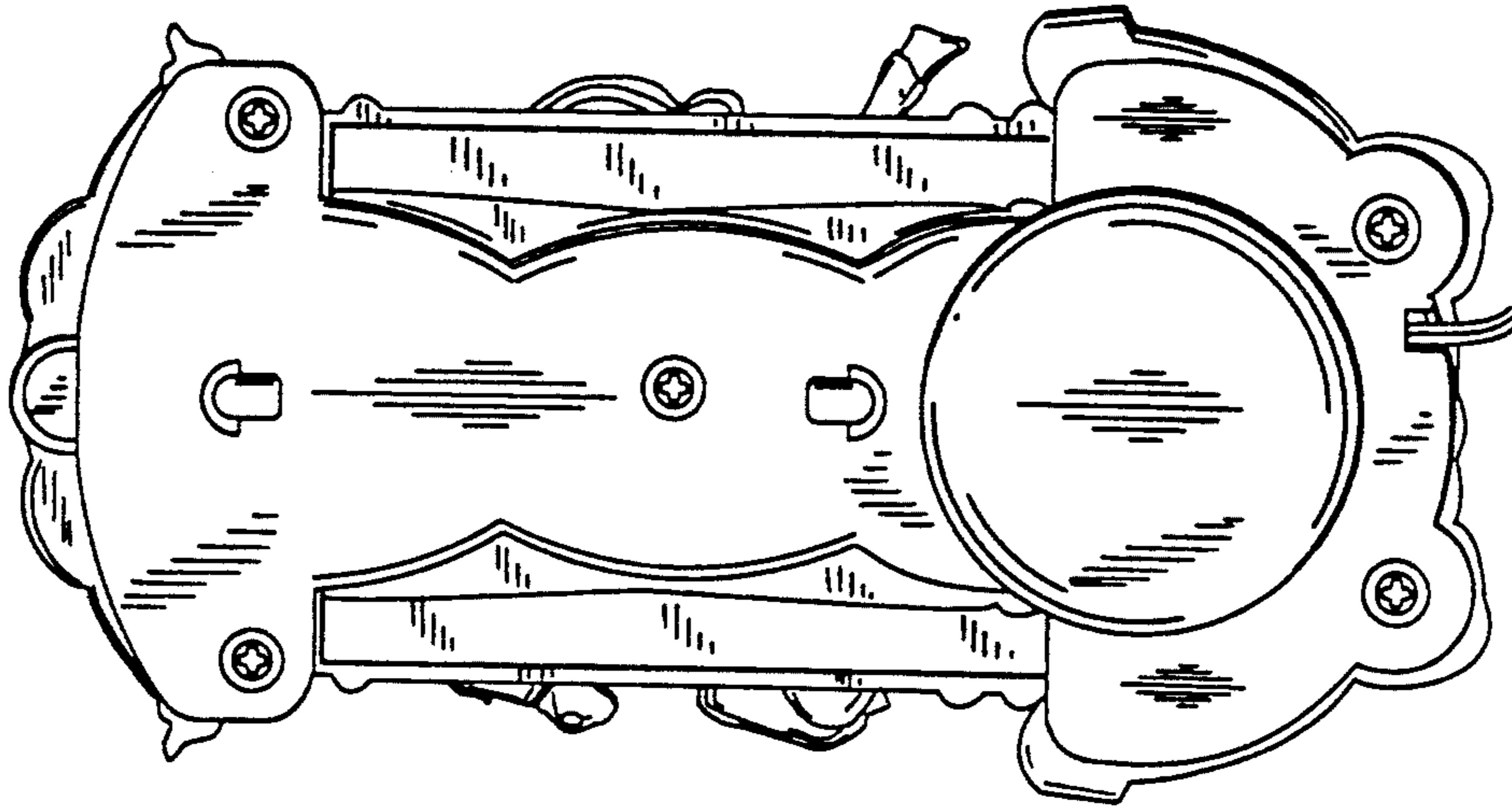

FIG. 14

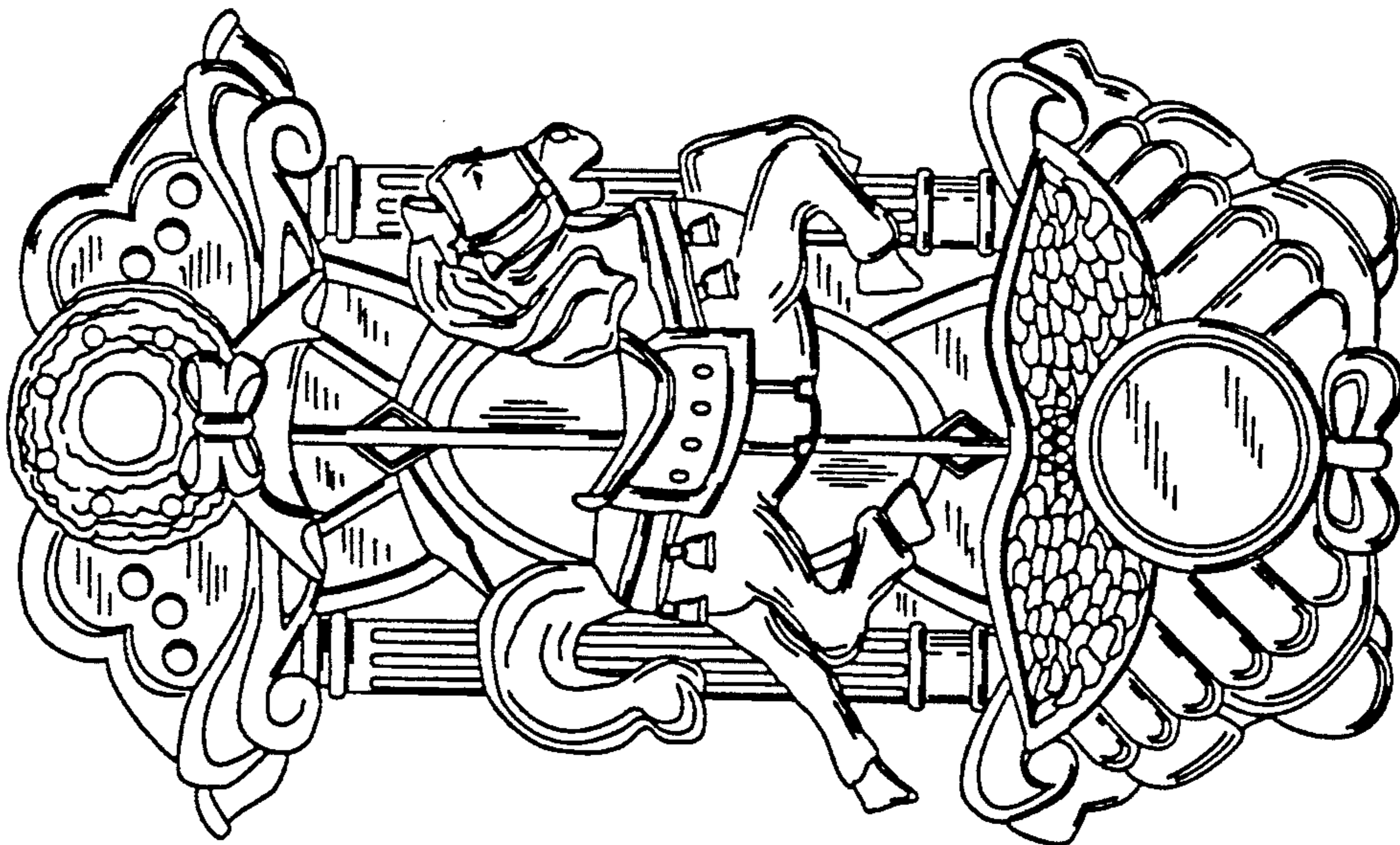

FIG. 13

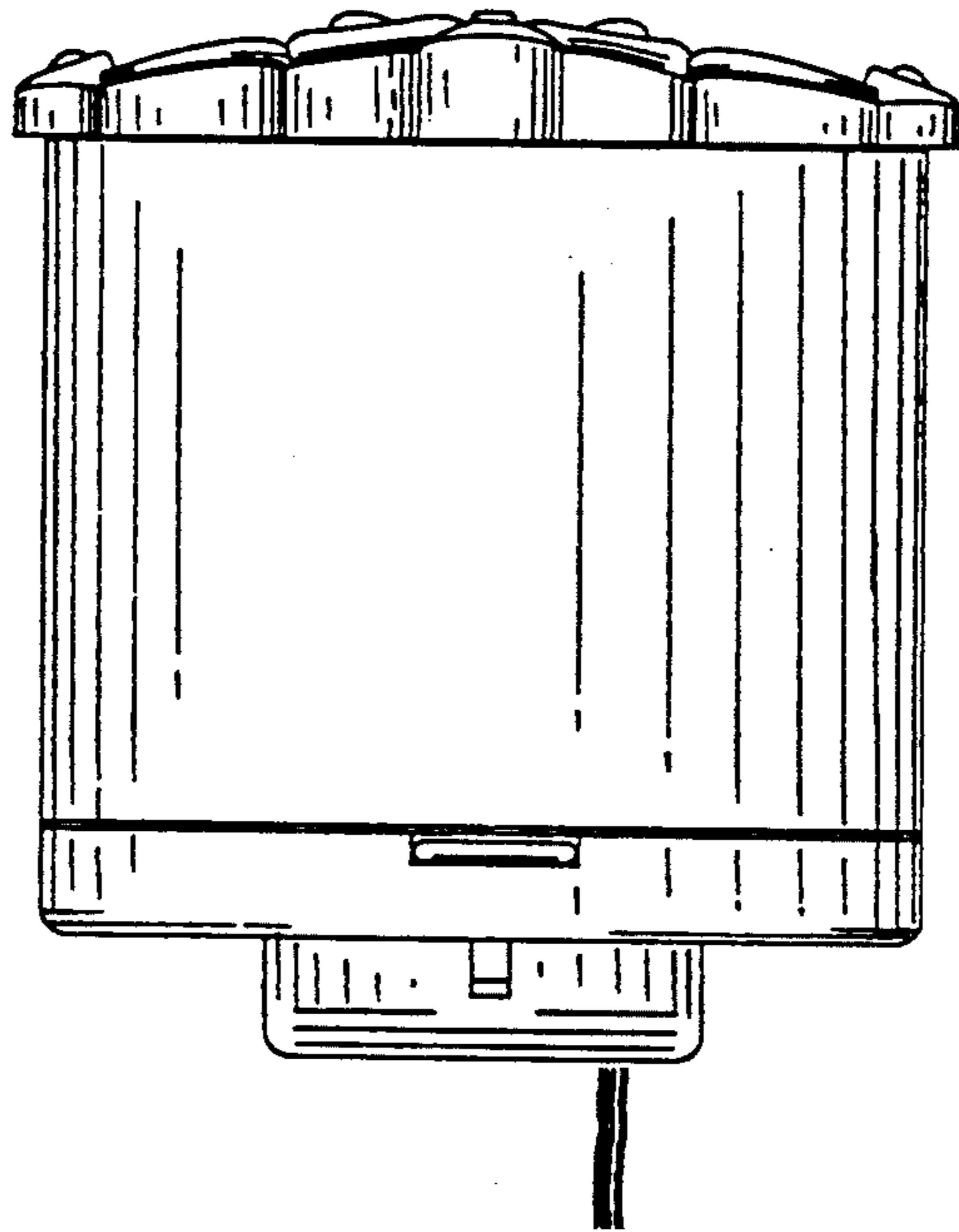

FIG. 15

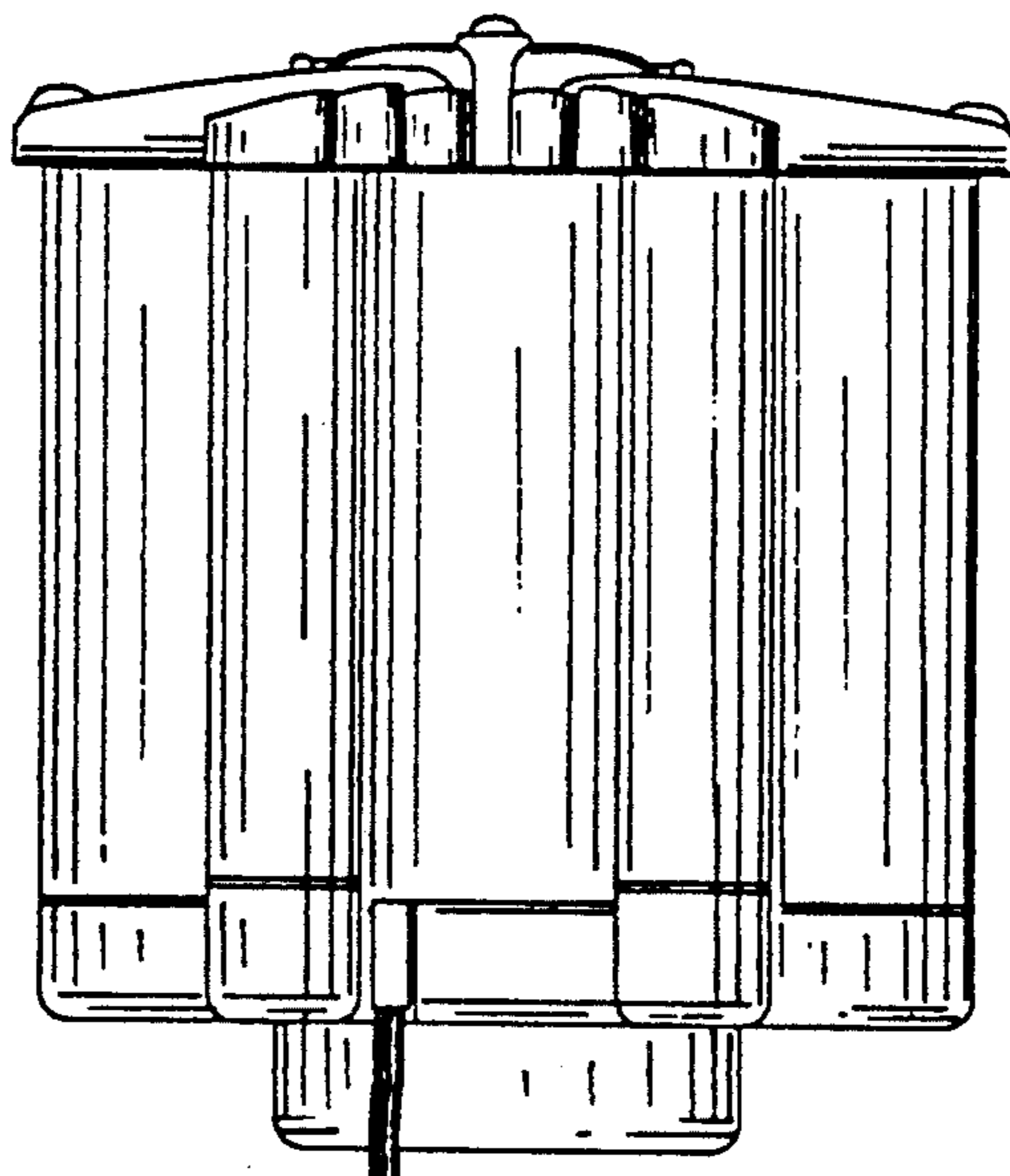

FIG. 16

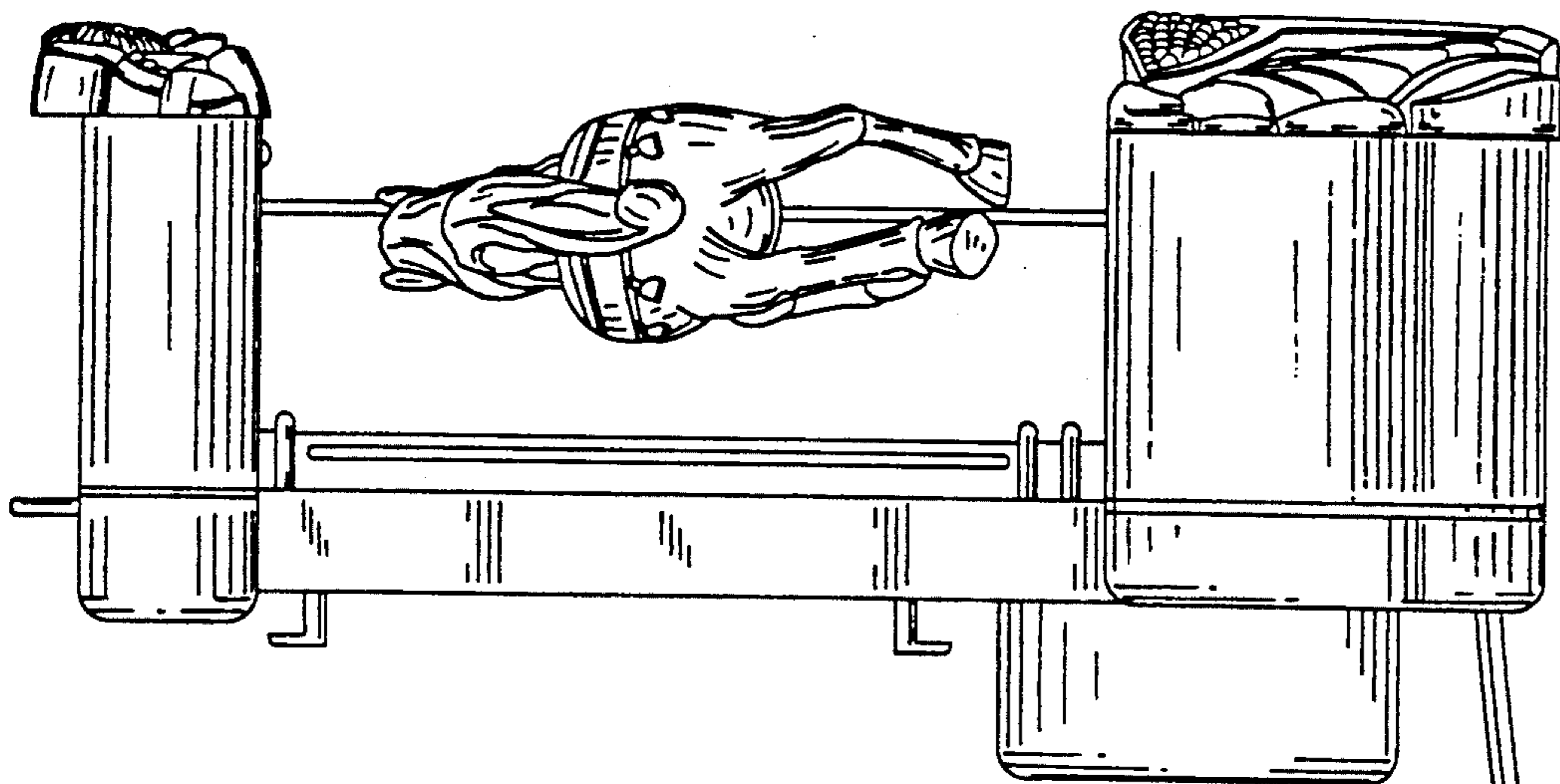

FIG. 18

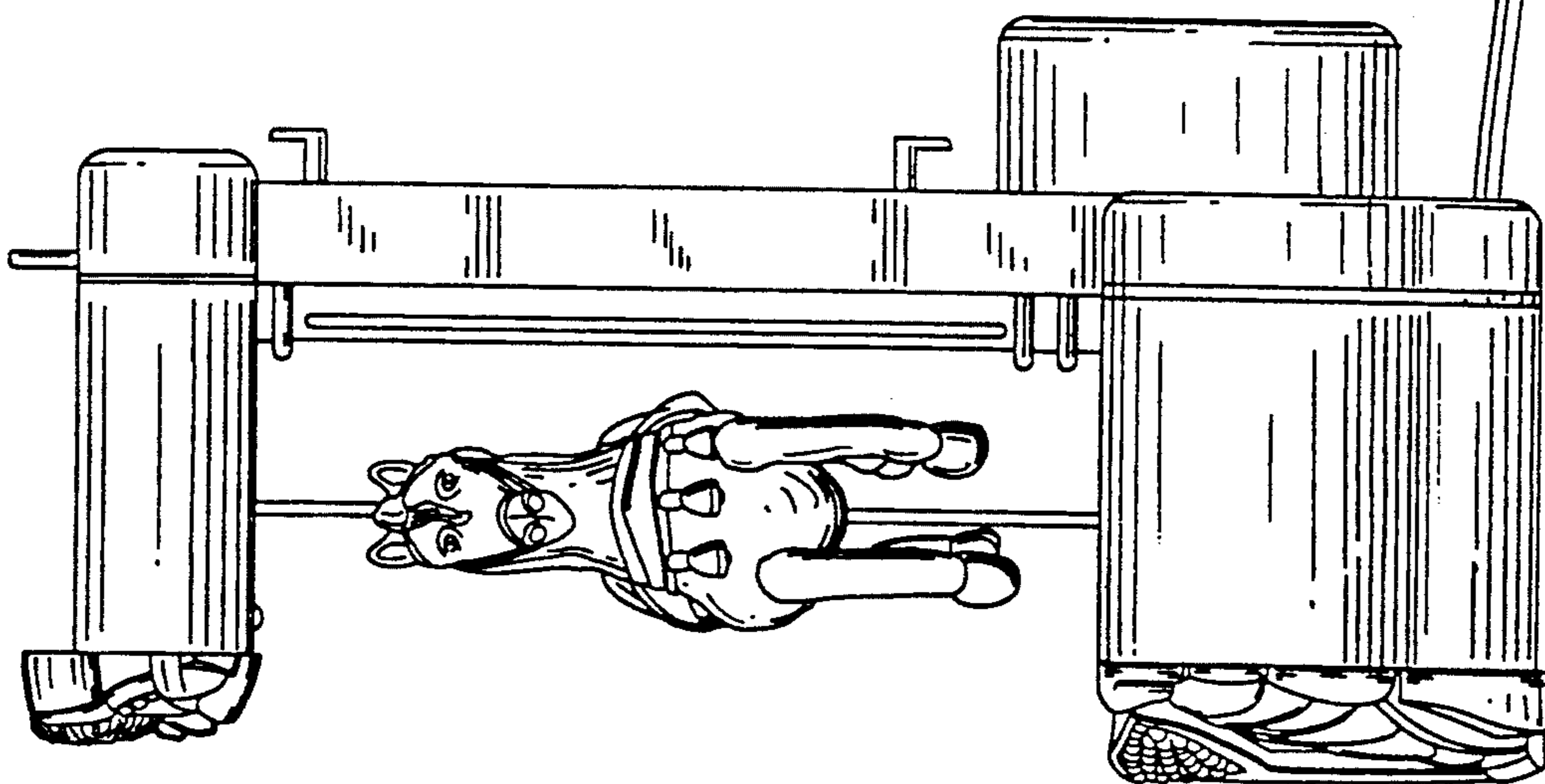

FIG. 17

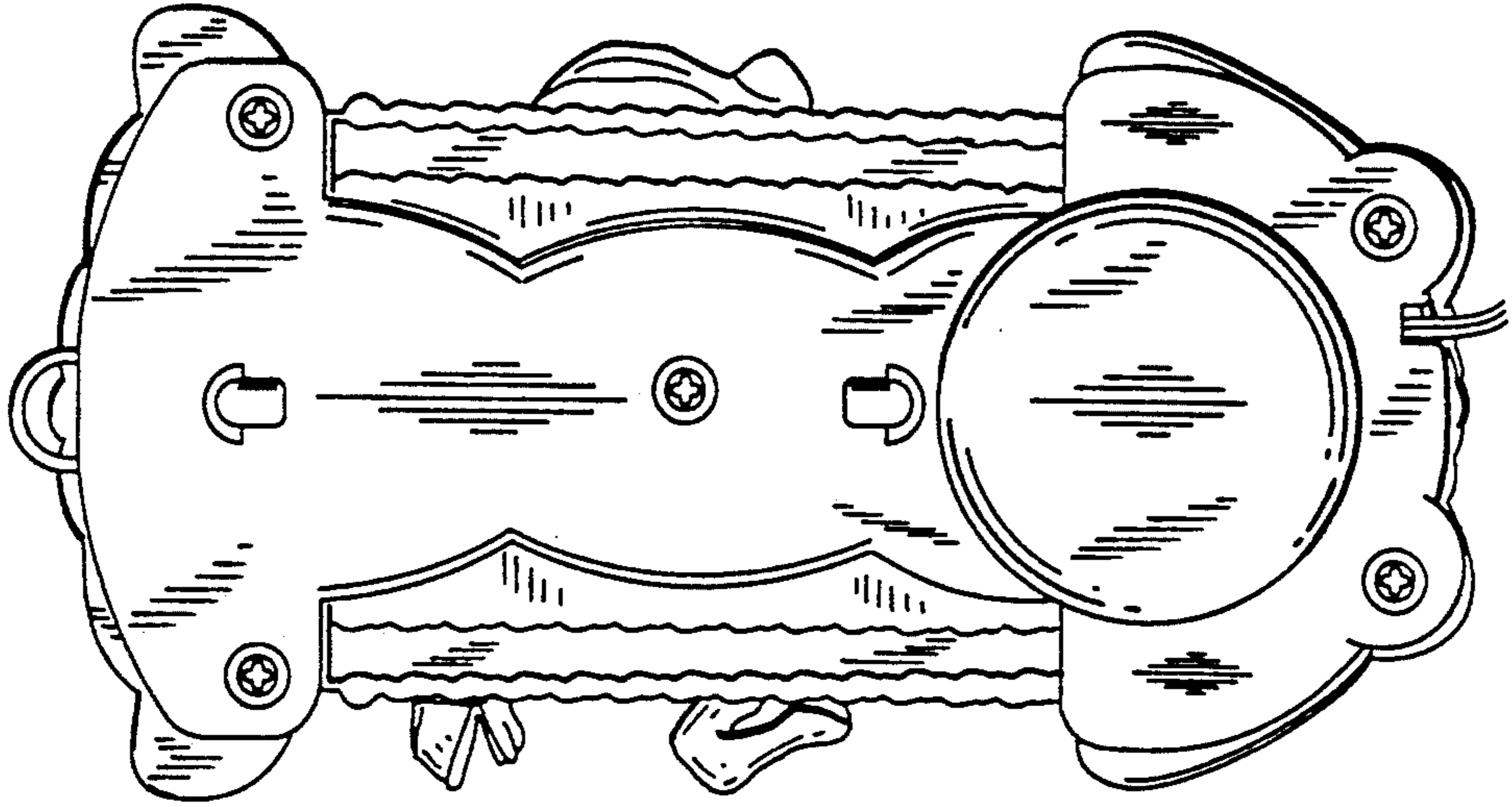

FIG. 20

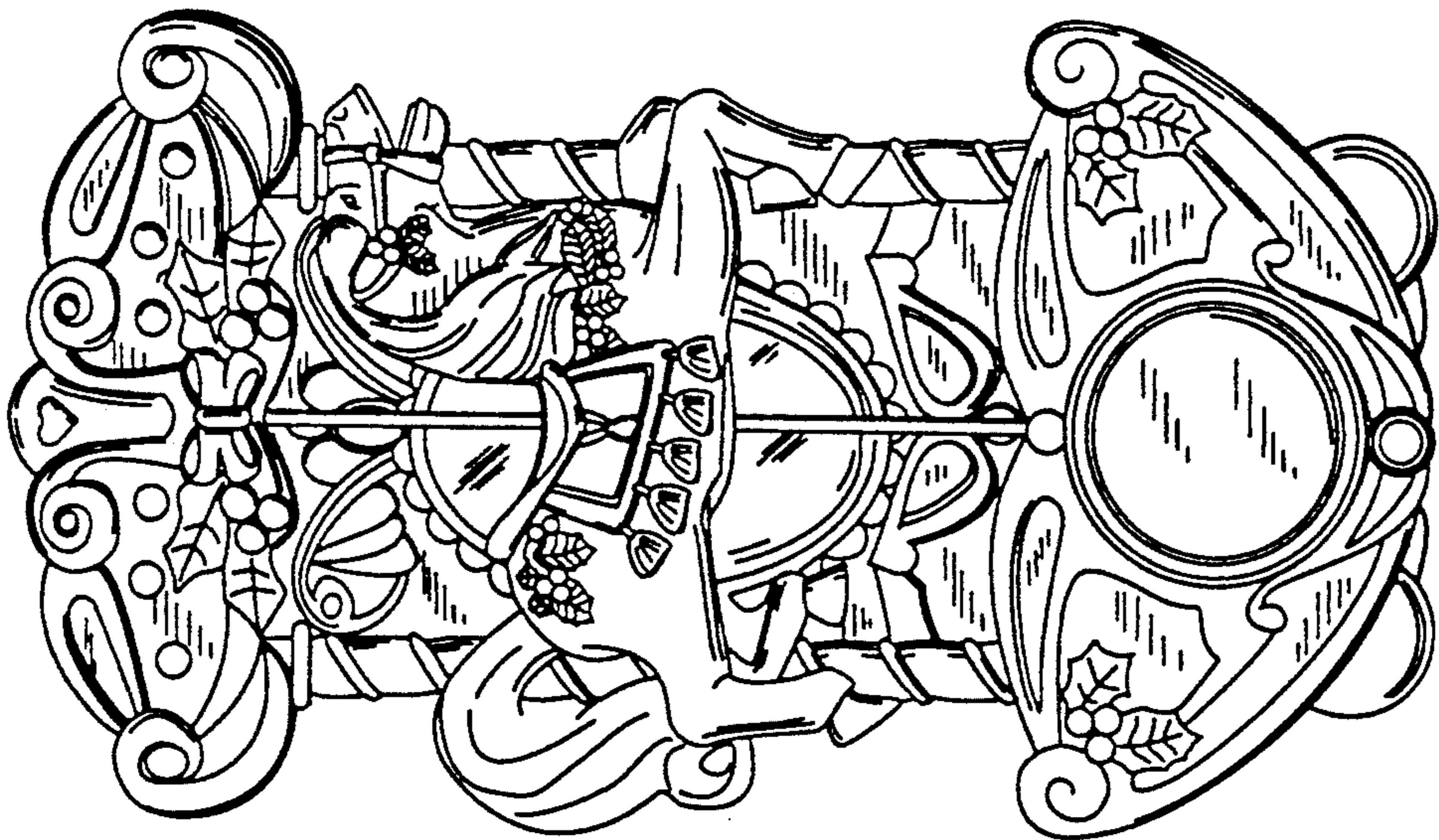

FIG. 19

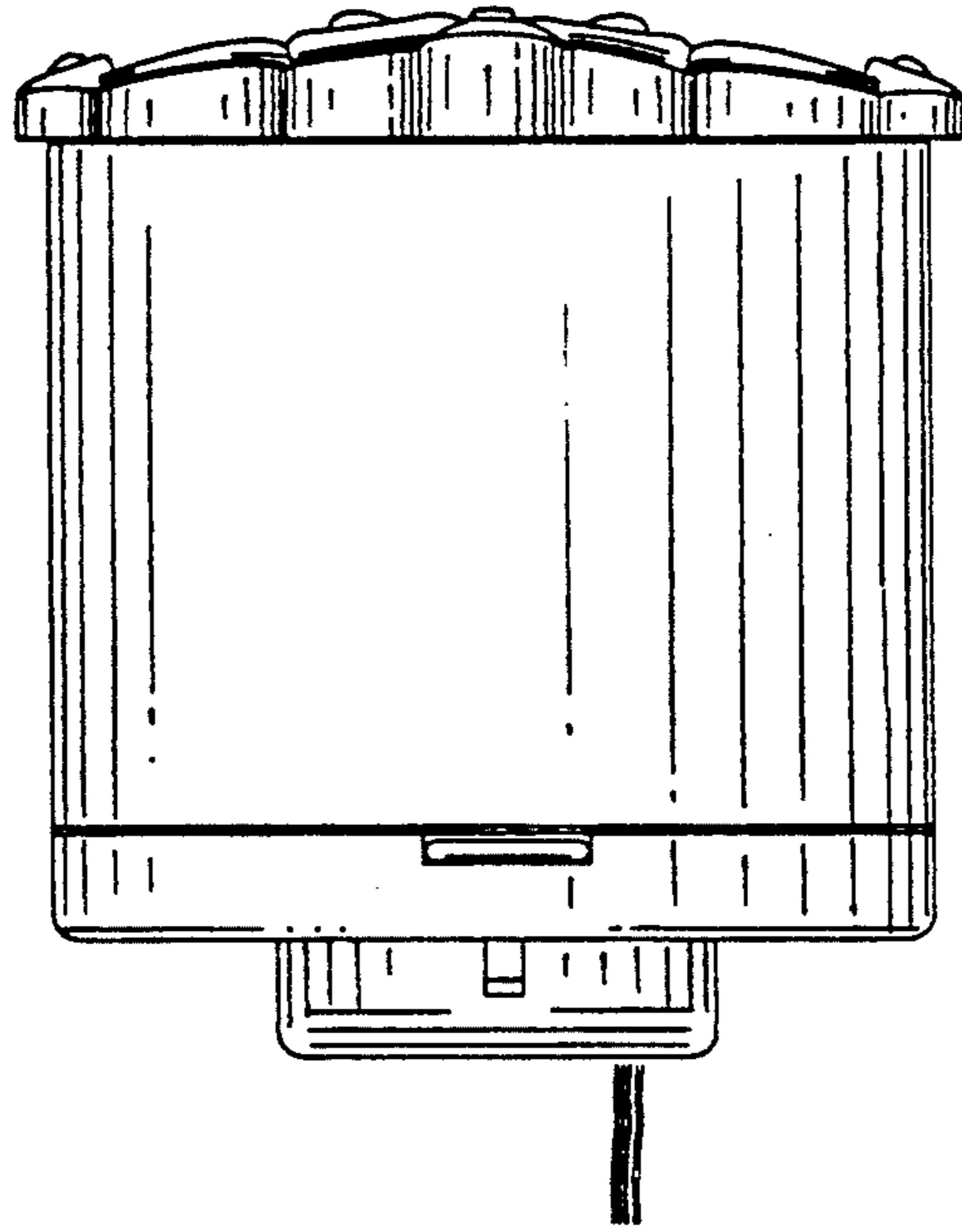

FIG. 21

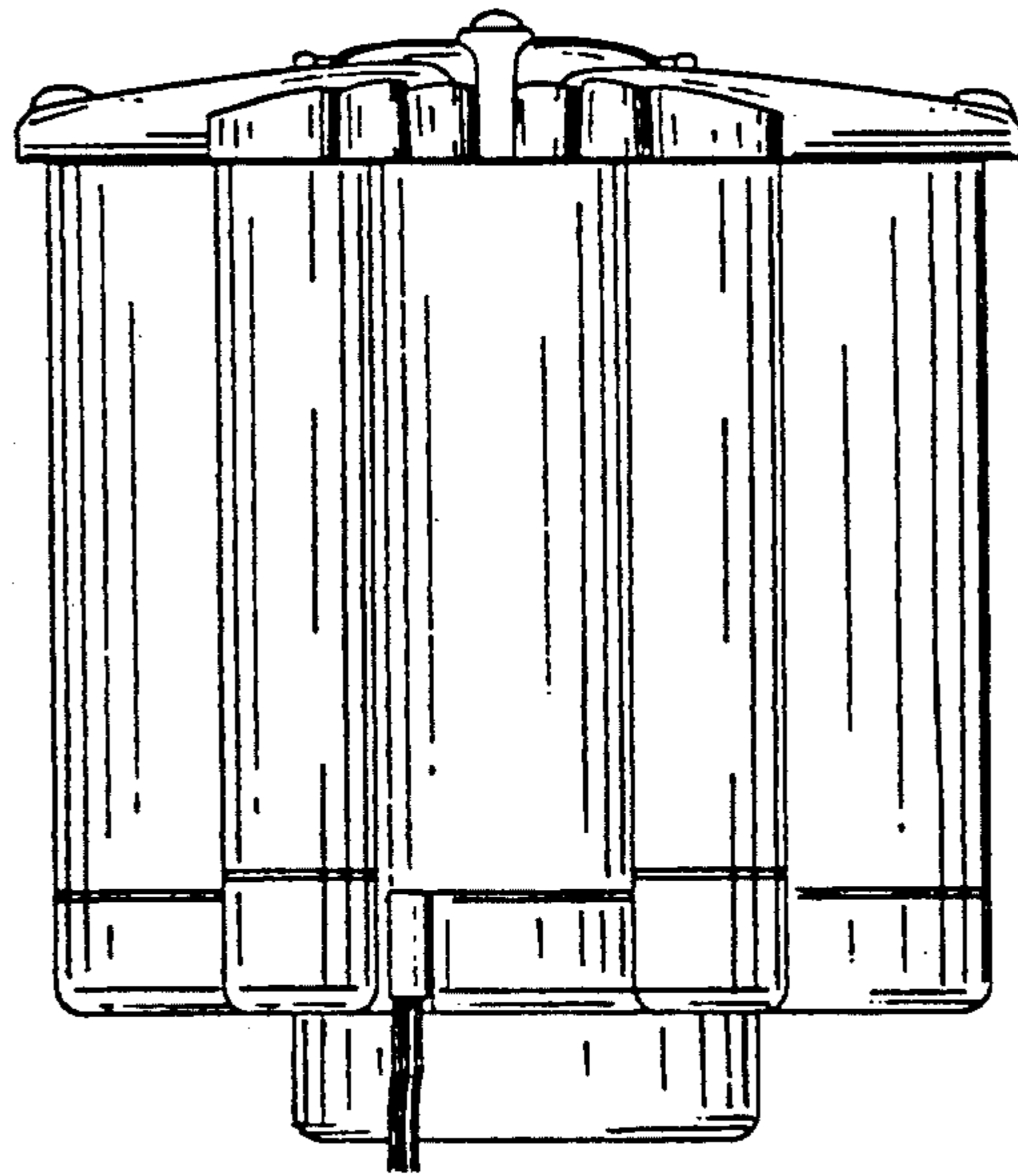

FIG. 22

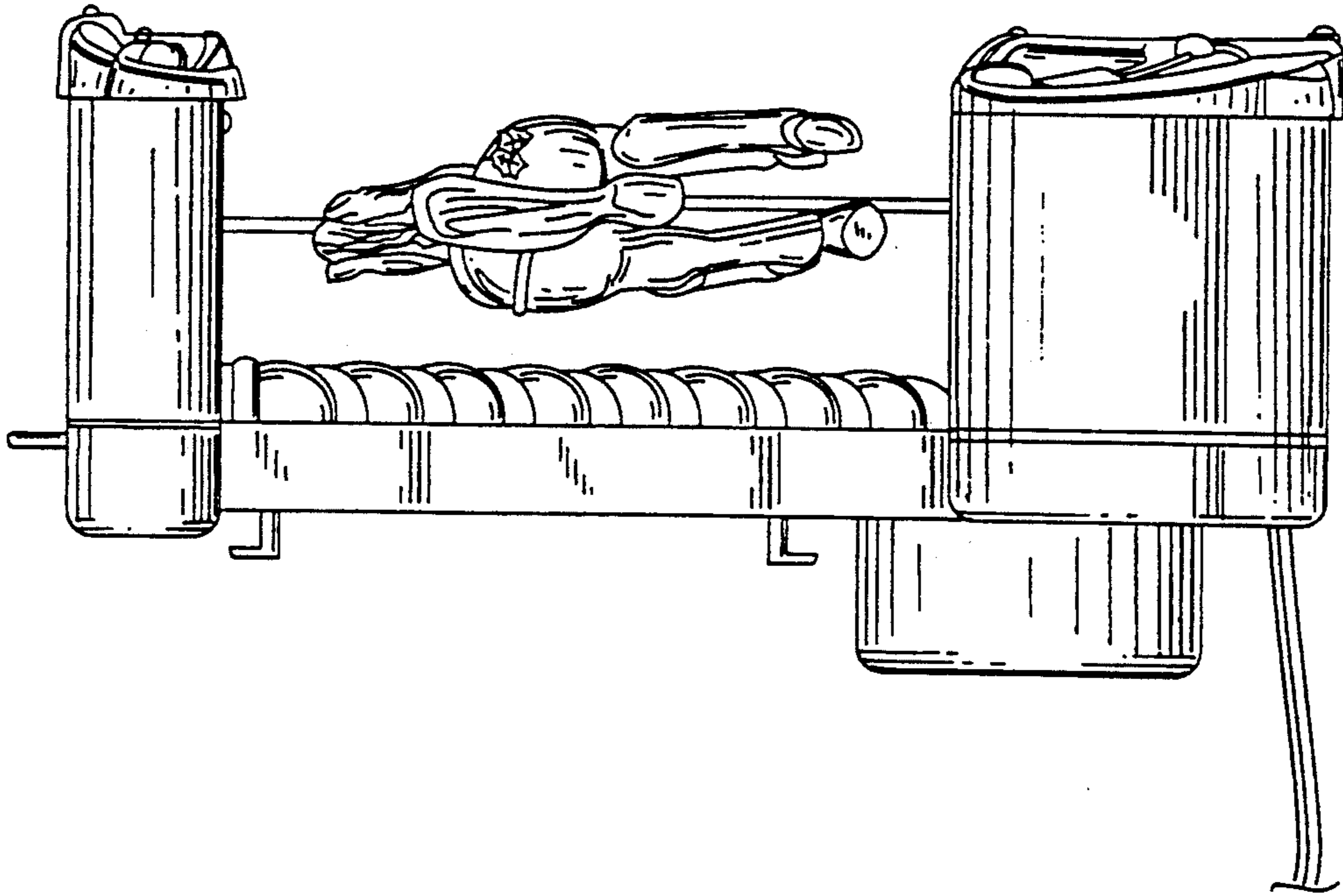

FIG. 24

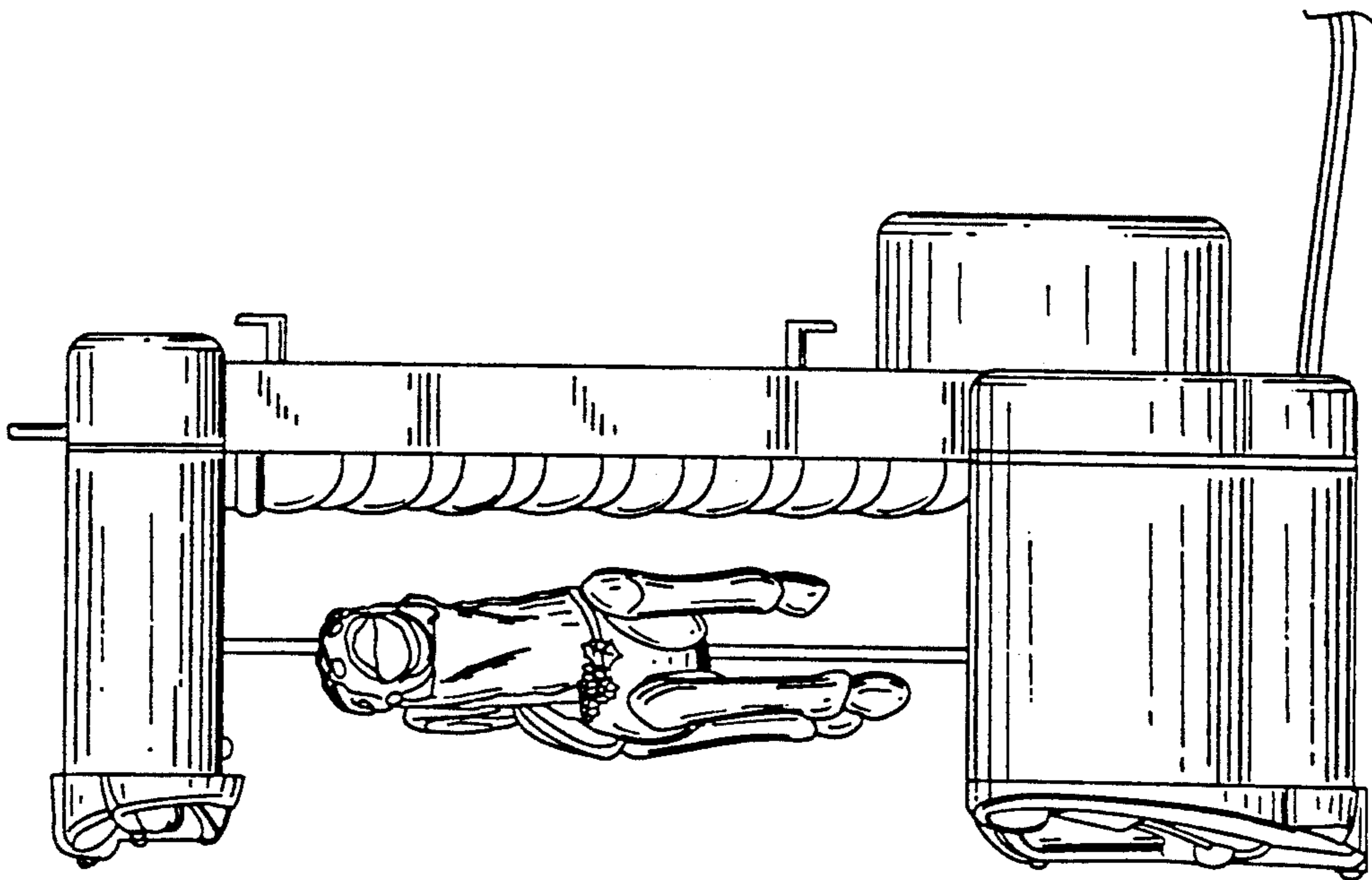

FIG. 23

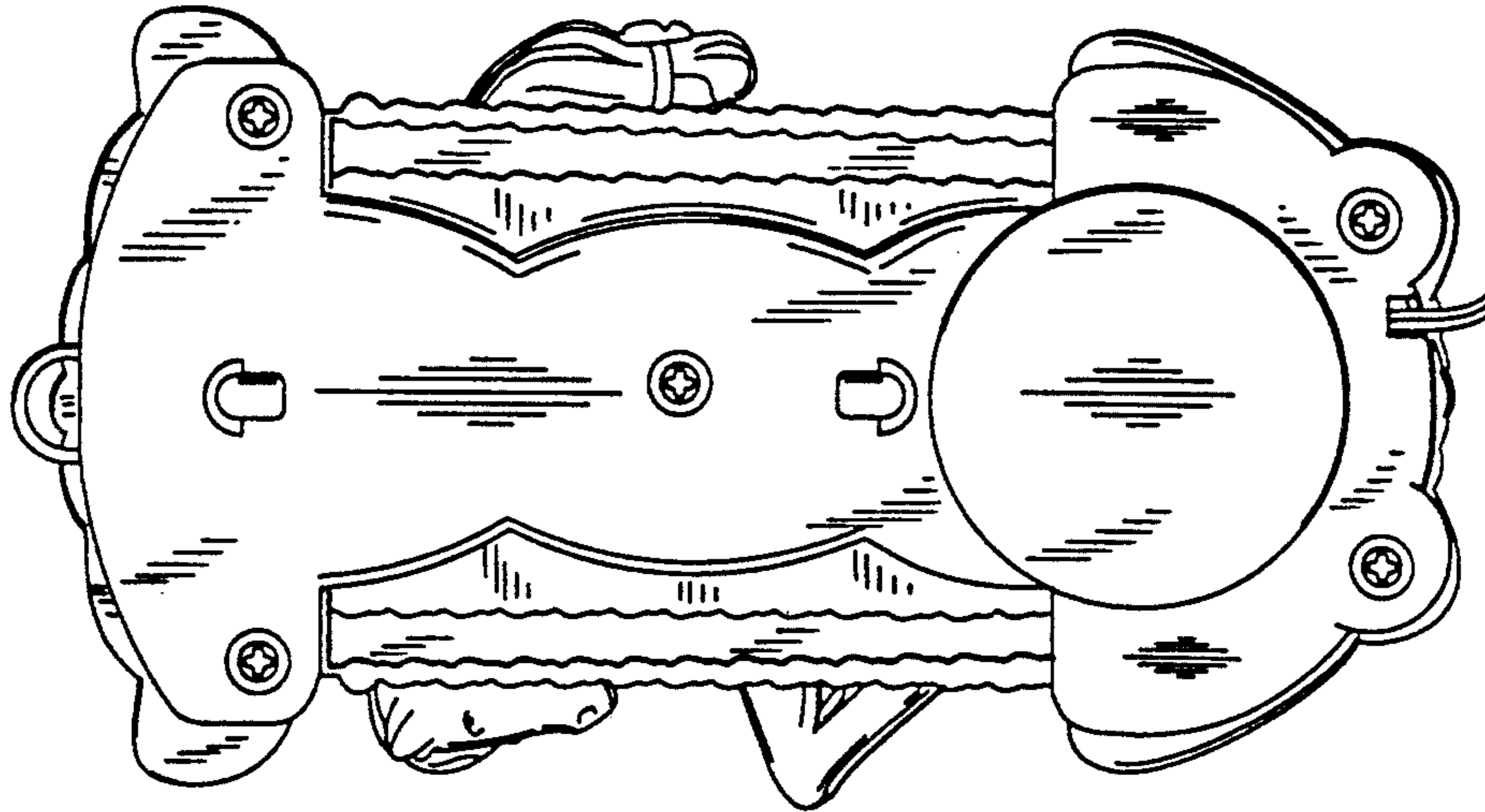

FIG. 26

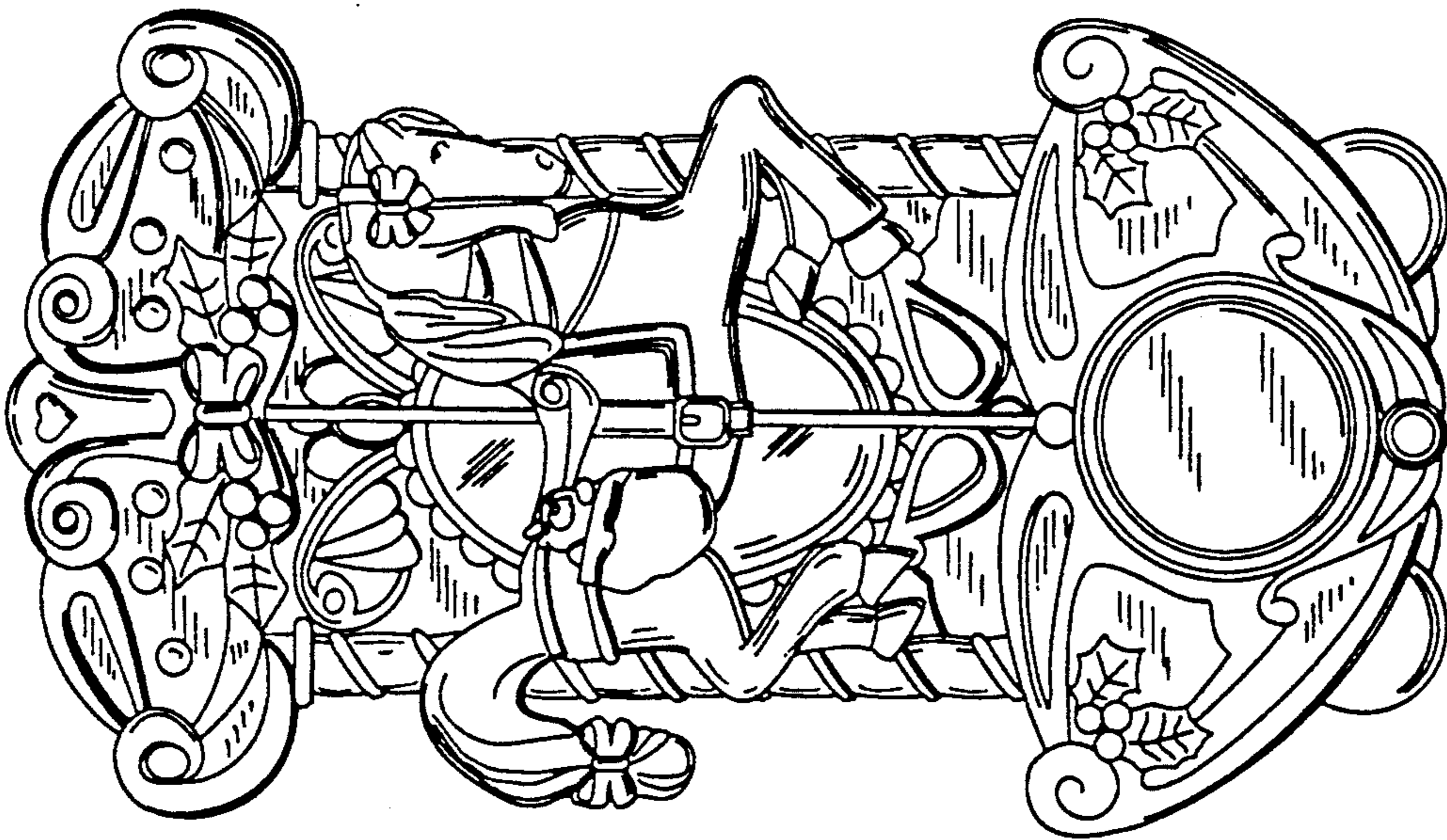

FIG. 25

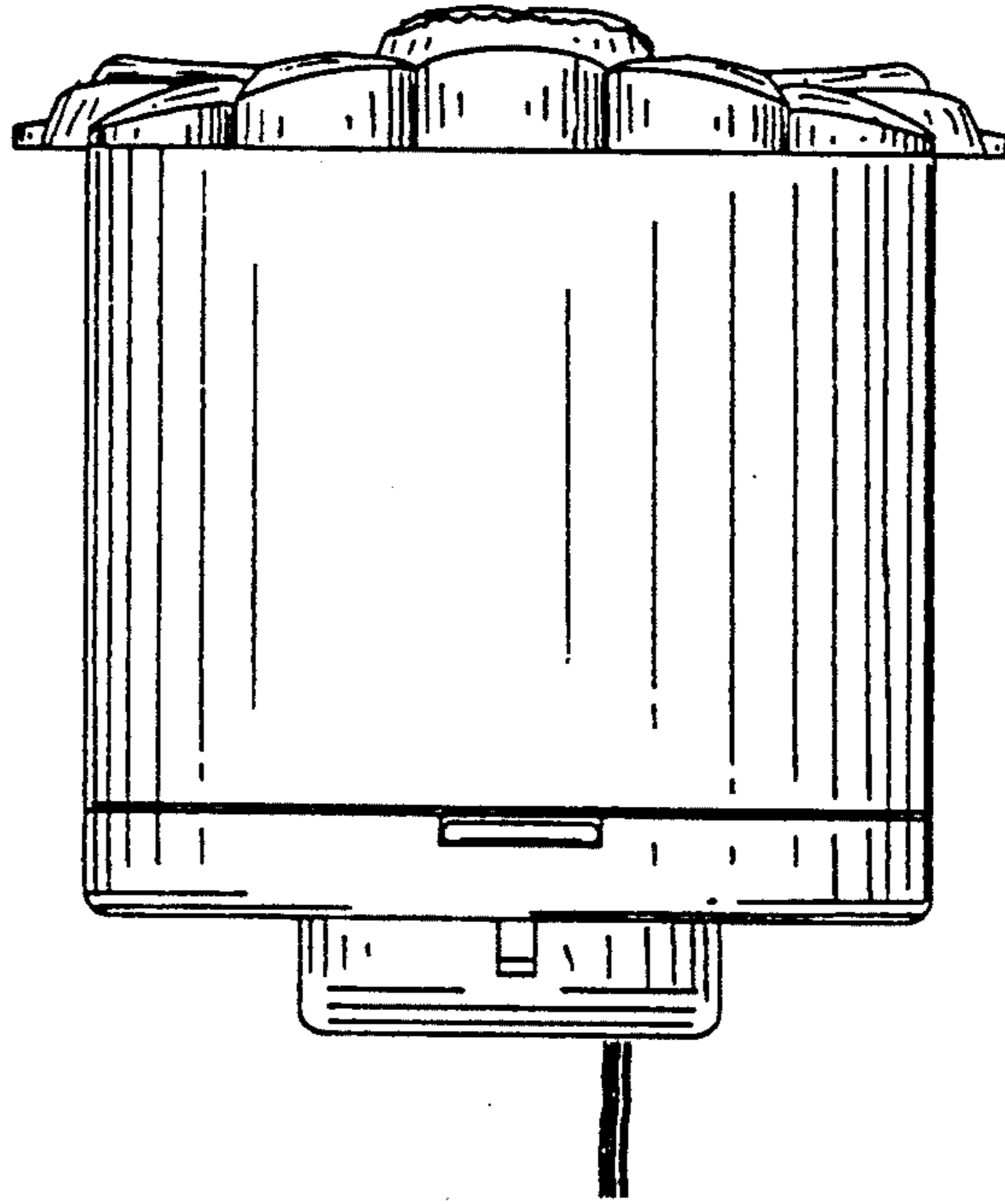

FIG. 27

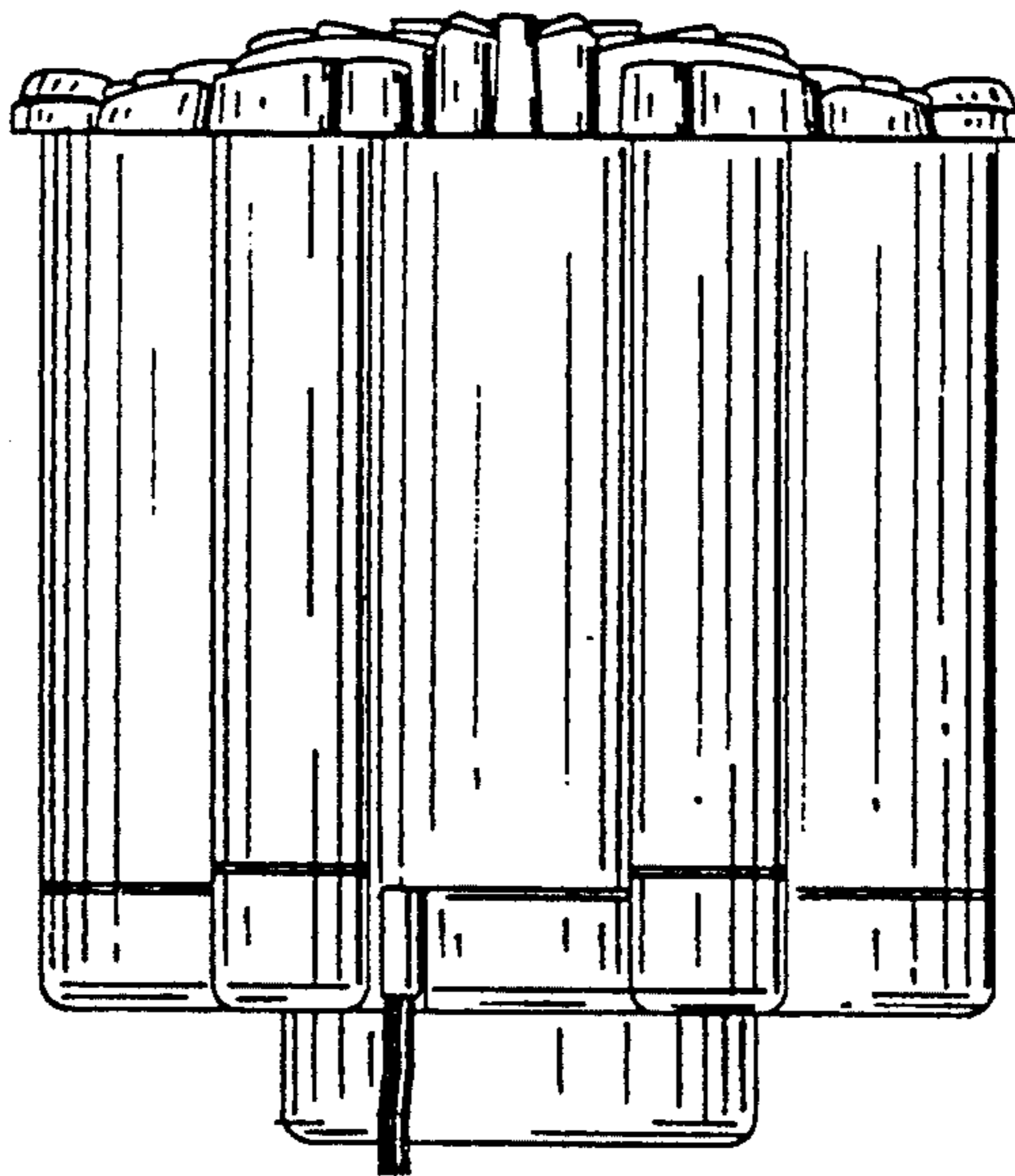

FIG. 28

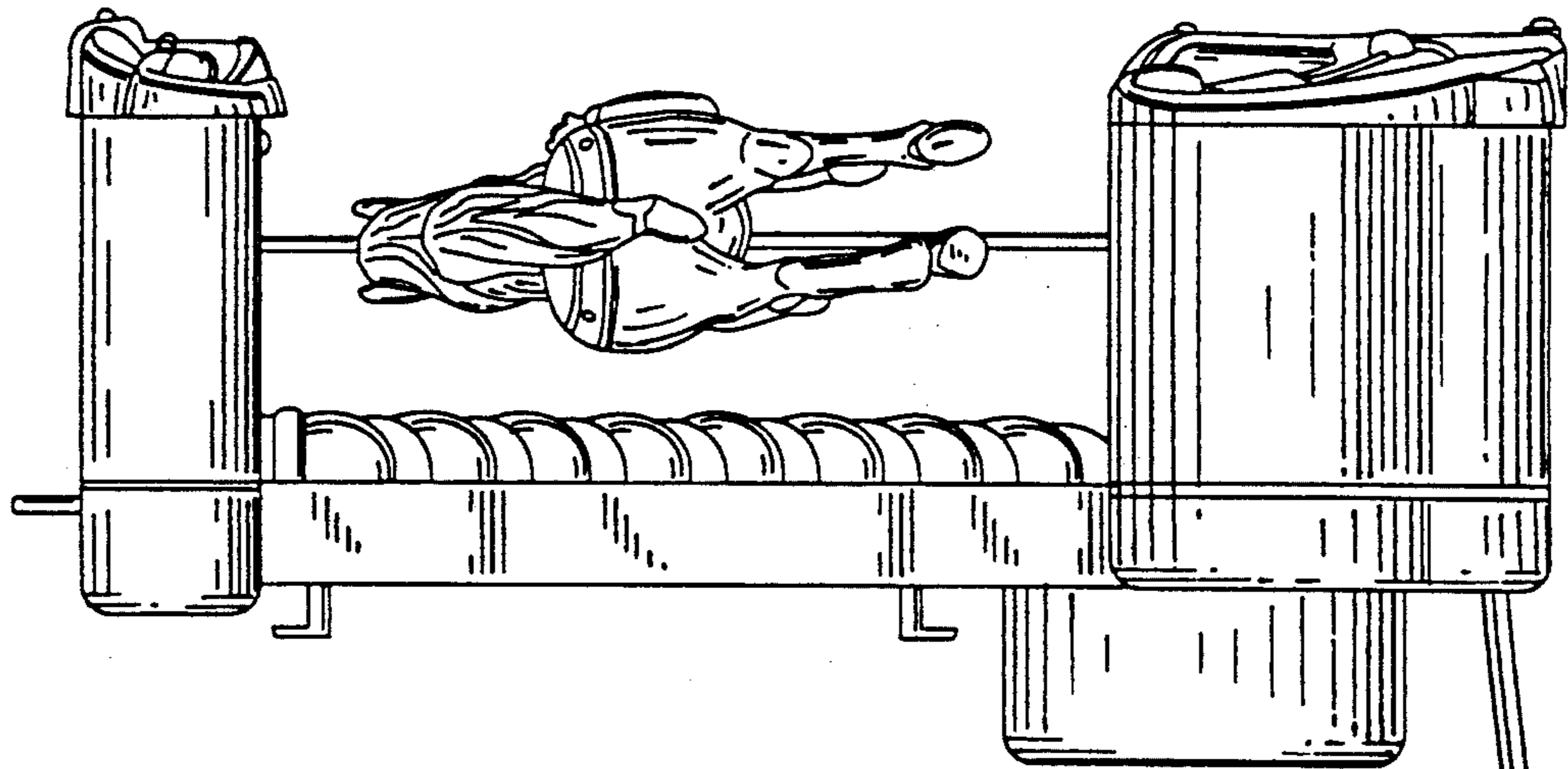

FIG. 30

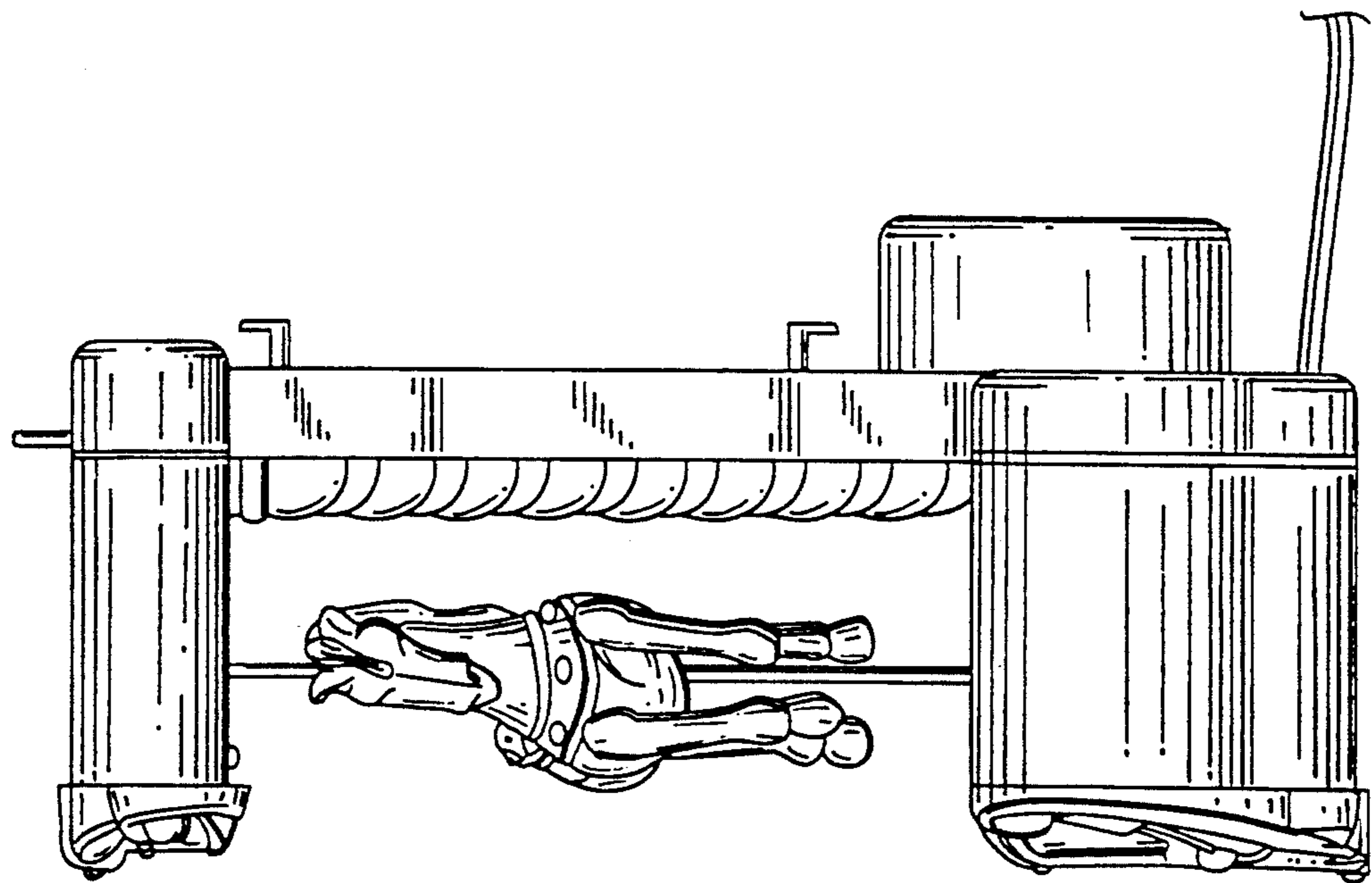

FIG. 29