



US00D347765S

United States Patent [19]

Unkefer

[11] Patent Number: **Des. 347,765**

[45] Date of Patent: **** Jun. 14, 1994**

[54] **COMBINED COOLER AND TAPE PLAYER**

4,571,740 2/1986 Kirby et al. 62/457.1 X

[76] Inventor: **Clifford Unkefer, 105 Riding La.,
Southern Pine, N.C. 28387**

Primary Examiner—Terry A. Wallace
Attorney, Agent, or Firm—Terry M. Gernstein

[**] Term: **14 Years**

[57] **CLAIM**

[21] Appl. No.: **2,746**

The ornamental design for a combined cooler and tape player, as shown and described.

[22] Filed: **Dec. 21, 1992**

DESCRIPTION

[52] U.S. Cl. **D7/605; D14/168**

[58] Field of Search **D7/605-608;
62/371, 457.1, 457.6, 457.7; D14/168, 160-165**

FIG. 1 is a front, top and side perspective view of the combined cooler and tape player showing my new design;

[56] **References Cited**

U.S. PATENT DOCUMENTS

- D. 334,868 4/1993 Woon D7/605
- 3,791,547 2/1974 Brahscum .
- 4,085,785 4/1978 Hoot .

FIG. 2 is a front elevational view thereof;

FIG. 3 is a rear elevational view thereof;

FIG. 4 is a side elevational view thereof, the side opposite being a mirror image of the side shown in FIG. 4;

FIG. 5 is a top plan view thereof; and,

FIG. 6 is a bottom plan view thereof.

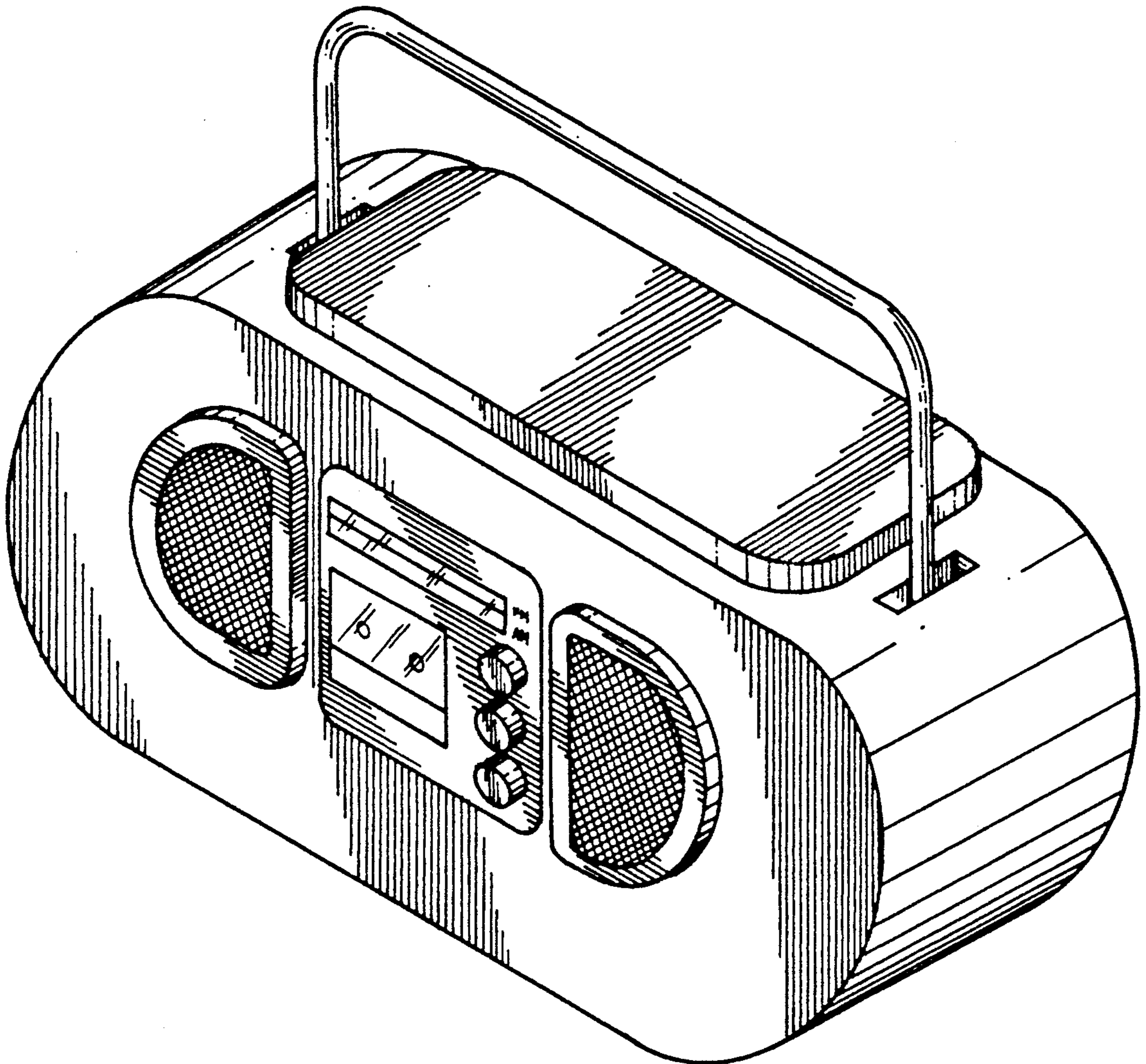
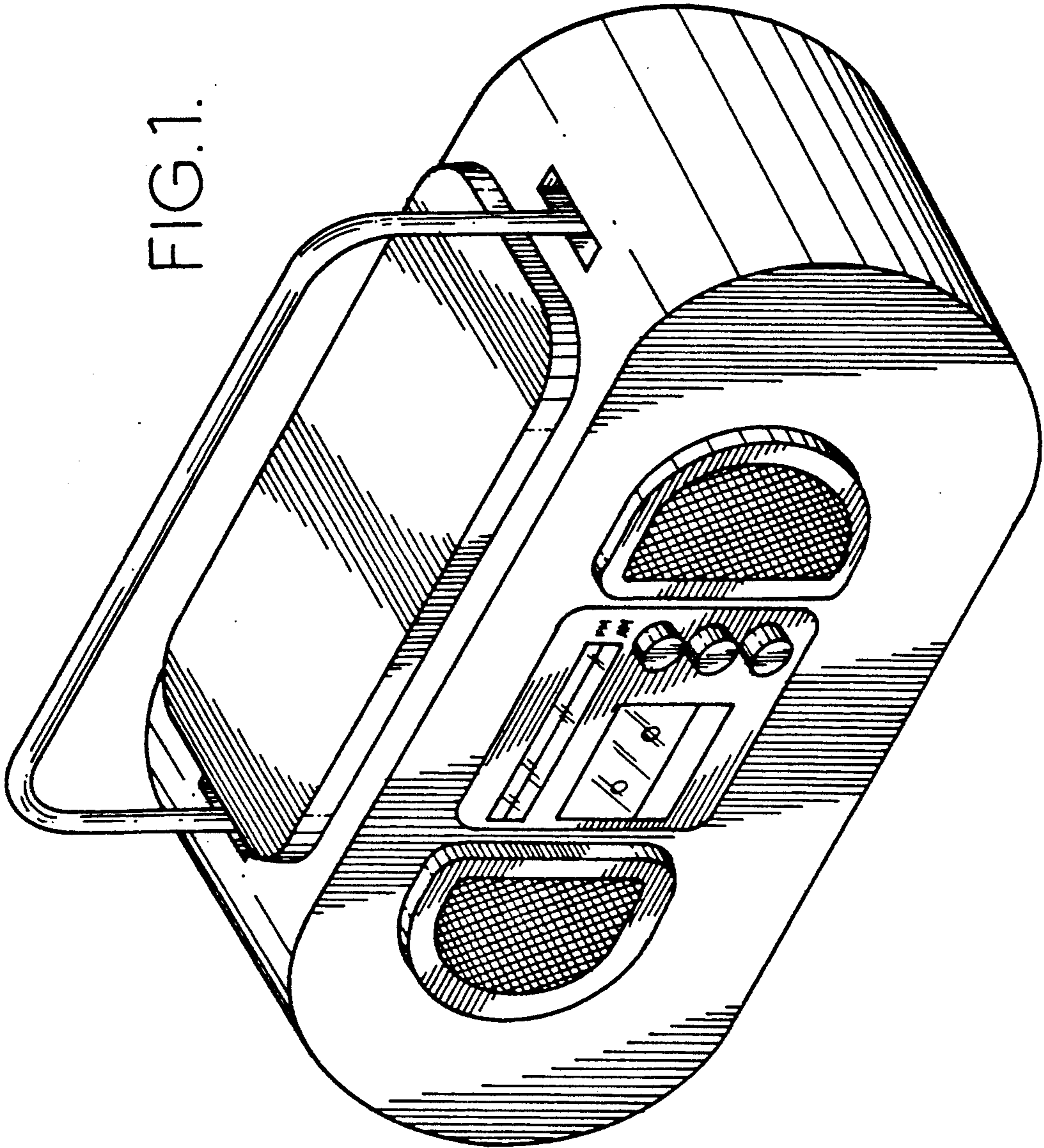

FIG. 1.



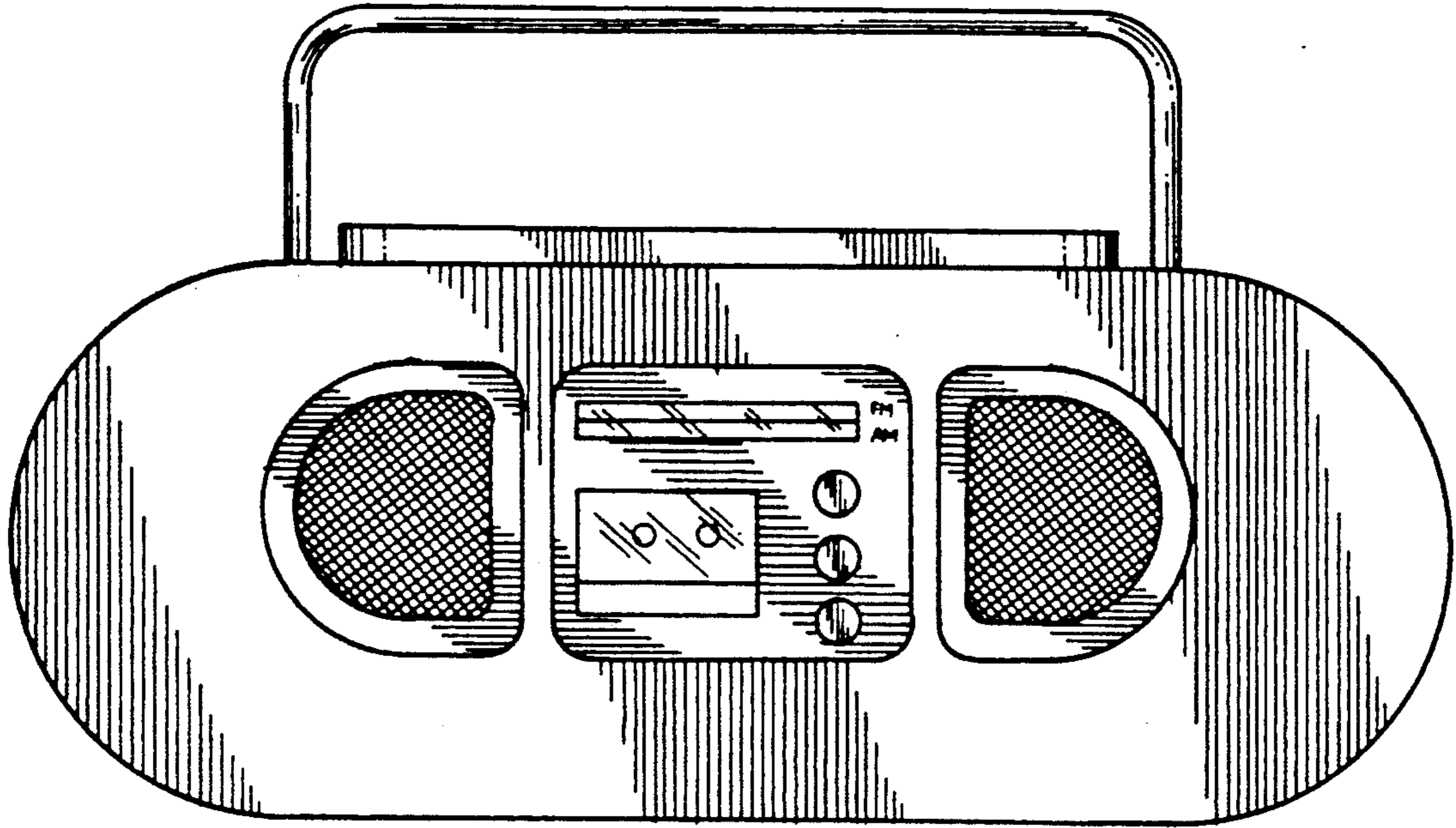
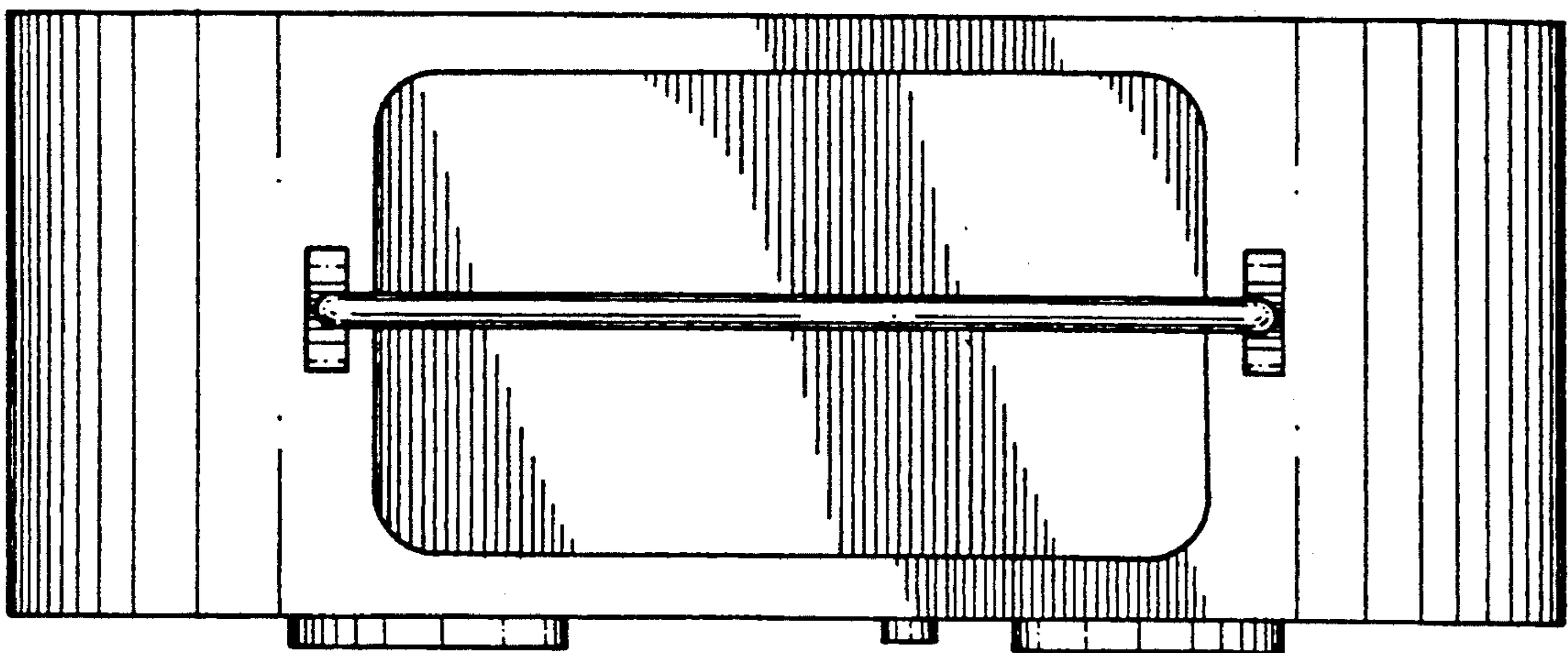

FIG. 2.

FIG. 5.



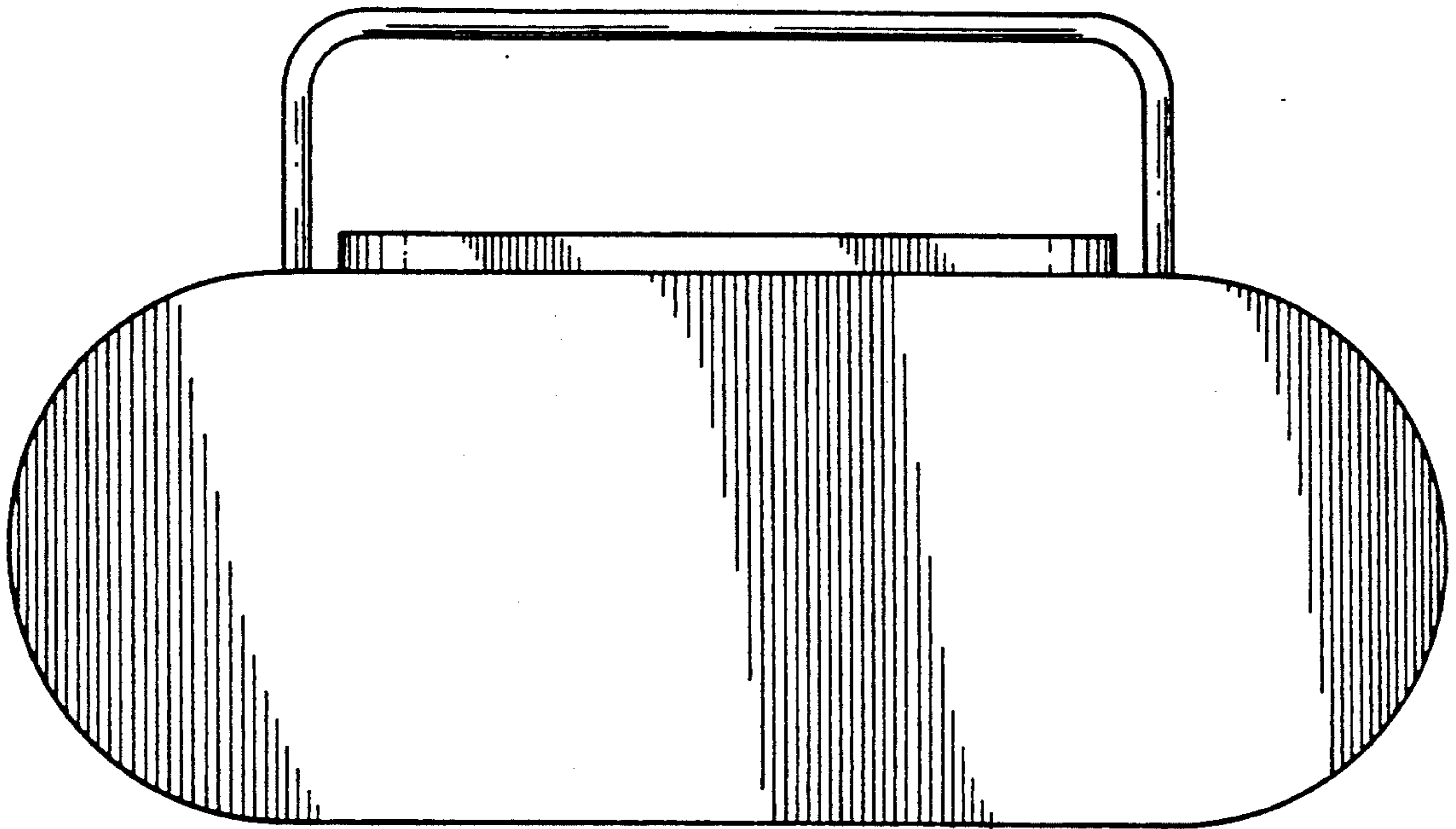

FIG. 3.

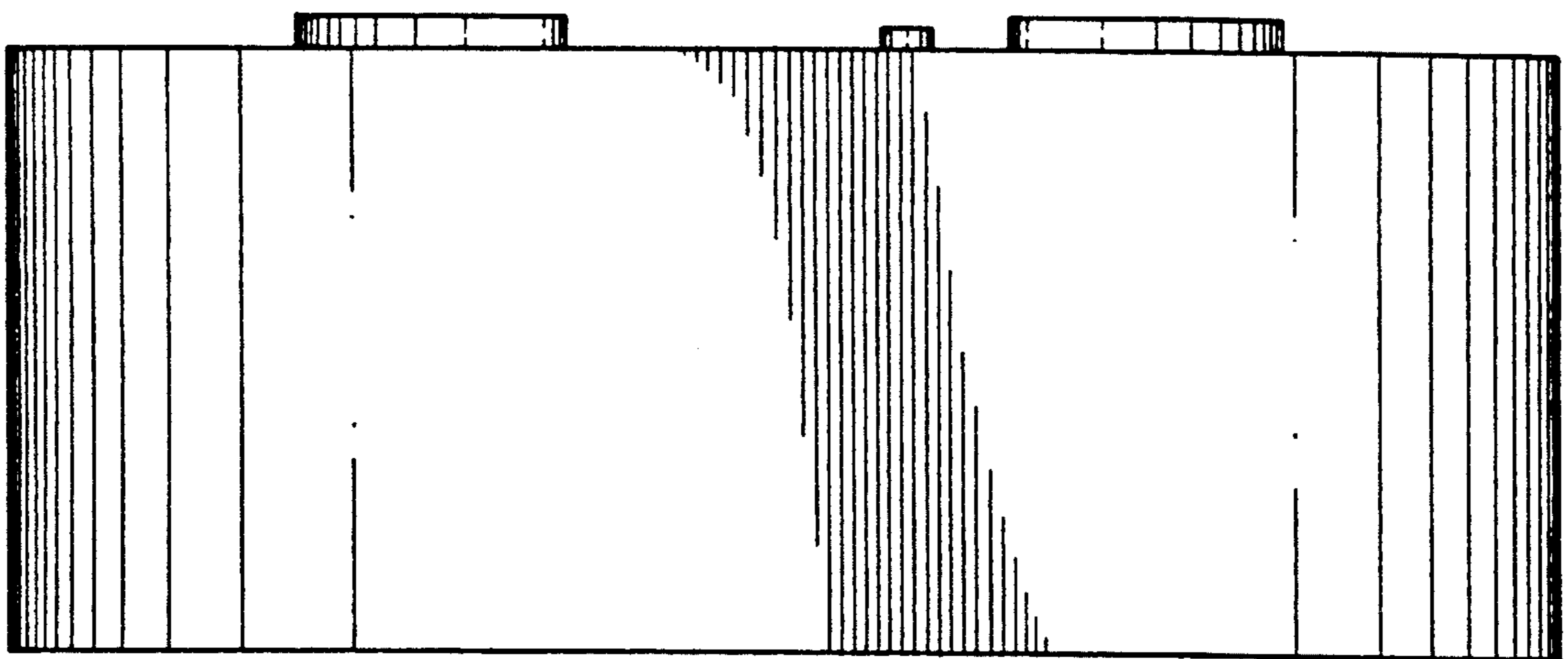

FIG. 6.

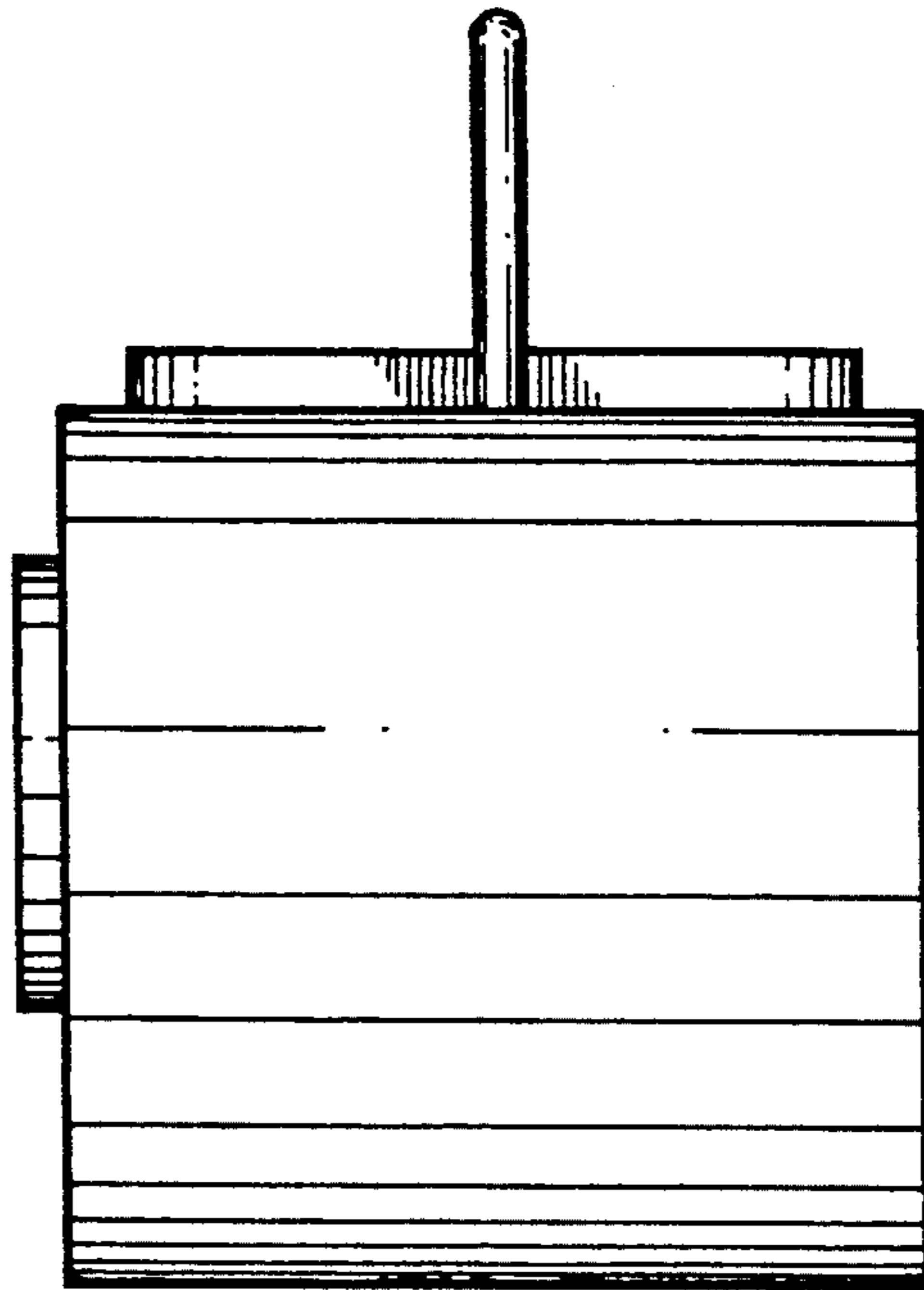

FIG. 4.