



US00D347762S

United States Patent [19]

[11] Patent Number: **Des. 347,762**

Bannigan

[45] Date of Patent: **** Jun. 14, 1994**

[54] **TOASTER**

[56]

References Cited

[75] Inventor: **Francis R. Bannigan, Victoria, Australia**

U.S. PATENT DOCUMENTS

| | | | |
|------------|---------|--------------------|----------|
| D. 241,497 | 9/1976 | Blalock | D7/328 |
| D. 306,249 | 2/1990 | Tamada et al. | D7/330 X |
| D. 328,686 | 8/1992 | Wolfe | D7/330 |
| 4,889,042 | 12/1989 | Hantz et al. | D7/329 X |

[73] Assignee: **Kambrook Distributing Pty. Ltd., Australia**

Primary Examiner—Alan P. Douglas
Assistant Examiner—Caron D. Veynar
Attorney, Agent, or Firm—Andrus, Scales, Starke & Sawall

[**] Term: **14 Years**

[57]

CLAIM

[21] Appl. No.: **858,767**

The ornamental design for a toaster, as shown.

[22] Filed: **Mar. 27, 1992**

DESCRIPTION

[30] Foreign Application Priority Data

| | | | |
|---------------|-----------------|-----------------|---|
| Sep. 30, 1991 | [AU] | Australia | 2941/91 |
| [52] | U.S. Cl. | | D7/328; D7/323 |
| [58] | Field of Search | | D7/323, 328-330, D7/390; 99/372, 385, 389 |

FIG. 1 is a left side elevation;
FIG. 2 is a right side elevation;
FIG. 3 is a perspective view from right side and above;
FIG. 4 is a perspective view from left side and below;
FIG. 5 is a front elevation;
FIG. 6 is a rear elevation;
FIG. 7 is a top plan view; and,
FIG. 8 is a bottom plan view.

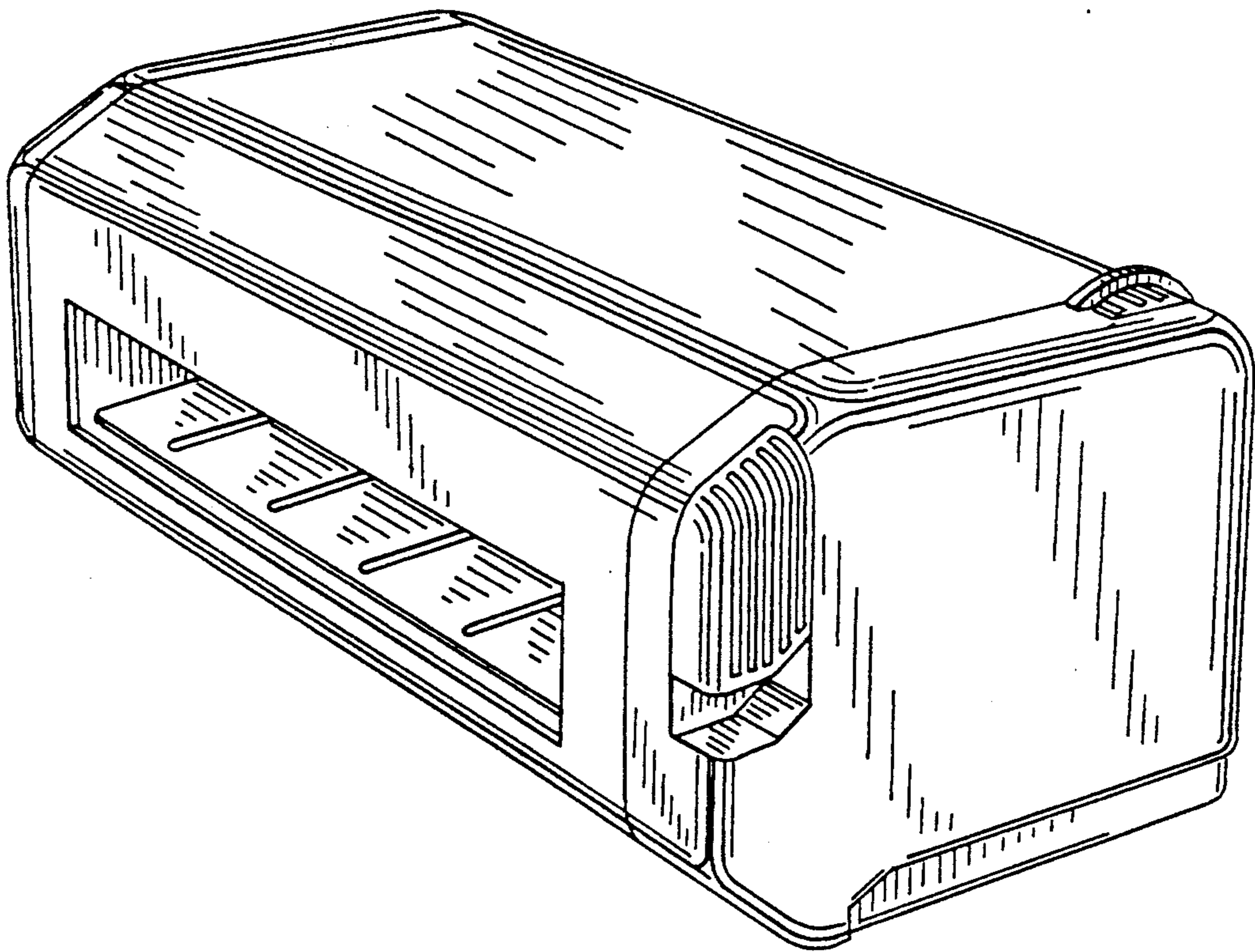

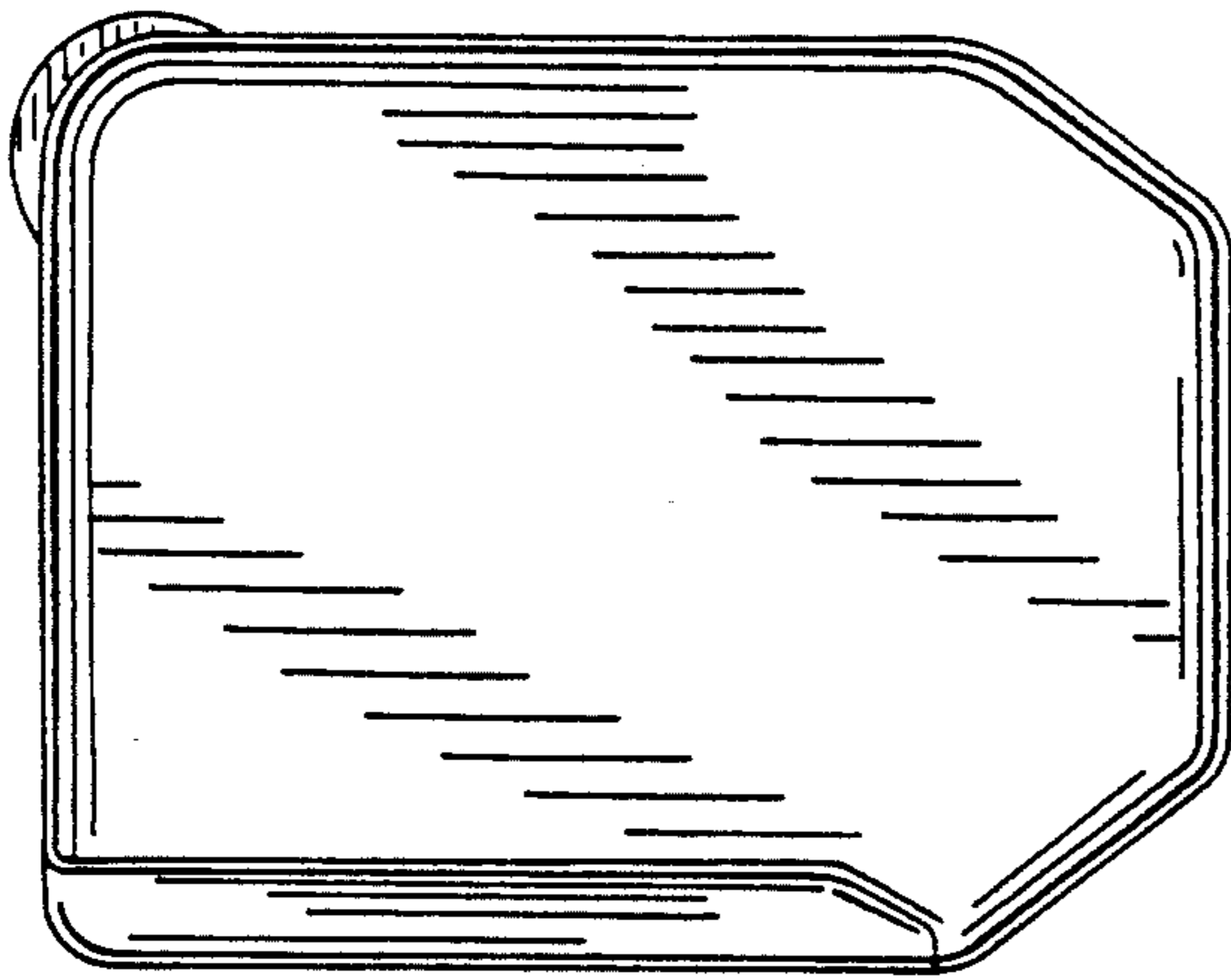

FIG. 1

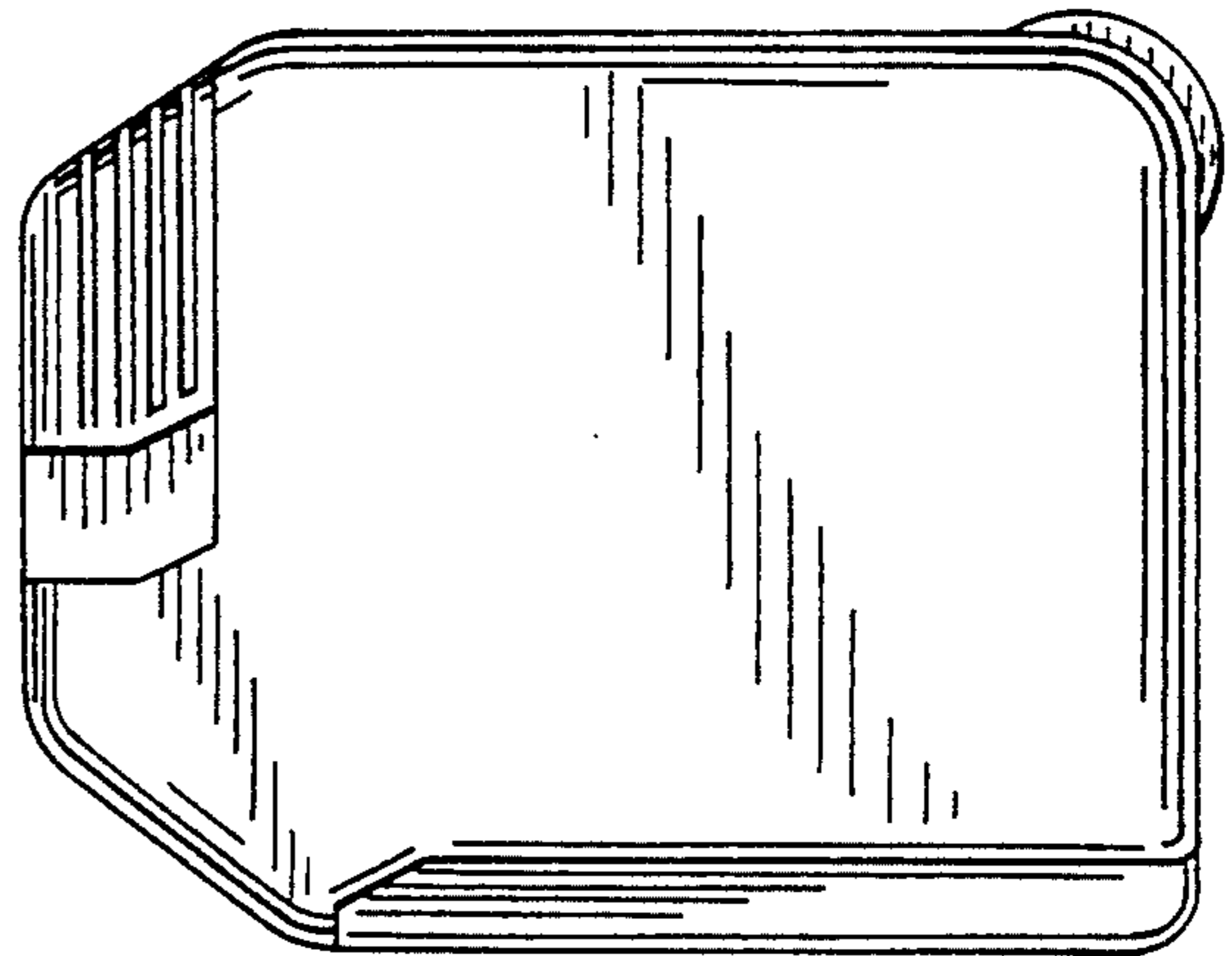

FIG. 2

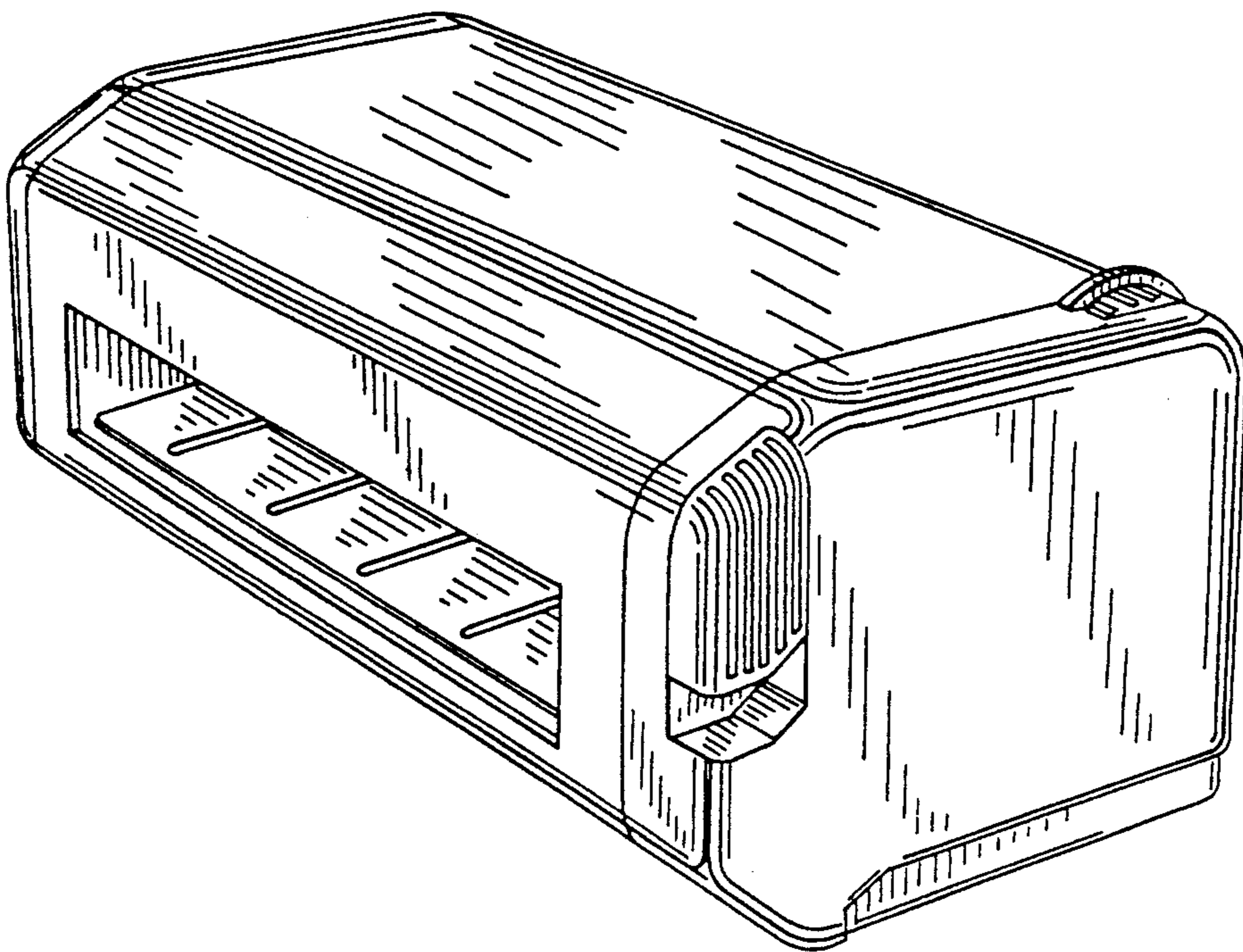

FIG. 3

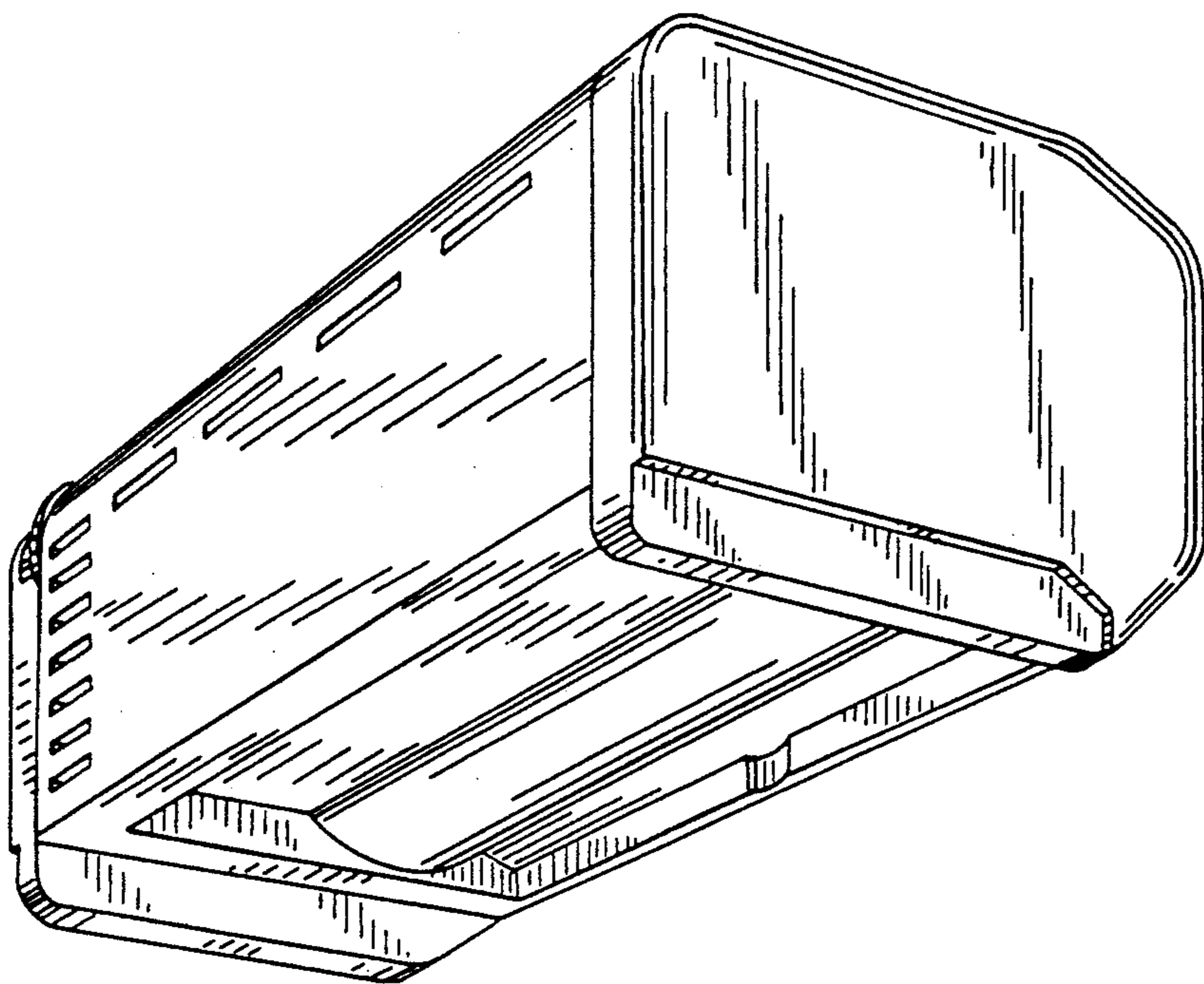

FIG. 4

FIG. 5

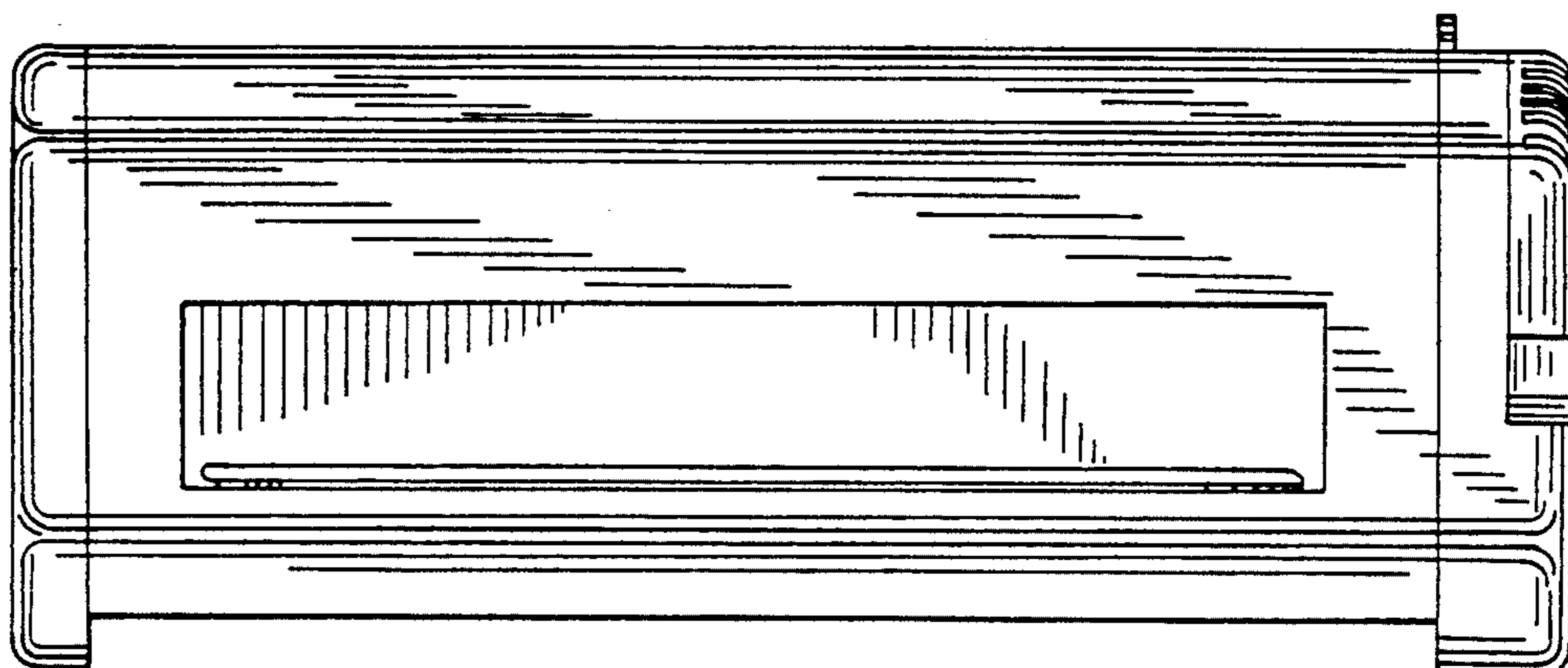
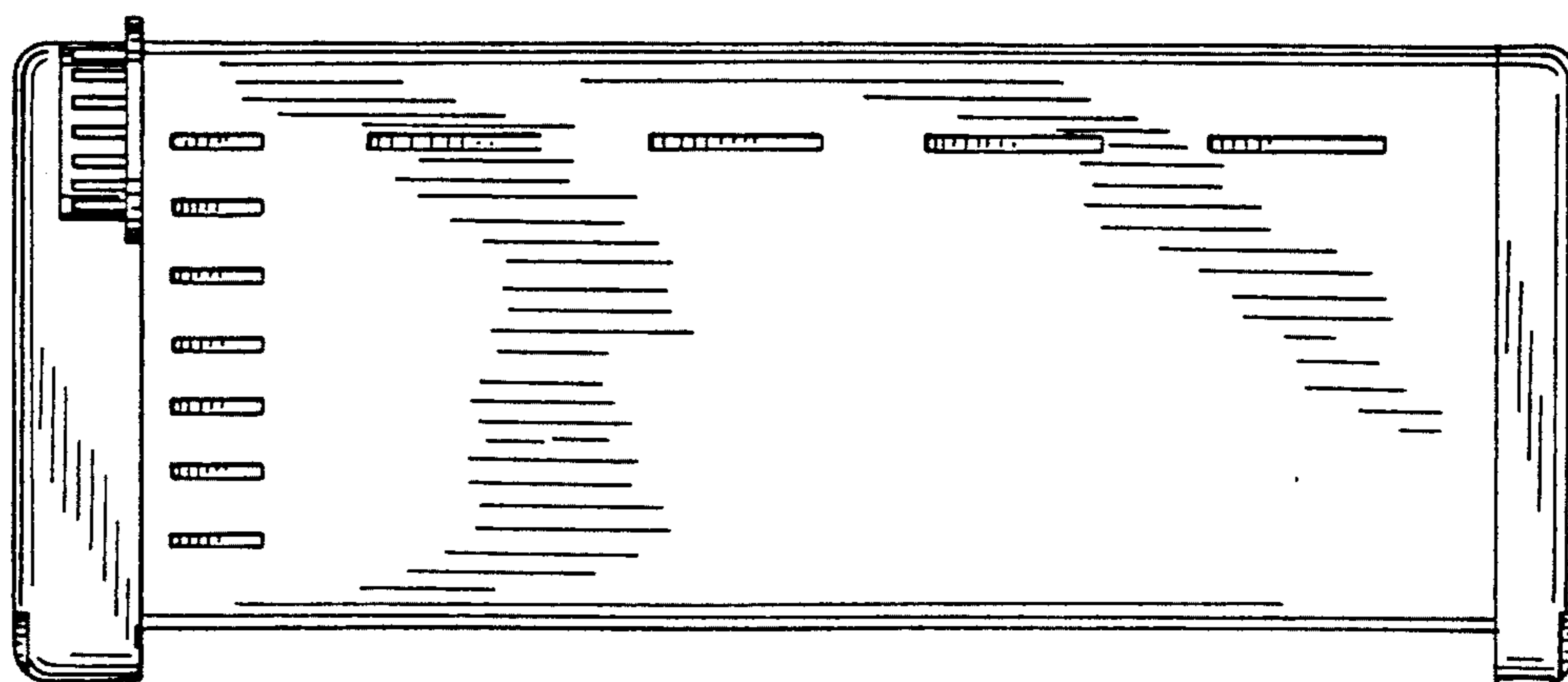

FIG. 6



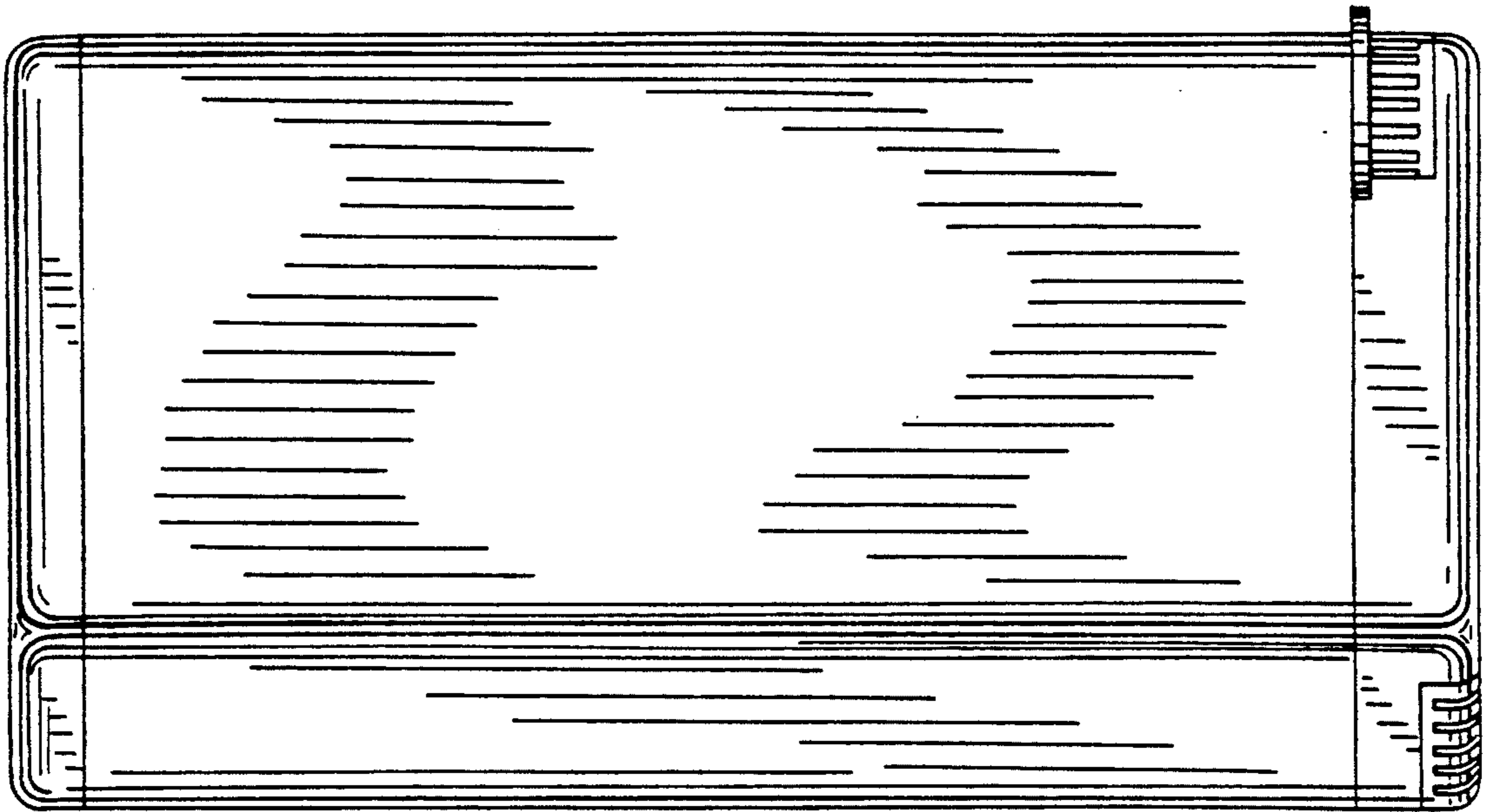

FIG. 7

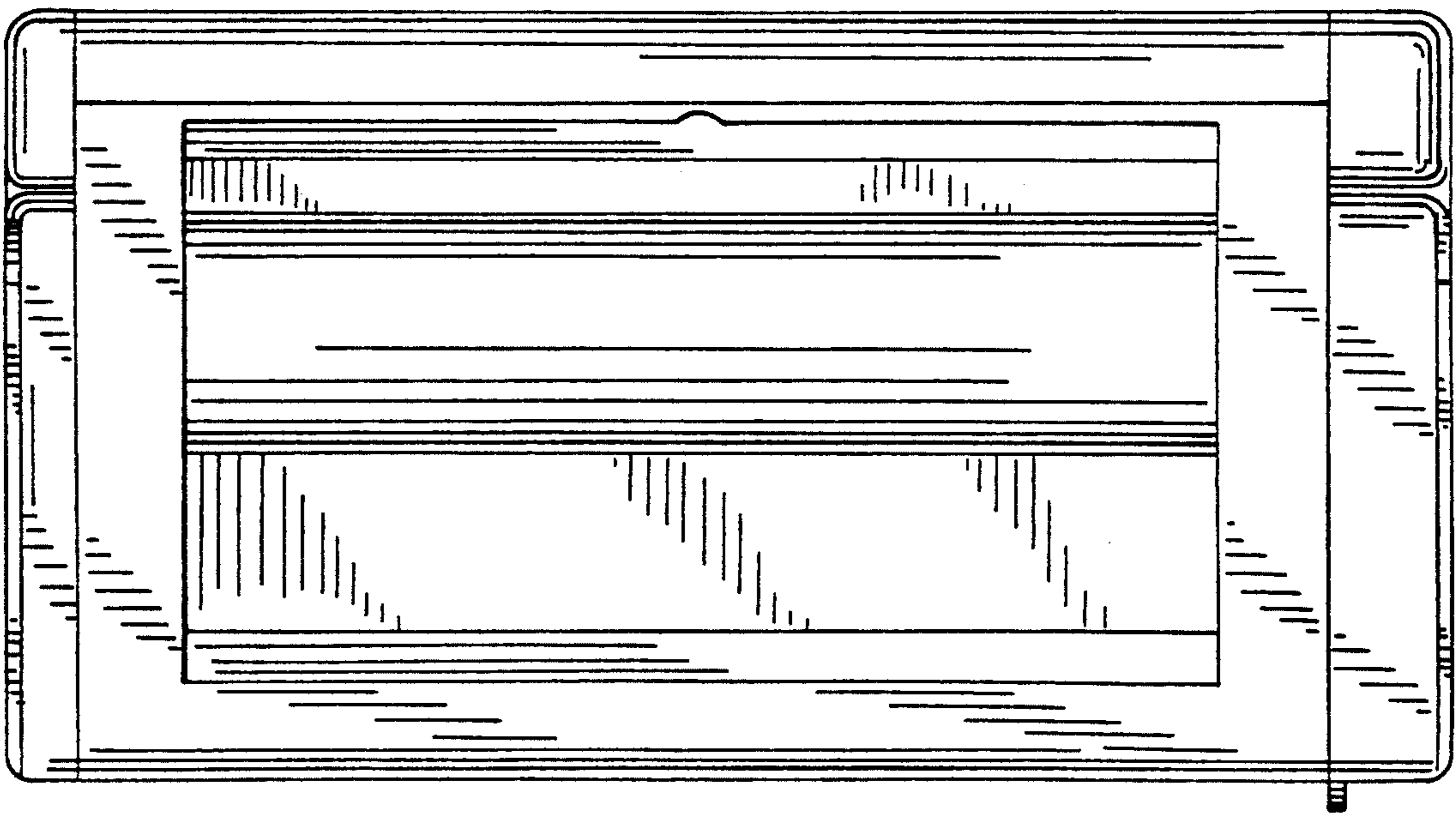

FIG. 8