



US00D347720S

United States Patent [19]

[11] Patent Number: **Des. 347,720**

Tamura et al.

[45] Date of Patent: **** Jun. 7, 1994**

[54] **COMPACT VEHICLE WITH VERTICALLY MOVABLE PLATFORM**

D. 241,024 8/1976 Lantz D34/34
3,101,152 8/1963 Whitmore et al. D34/34
4,921,385 5/1990 Okuno 254/2 R

[75] Inventors: **Hideaki Tamura, Shiraoka; Yoshihiko Sakuma, Okegawa, both of Japan**

FOREIGN PATENT DOCUMENTS

2614007 10/1977 Fed. Rep. of Germany 254/2 R
61-31891 9/1986 Japan 280/43.12

[73] Assignee: **Kabushiki Kaisha Aichi Corporation, Nagoya, Japan**

Primary Examiner—Kay H. Chin
Attorney, Agent, or Firm—Robert W. J. Usher

[**] Term: **14 Years**

[57] CLAIM

[21] Appl. No.: **1,829**

The ornamental design for a compact vehicle with a vertically movable platform, as shown and described.

[22] Filed: **Nov. 23, 1992**

DESCRIPTION

[30] Foreign Application Priority Data

May 26, 1992 [JP] Japan 04-15216
[52] U.S. Cl. **D34/28; D34/34**
[58] Field of Search 254/2 R, 9 C, 93;
187/9 R, 17, 18; 182/2; 280/43.12; D34/28, 33,
34

FIG. 1 is a left side elevational view of the compact vehicle with vertically movable platform showing our new design;

FIG. 2 is a right side elevational view thereof;

FIG. 3 is a top plan view thereof;

FIG. 4 is a bottom plan view thereof;

FIG. 5 is a rear elevational view thereof;

FIG. 6 is a front elevational view thereof; and,

FIG. 7 is a left side elevational view with the extended vertical pole.

[56] References Cited

U.S. PATENT DOCUMENTS

D. 205,982 10/1966 Reimold et al. D34/33

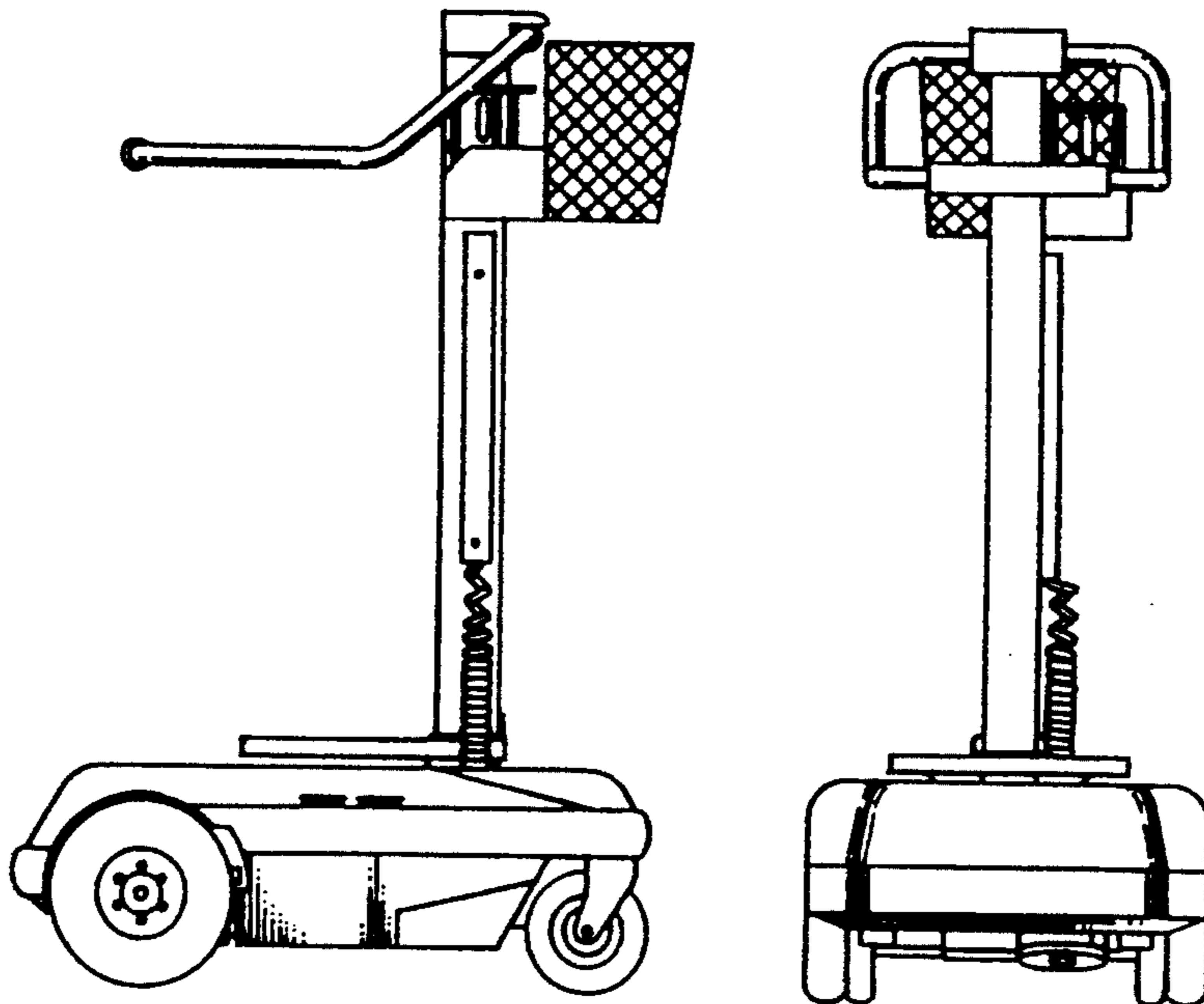

FIG. 1

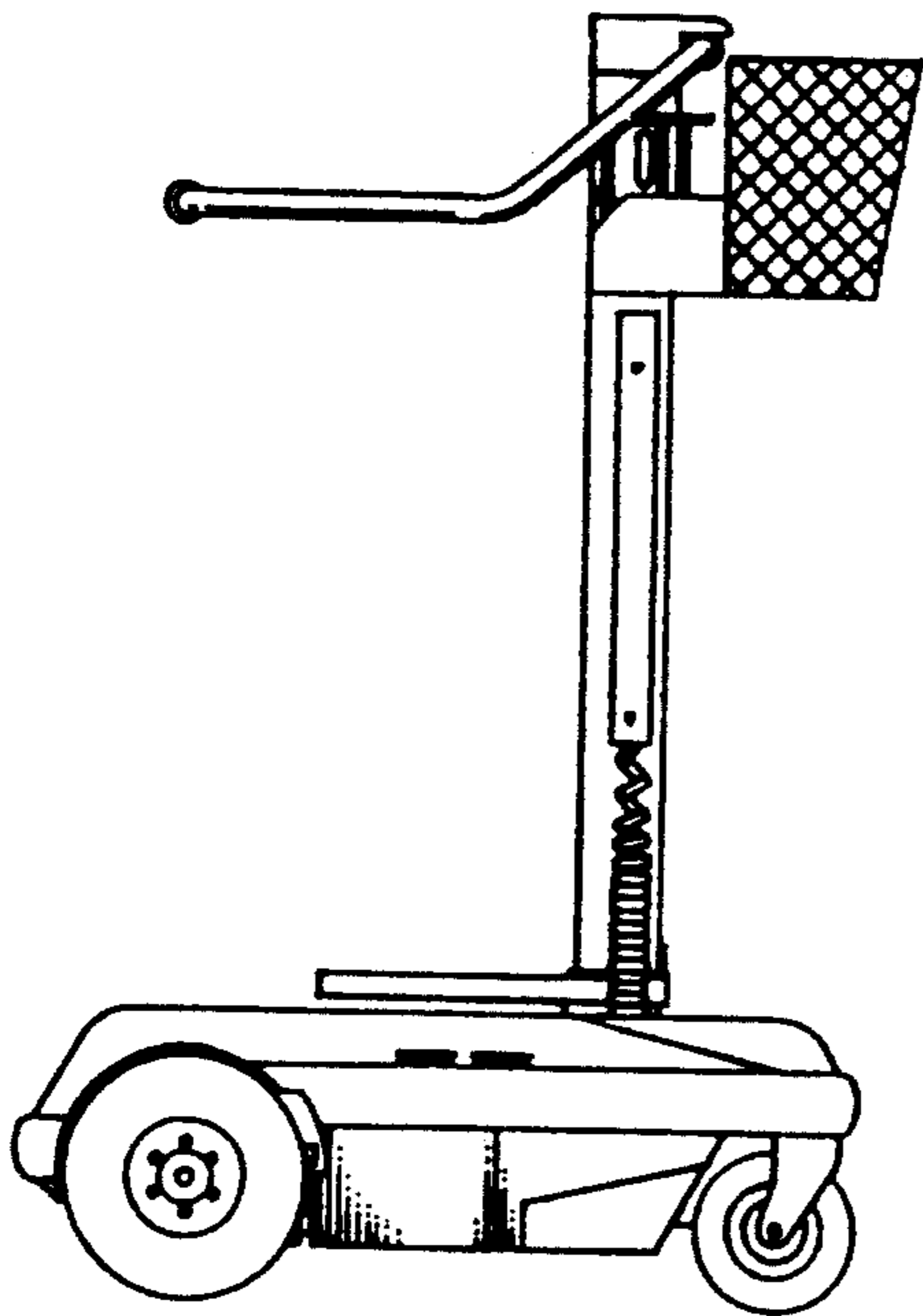

FIG. 2

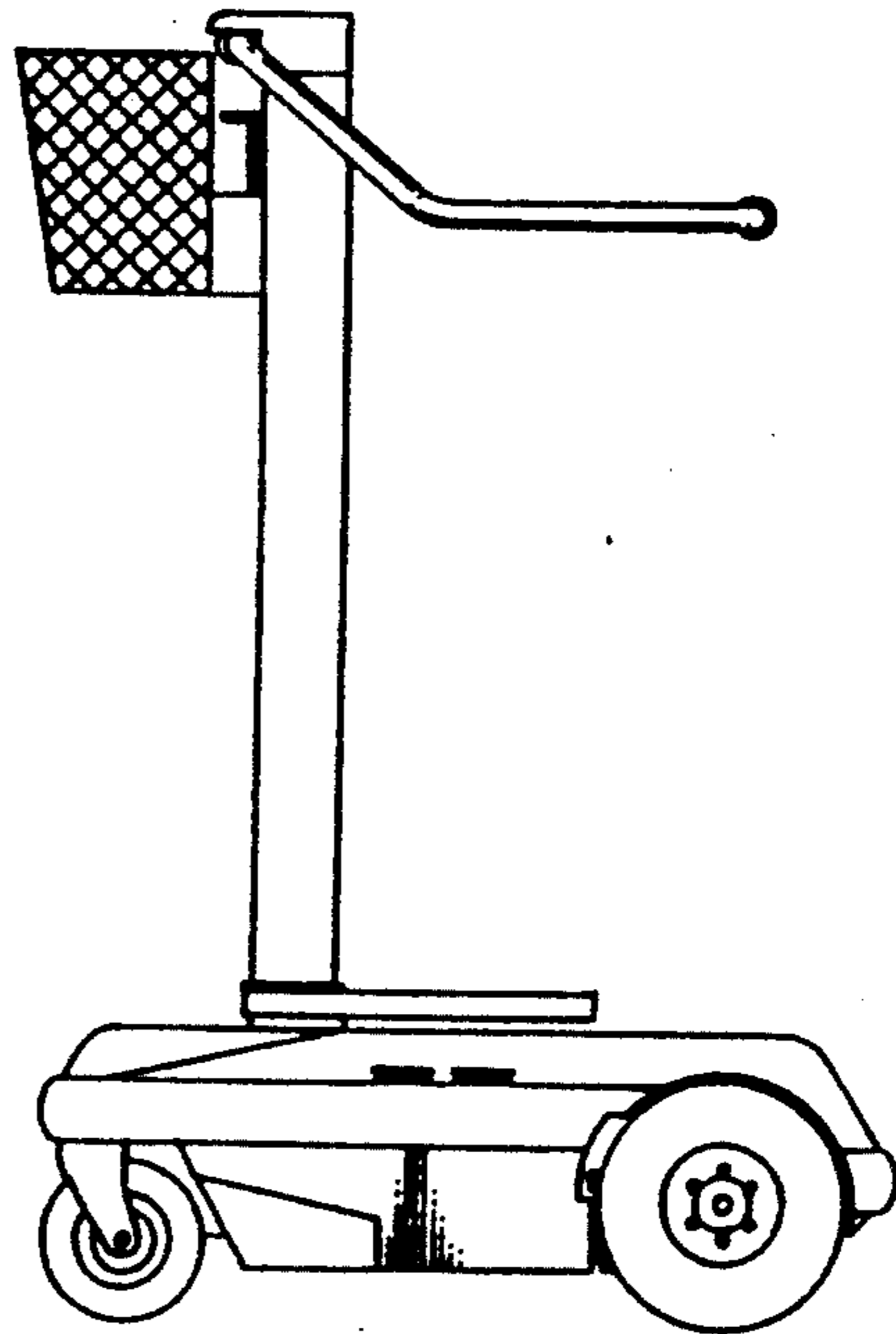

FIG. 3

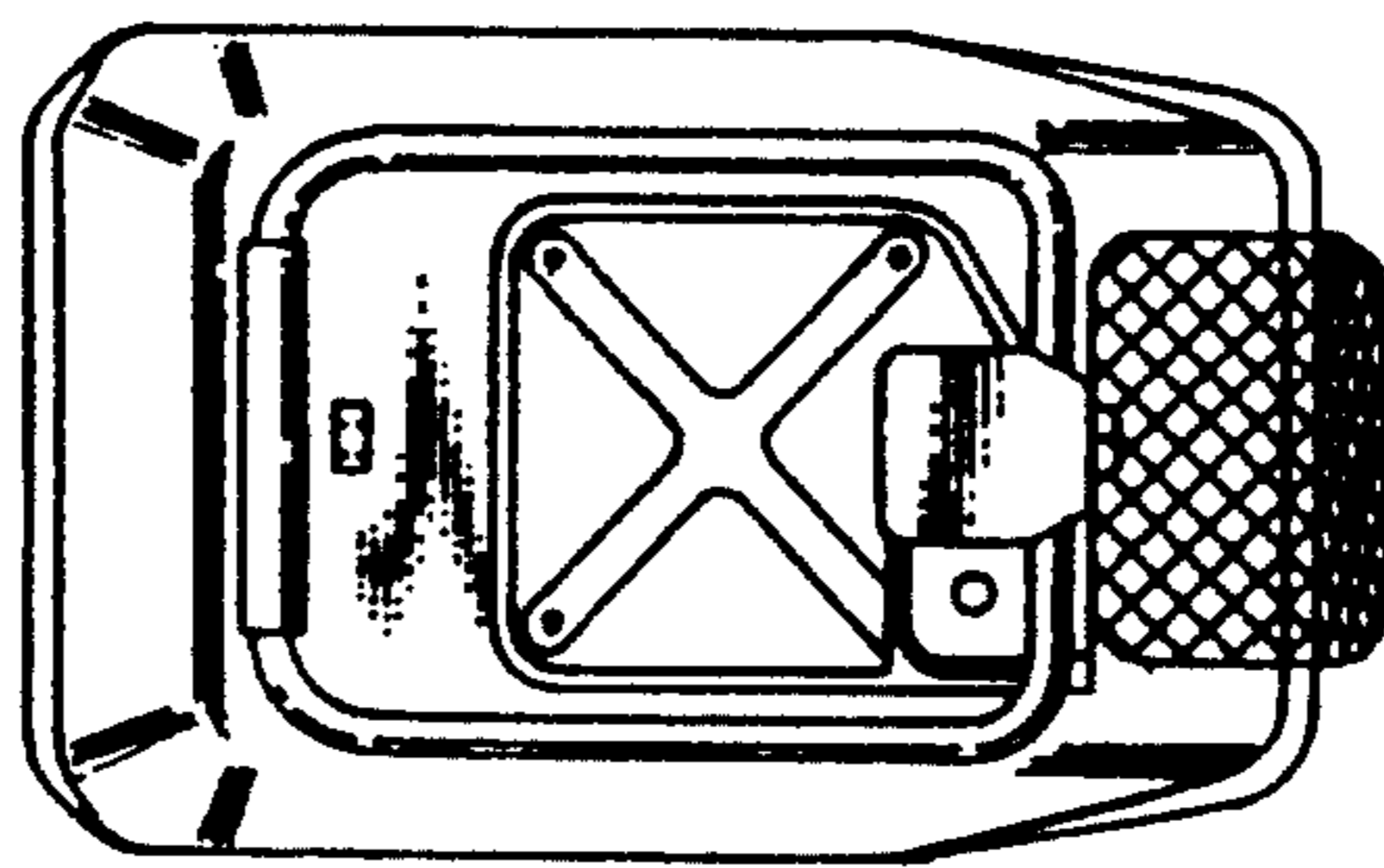

FIG. 4

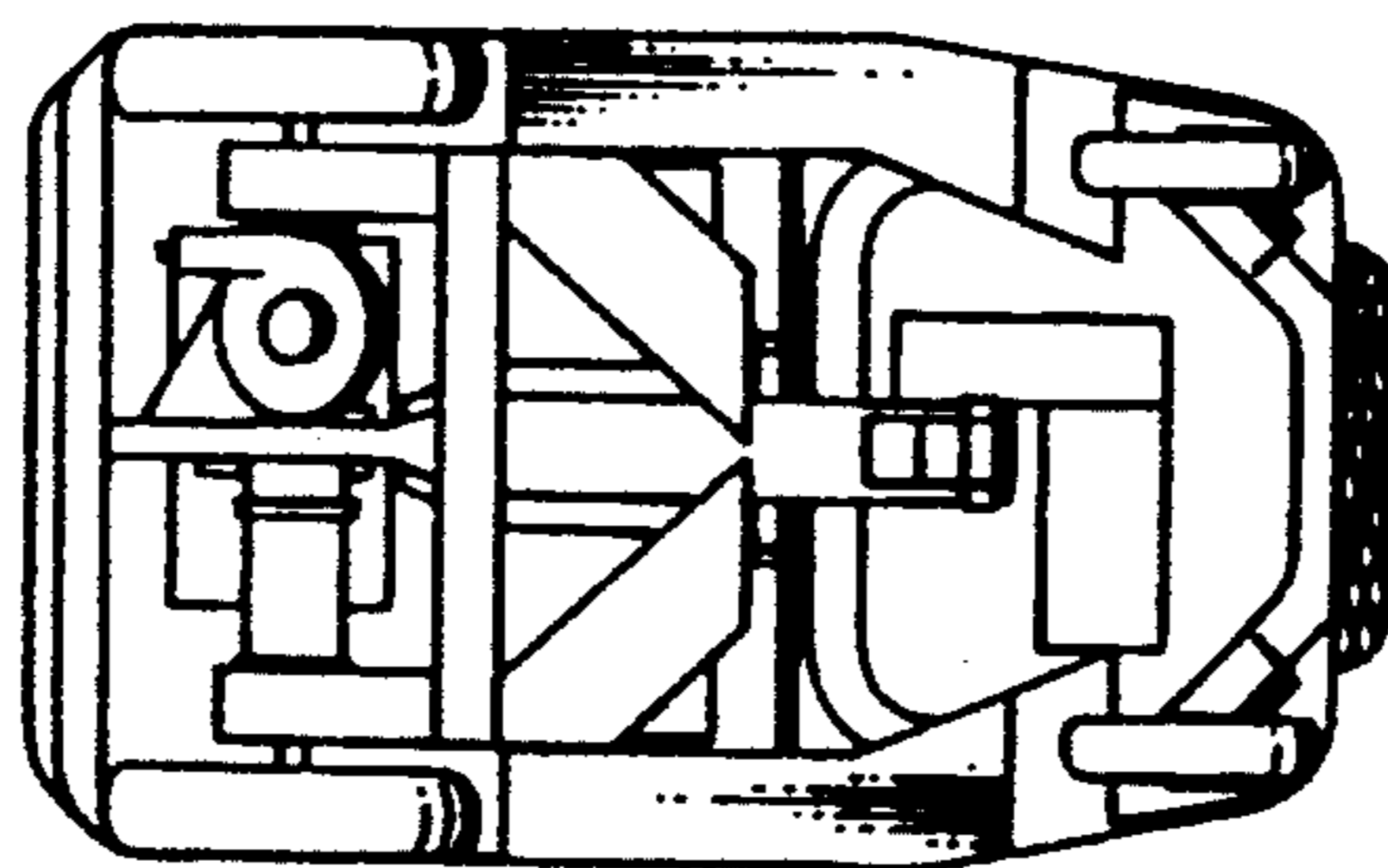

FIG. 5

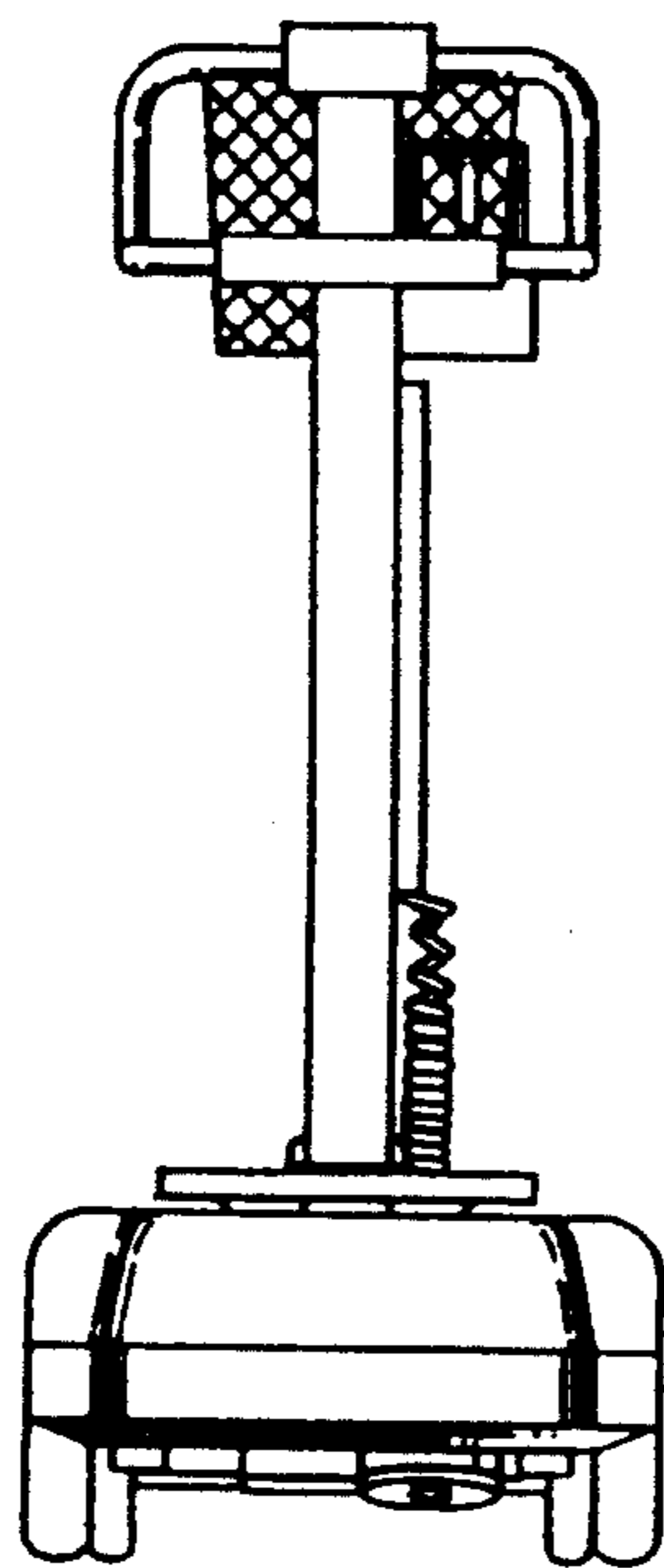

FIG. 6

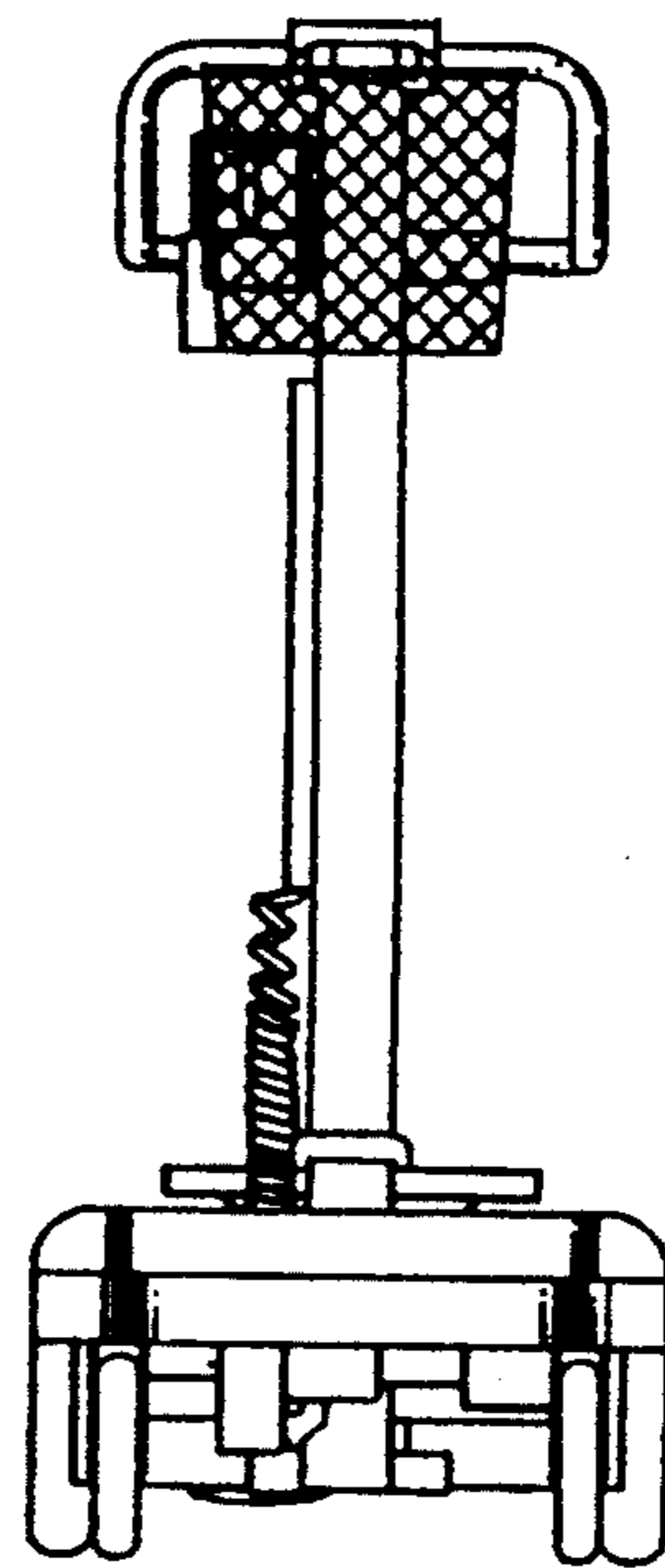

FIG. 7

