



US00D347626S

# United States Patent [19]

[11] Patent Number: **Des. 347,626**

**Kreiner et al.**

[45] Date of Patent: **\*\* Jun. 7, 1994**

## [54] PORTABLE COMPUTER

[75] Inventors: **Thomas C. Kreiner, Spring; Thomas Mitchell, Houston; Kevin W. Mundt, Spring, all of Tex.**

[73] Assignee: **Compaq Computer Corporation, Houston, Tex.**

[\*\*] Term: **14 Years**

[21] Appl. No.: **774,113**

[22] Filed: **Oct. 7, 1991**

[52] U.S. Cl. .... **D14/106**

[58] Field of Search ..... **235/145 A, 145 R; 340/700, 706; 341/22, 23; 361/390, 394, 380; 364/708, 709.04; D14/100, 101, 106, 113, 115; D18/1, 7, 11, 12**

## [56] References Cited

### U.S. PATENT DOCUMENTS

D. 294,356	2/1988	Papajohn	.....	D14/106
D. 298,537	11/1988	Walters	.....	D14/106
D. 306,156	2/1990	Myers et al.	.....	D14/106
D. 319,222	8/1991	Mizusugi et al.	.....	D14/106
D. 326,846	6/1992	Lerude	.....	D14/106
5,157,585	10/1992	Myers	.....	D14/106 X

### OTHER PUBLICATIONS

Photograph of IBM Personal System/2 Model P75 486, (1990).

*Primary Examiner*—Wallace R. Burke

*Assistant Examiner*—Freda S. Nunn

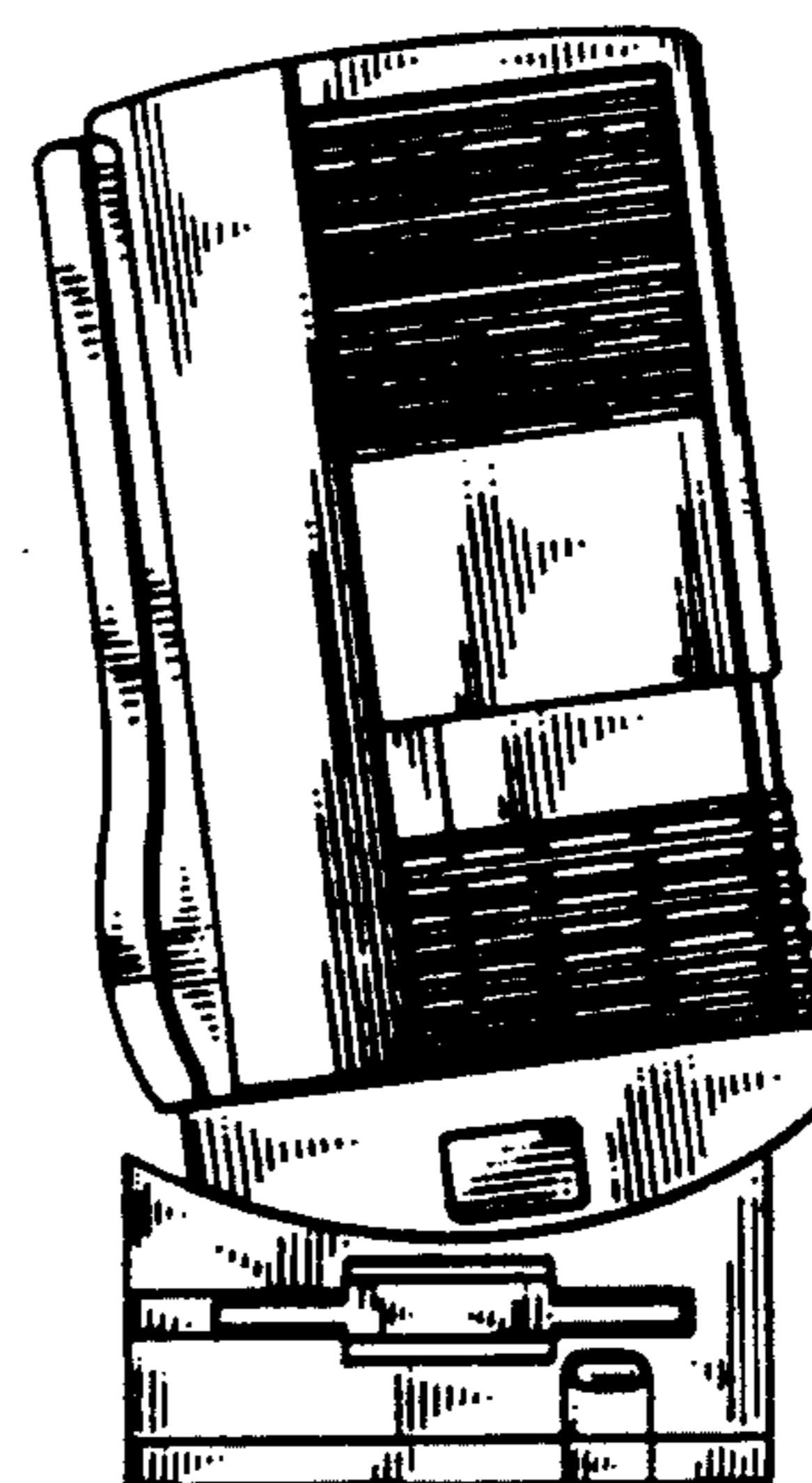
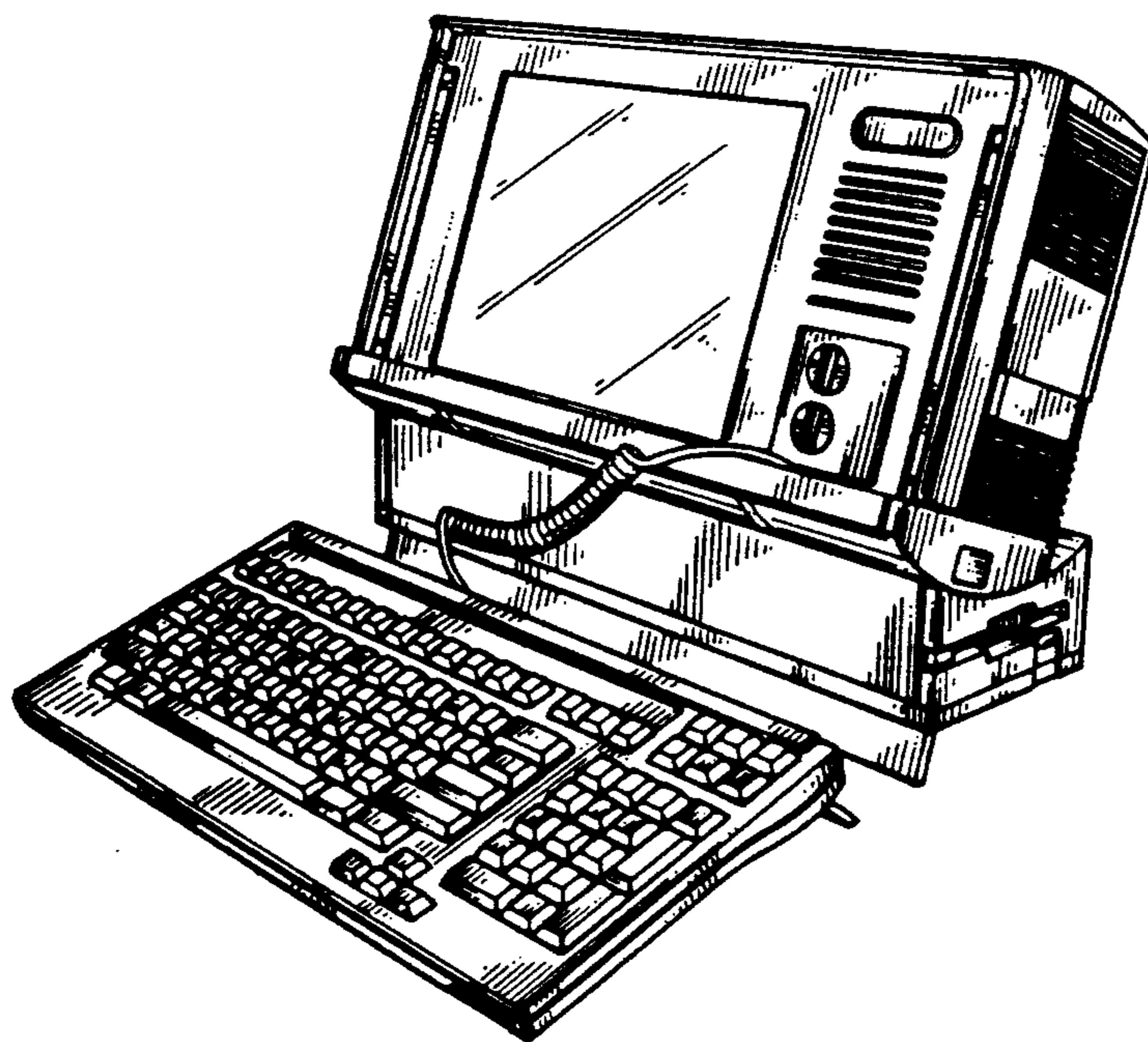
*Attorney, Agent, or Firm*—Christopher D. Keirs; L. Jon Lindsay

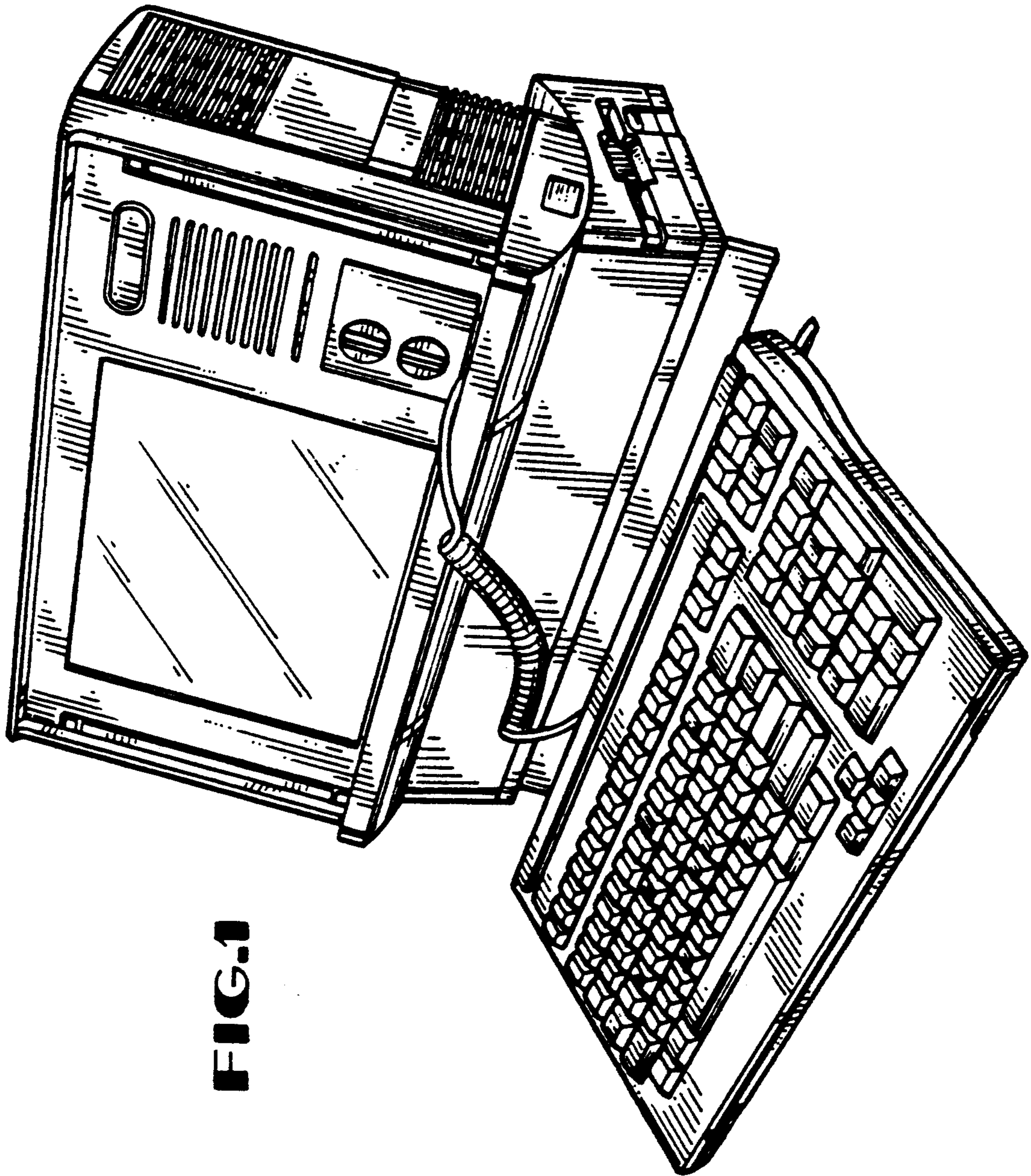
## [57] CLAIM

The ornamental design for a portable computer, as shown and described.

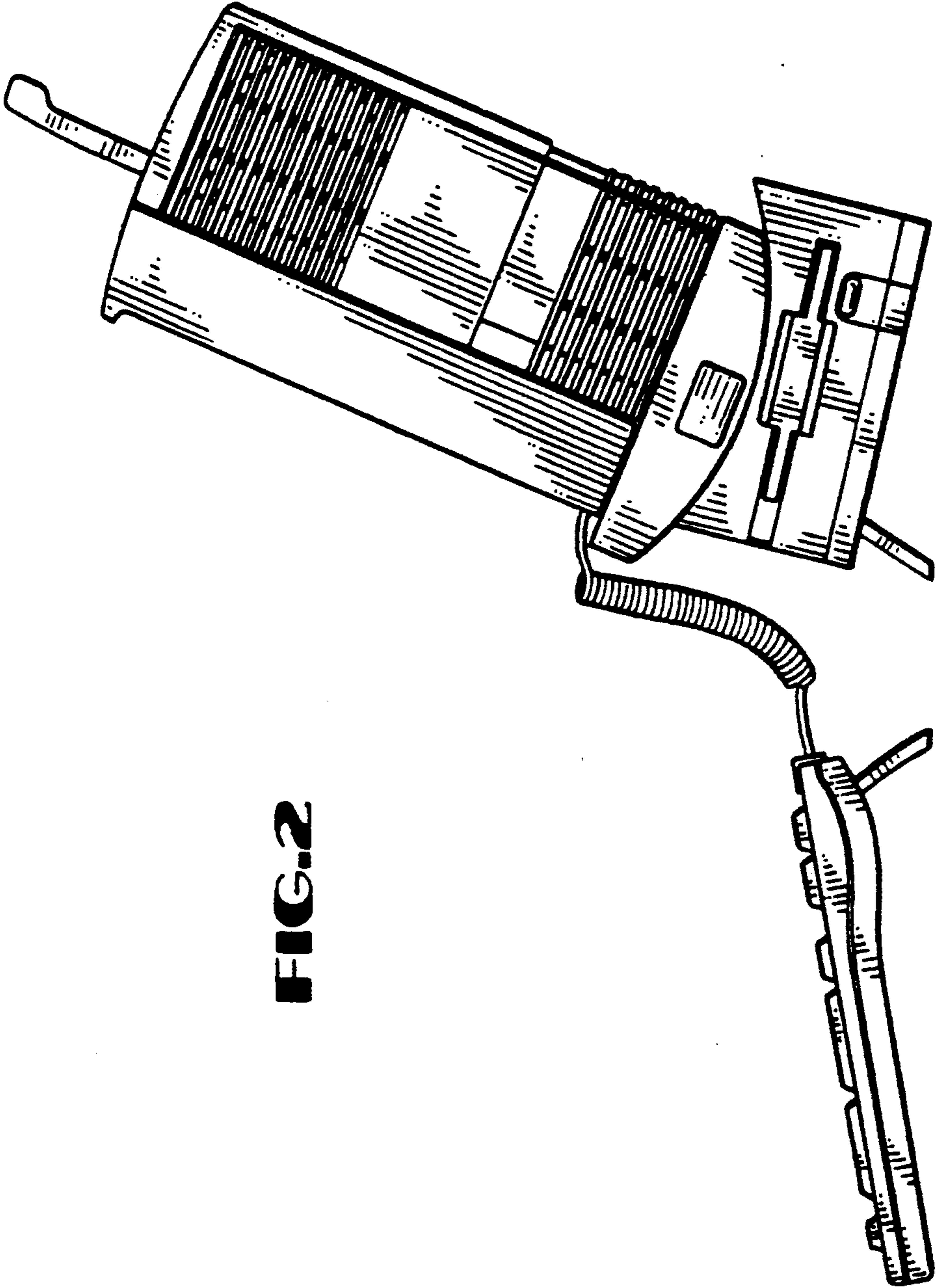
## DESCRIPTION

FIG. 1 is a top, front, left side perspective view of a portable computer showing our new design;  
 FIG. 2 is a right view thereof;  
 FIG. 3 is a top, front view thereof;  
 FIG. 4 is a top, front perspective view thereof, with the computer shown in its stowed position;  
 FIG. 5 is an enlarged right side view thereof, with the display and keyboard portions of the computer shown in their stowed position;  
 FIG. 6 is an enlarged right side view thereof, with the display portion of the computer shown in its tilted rearward position;  
 FIG. 7 is an enlarged right side view thereof, with the display portion of the computer shown in its tilted forward position;  
 FIG. 8 is a top rear perspective view thereof;  
 FIG. 9 is a top rear perspective view thereof with the handle in its carrying position;  
 FIG. 10 is an enlarged left side view thereof, with the display and keyboard portions of the computer shown in their stowed position;  
 FIG. 11 is an enlarged left side view thereof, with the display portion of the computer shown in its tilted rearward position;  
 FIG. 12 is an enlarged left side view thereof, with the display portion of the computer shown in its tilted forward position;  
 FIG. 13 is a top view thereof;  
 FIG. 14 is a bottom view thereof, with a foot portion shown in its stowed position; and,  
 FIG. 15 is a bottom view thereof, with a foot portion shown in its deployed position.

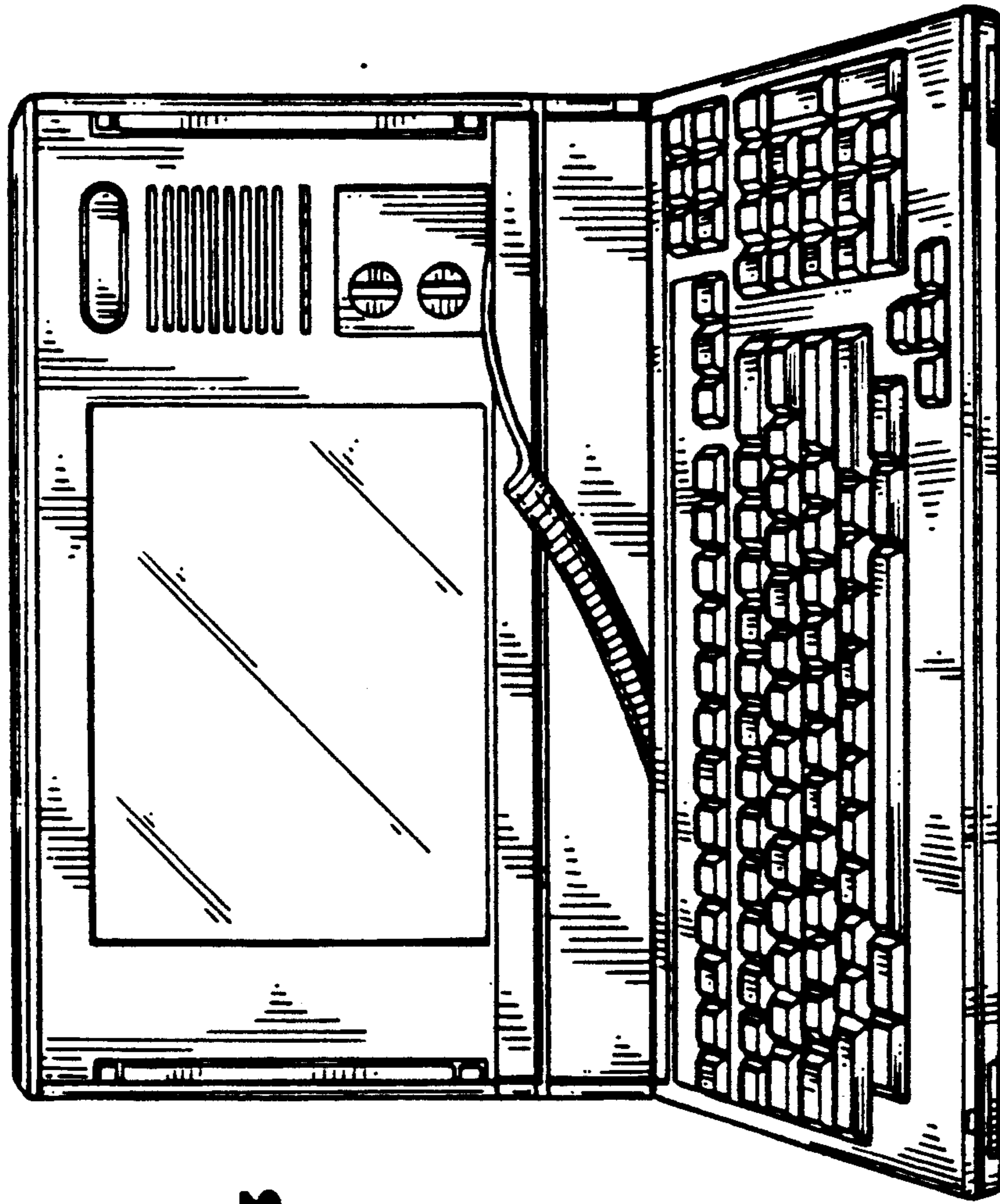




**FIG. 1**

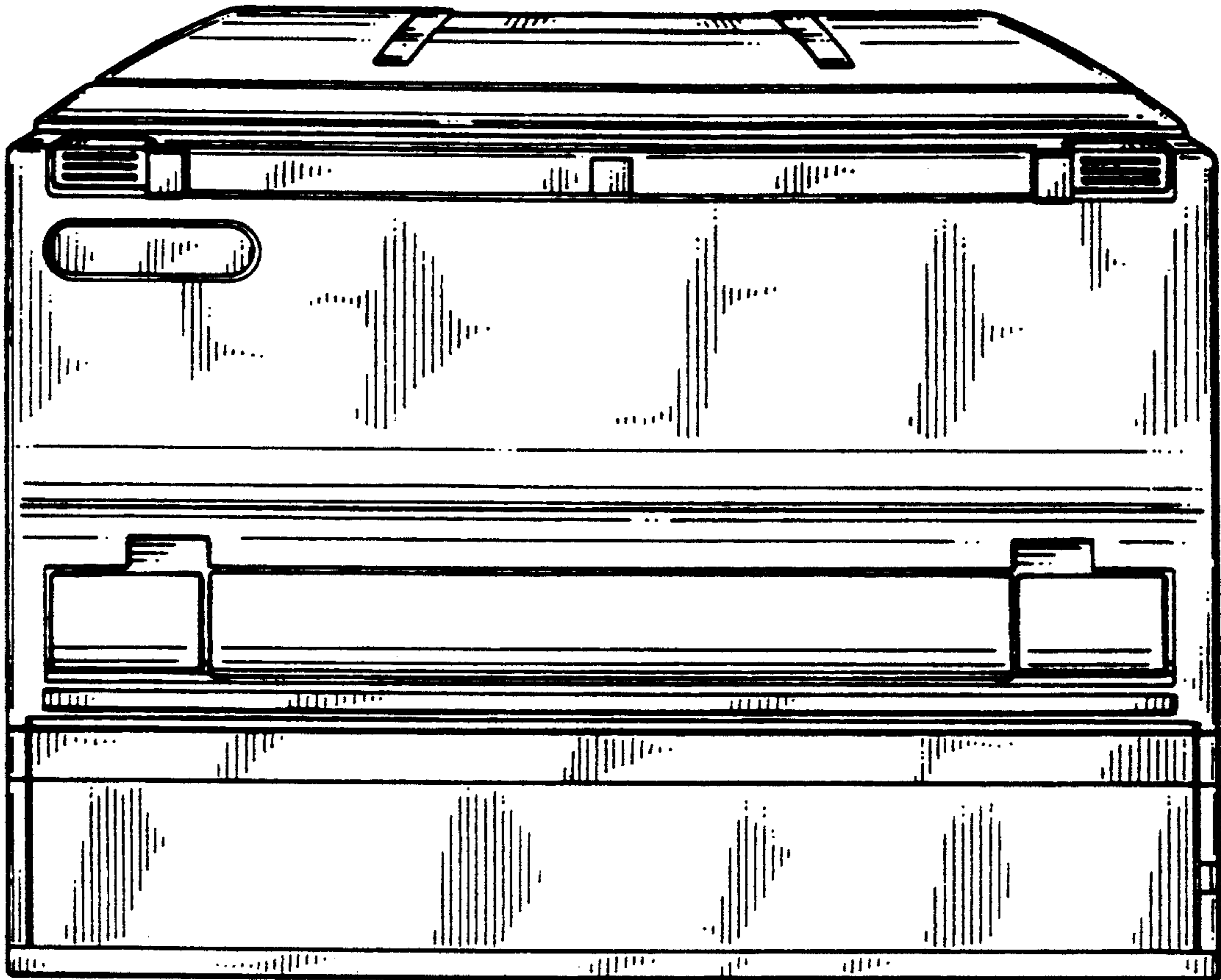


**FIG. 2**

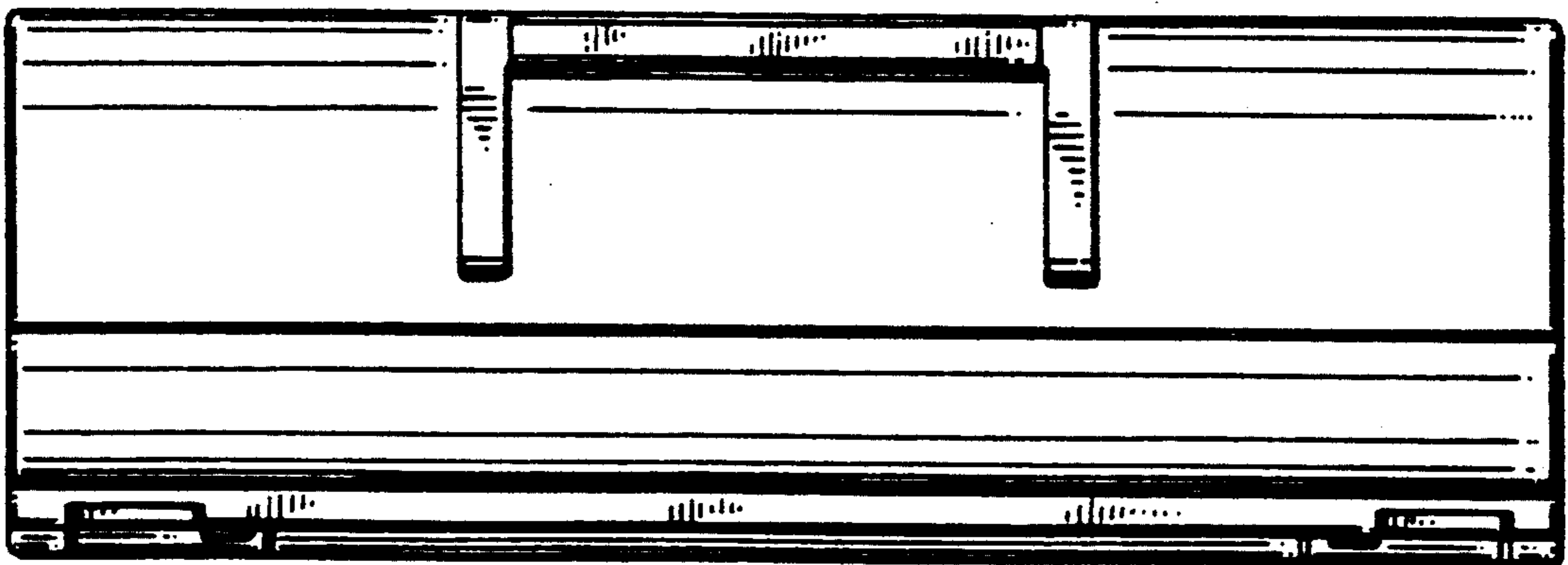


**FIG. 3**

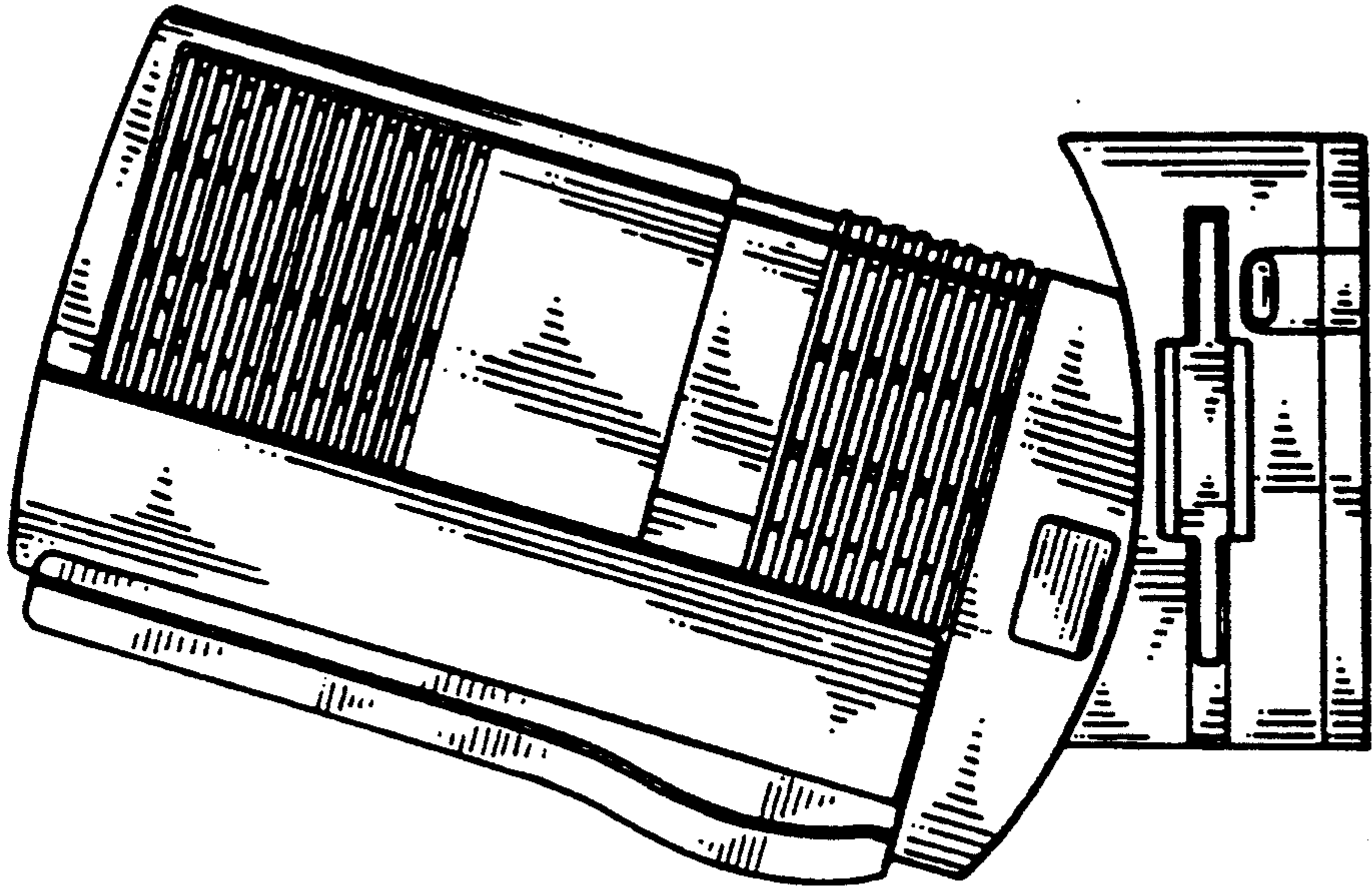
**FIG. 4**



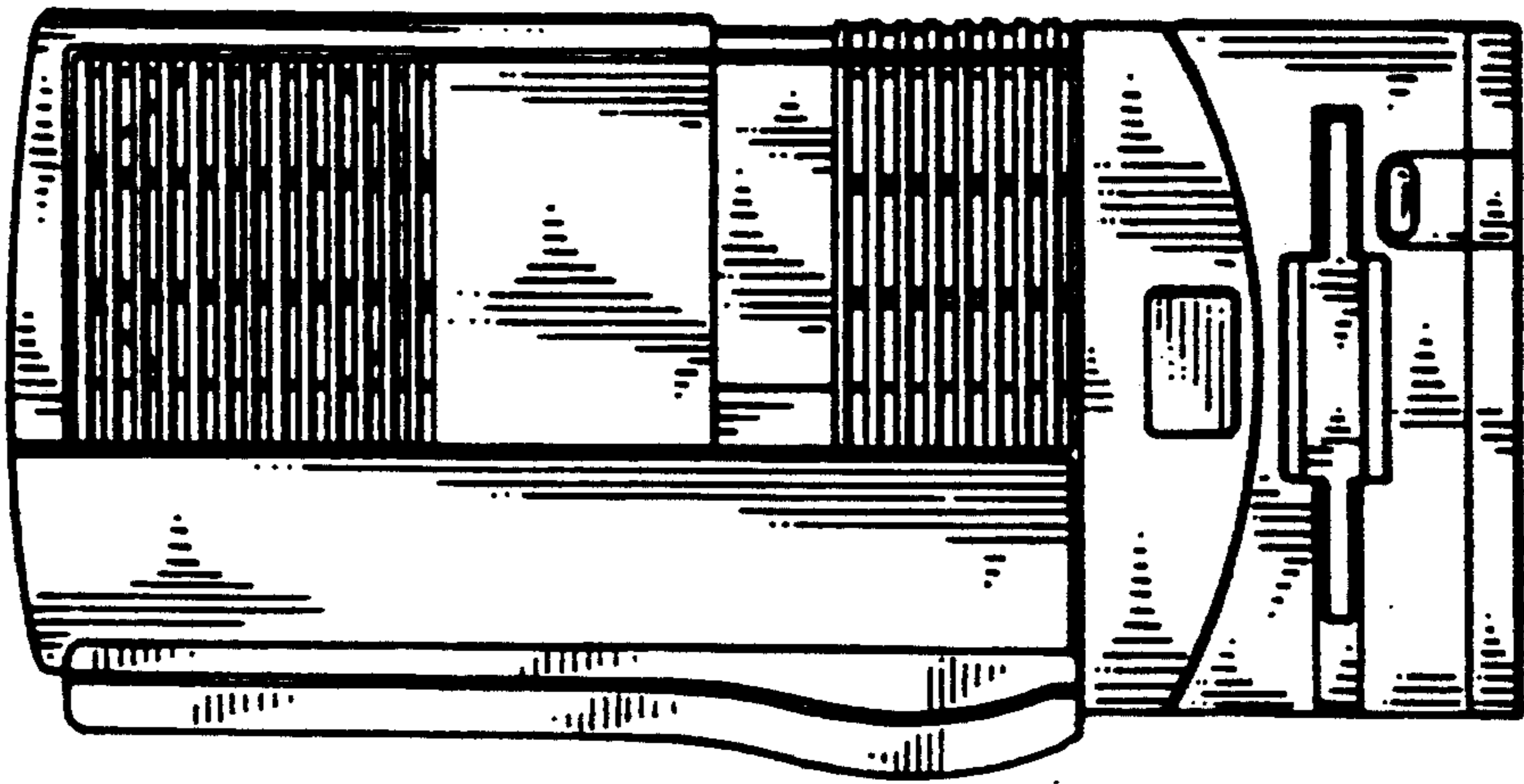
**FIG. 13**



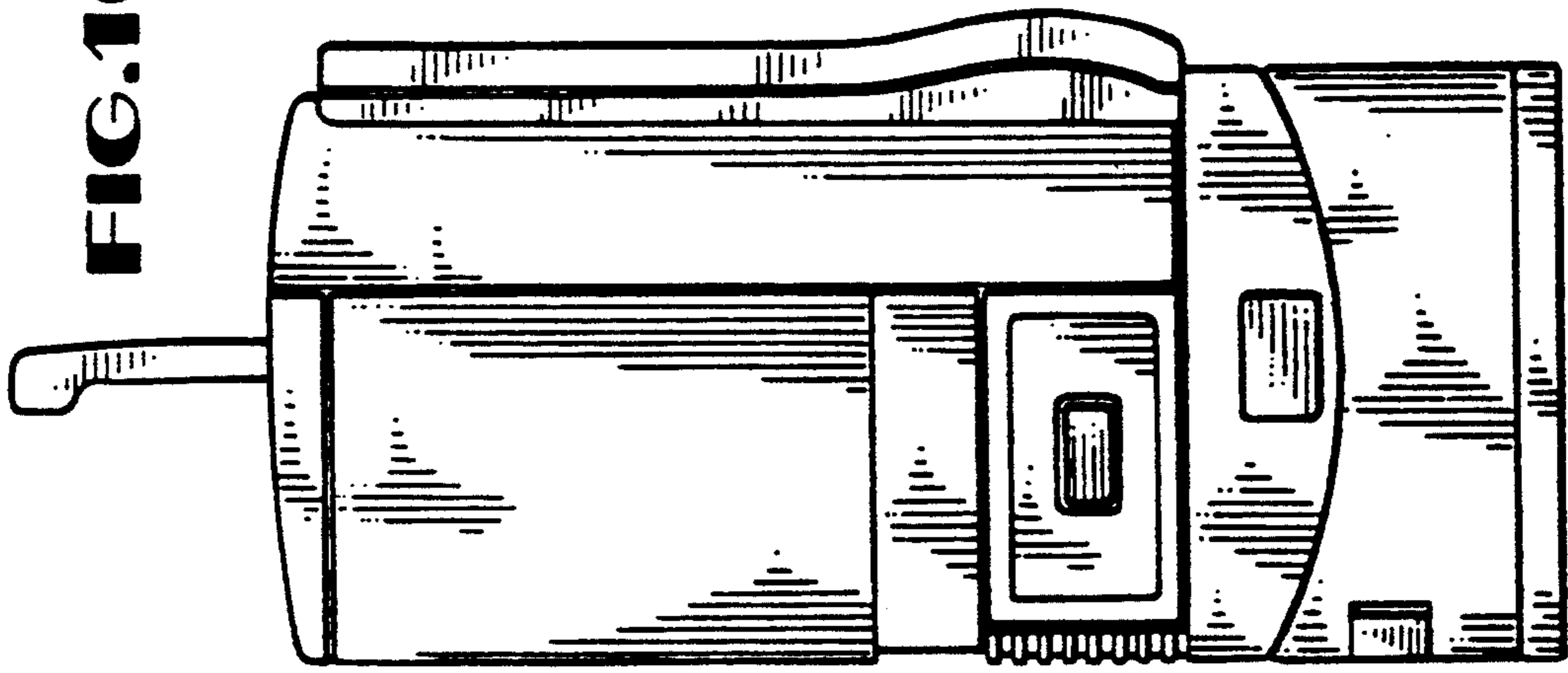
**FIG. 6**



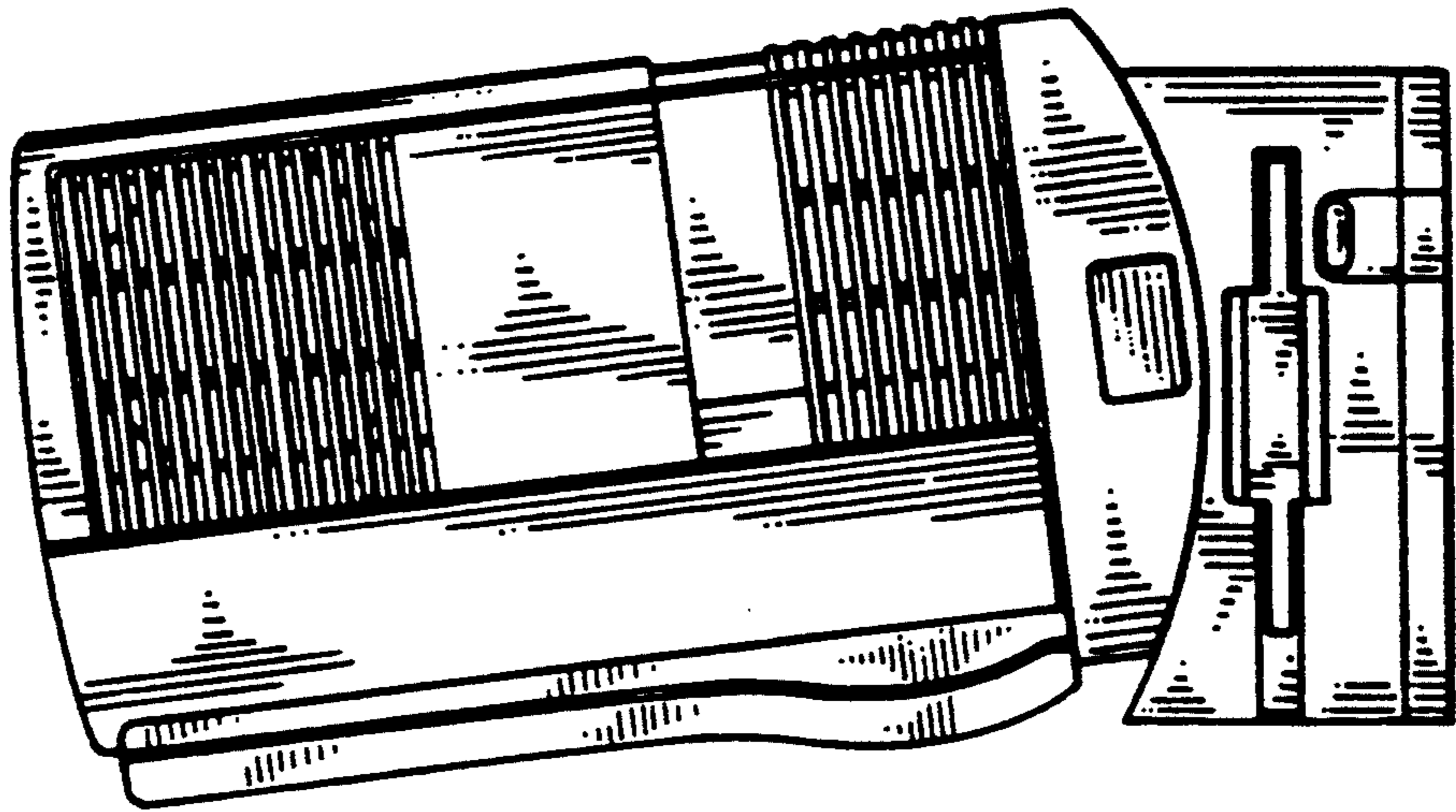
**FIG. 5**



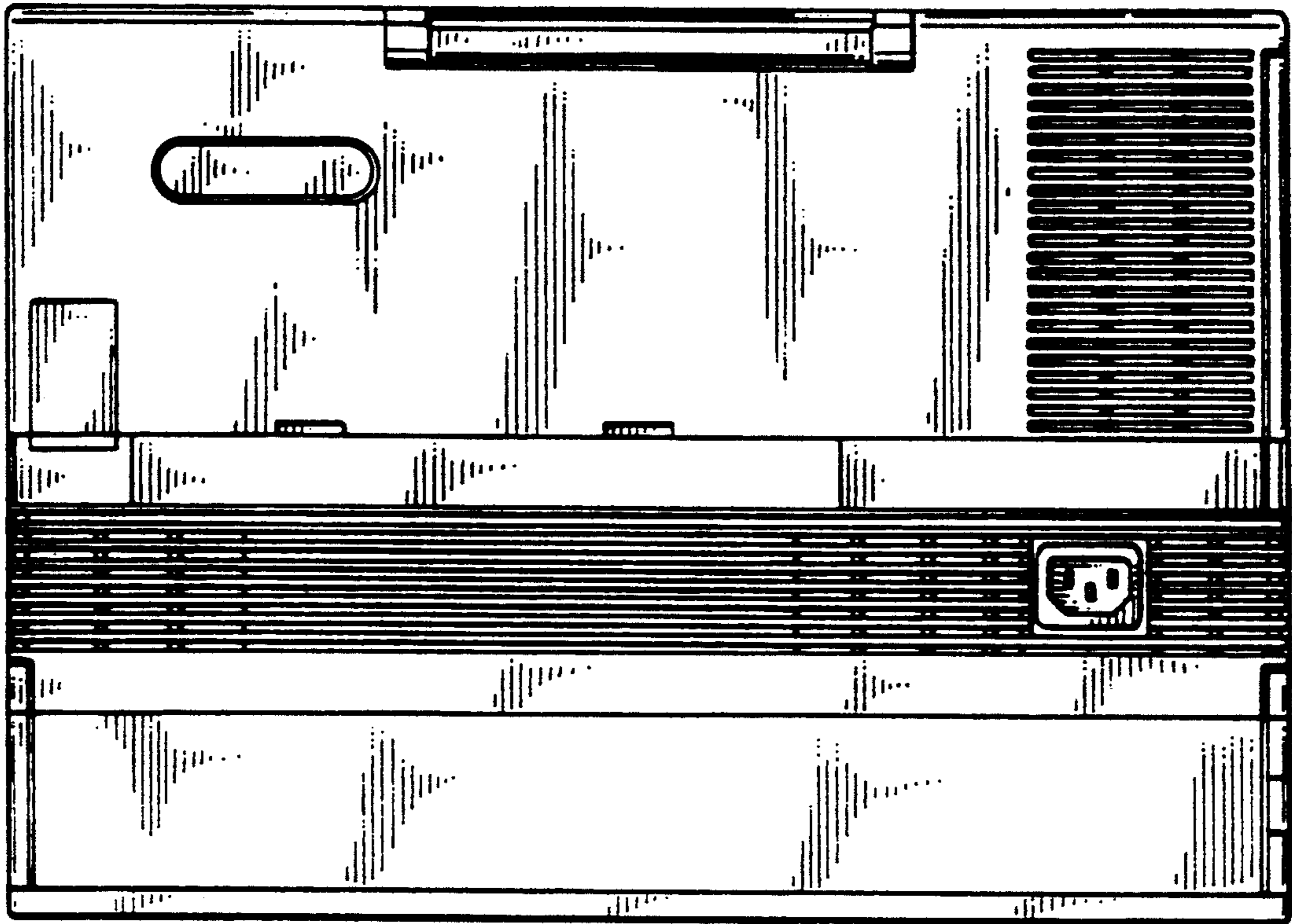
**FIG.10**



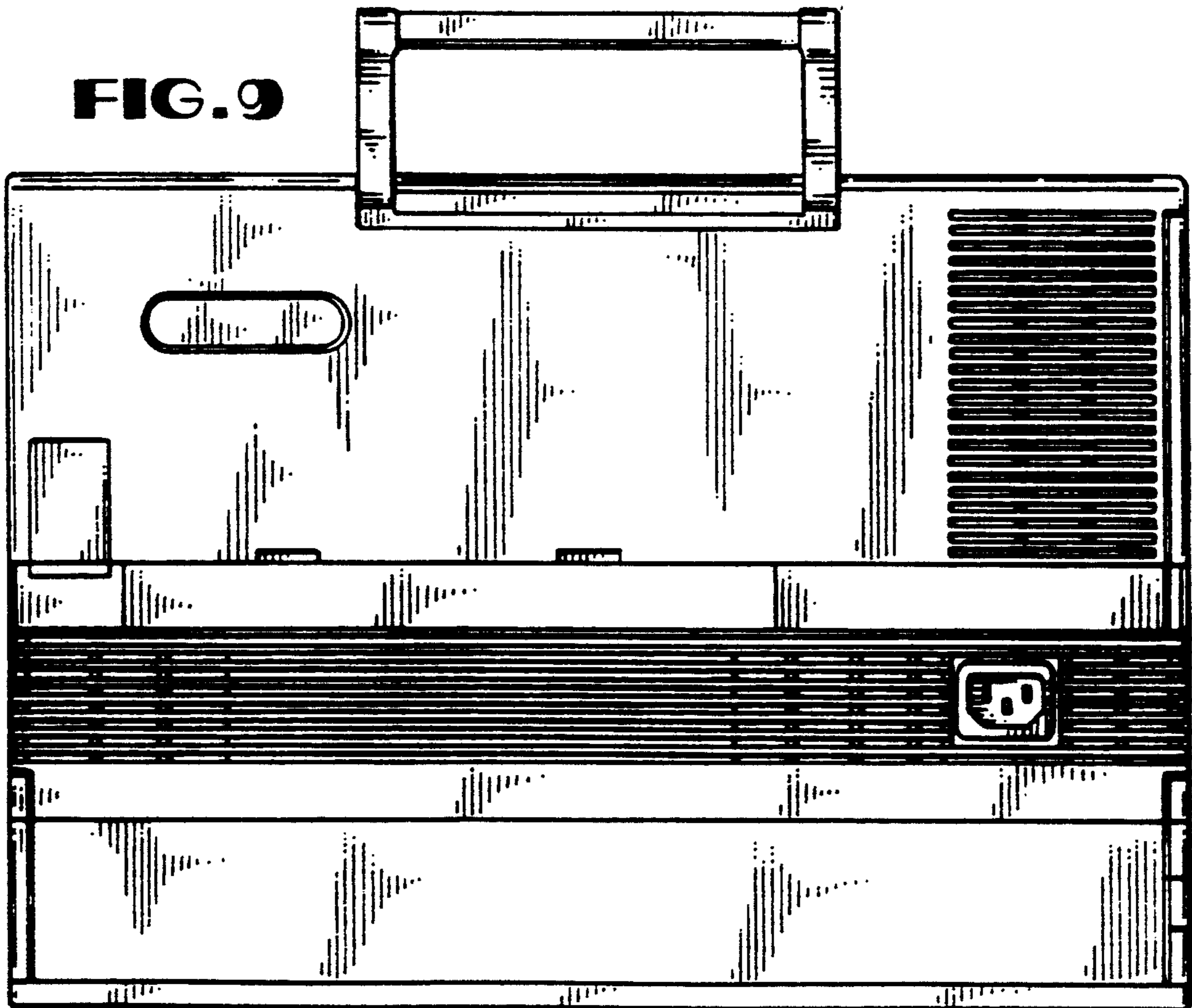
**FIG.7**



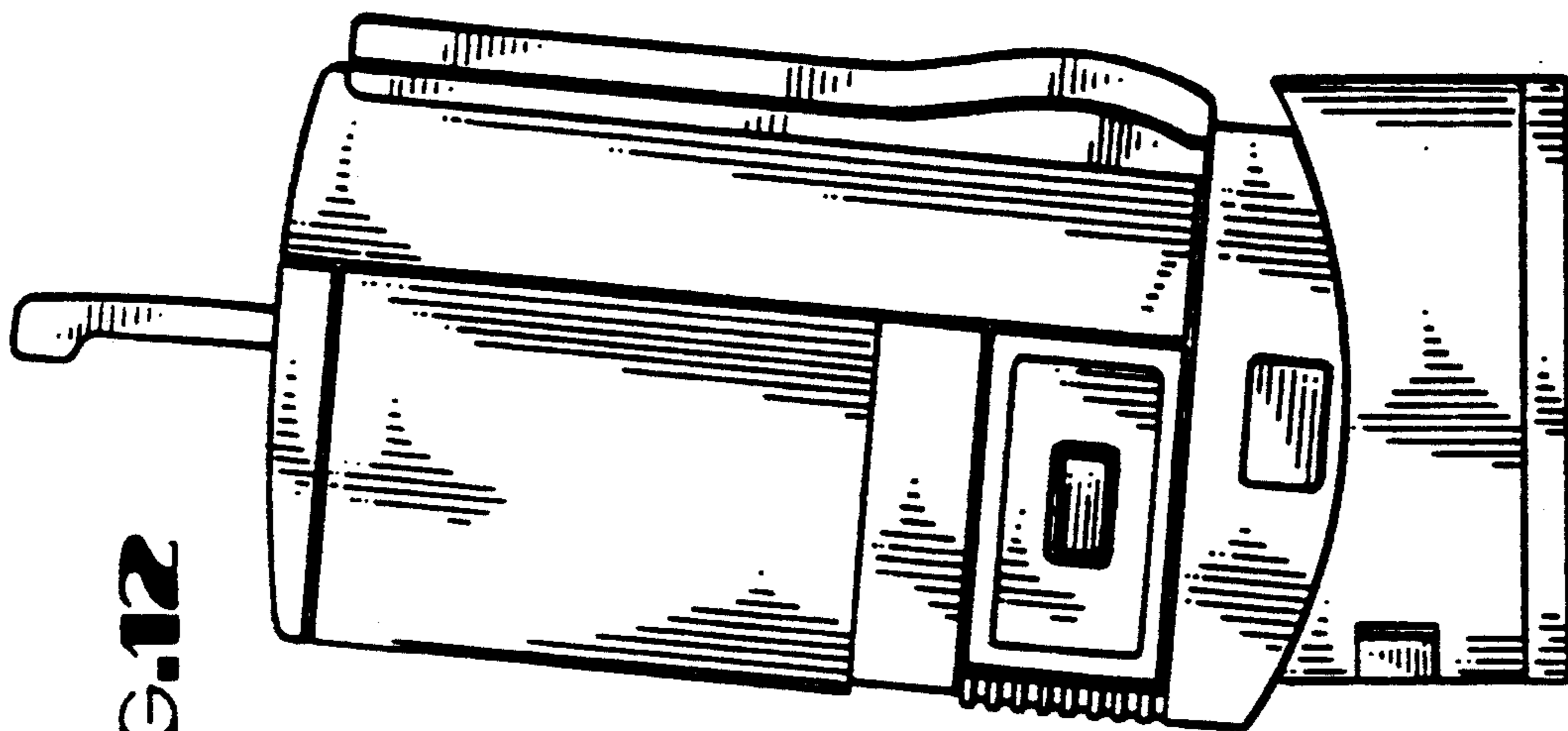
**FIG. 8**



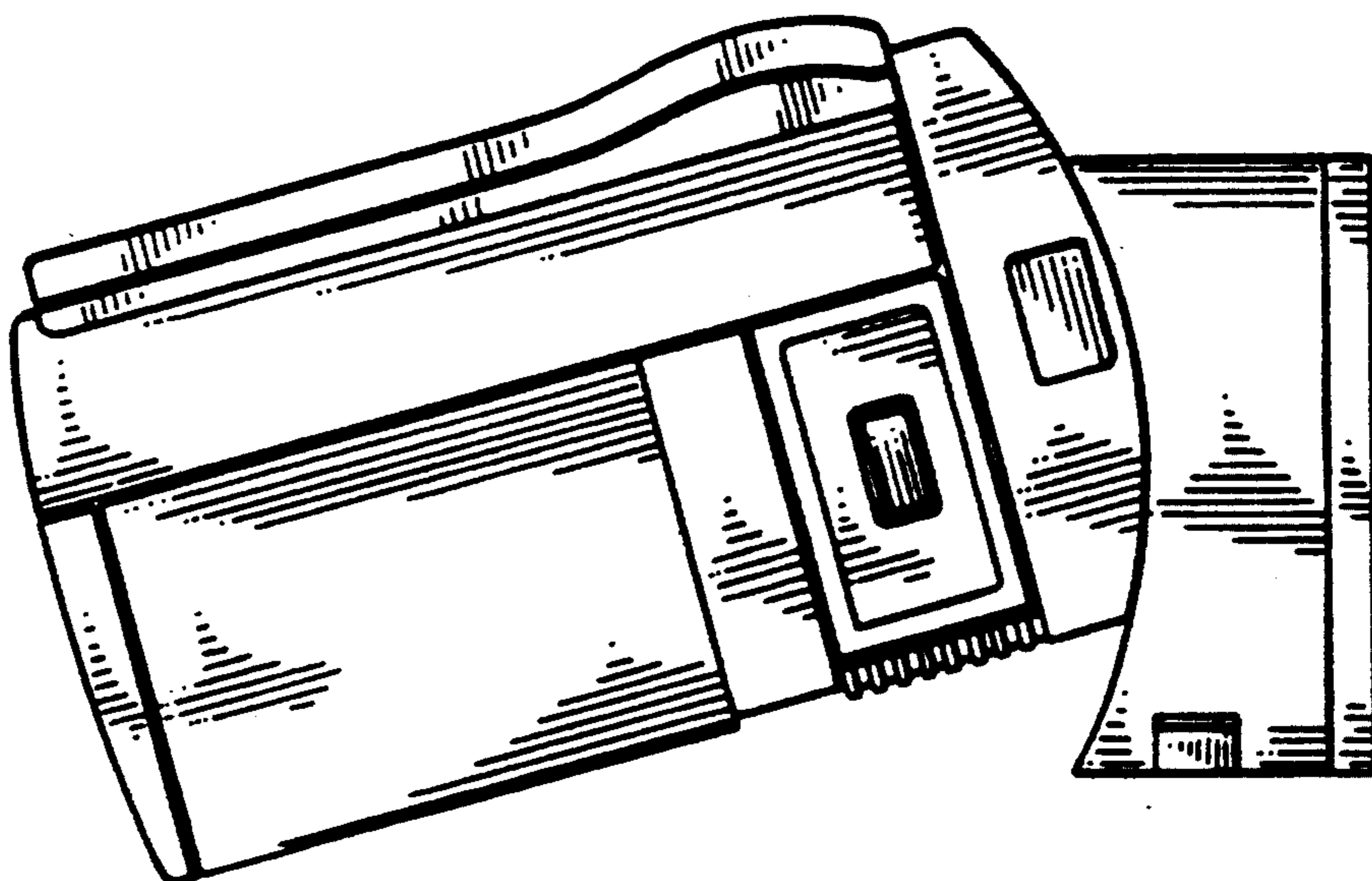
**FIG. 9**



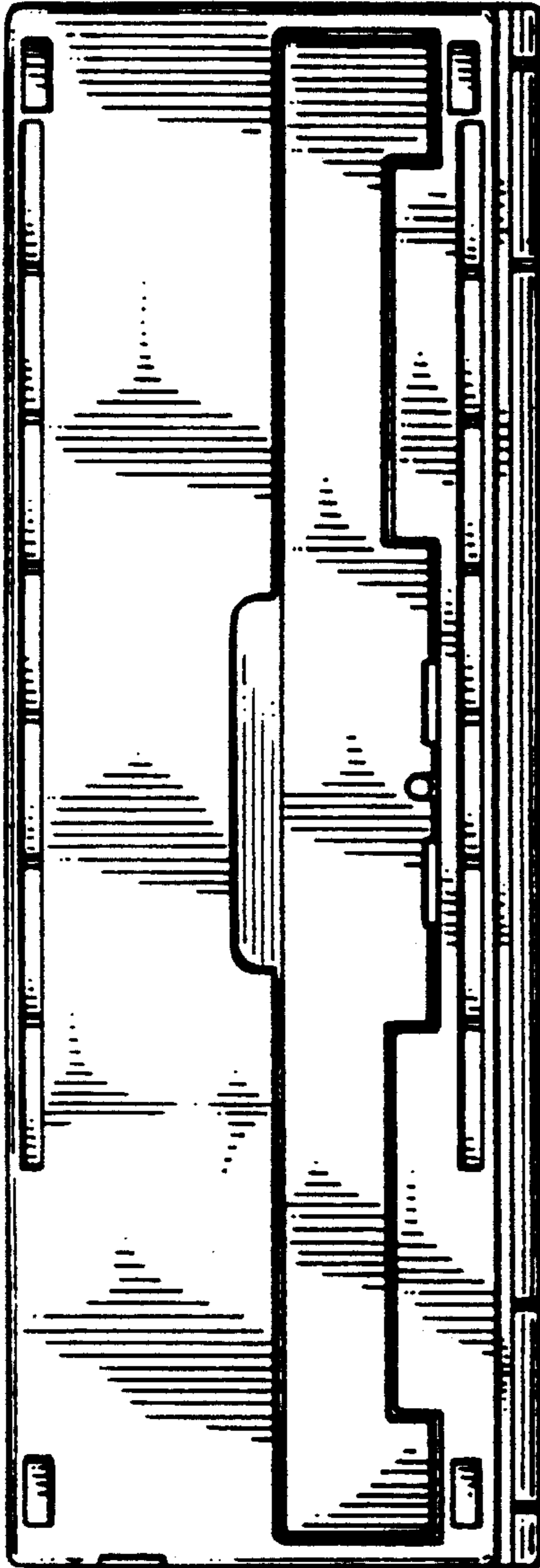




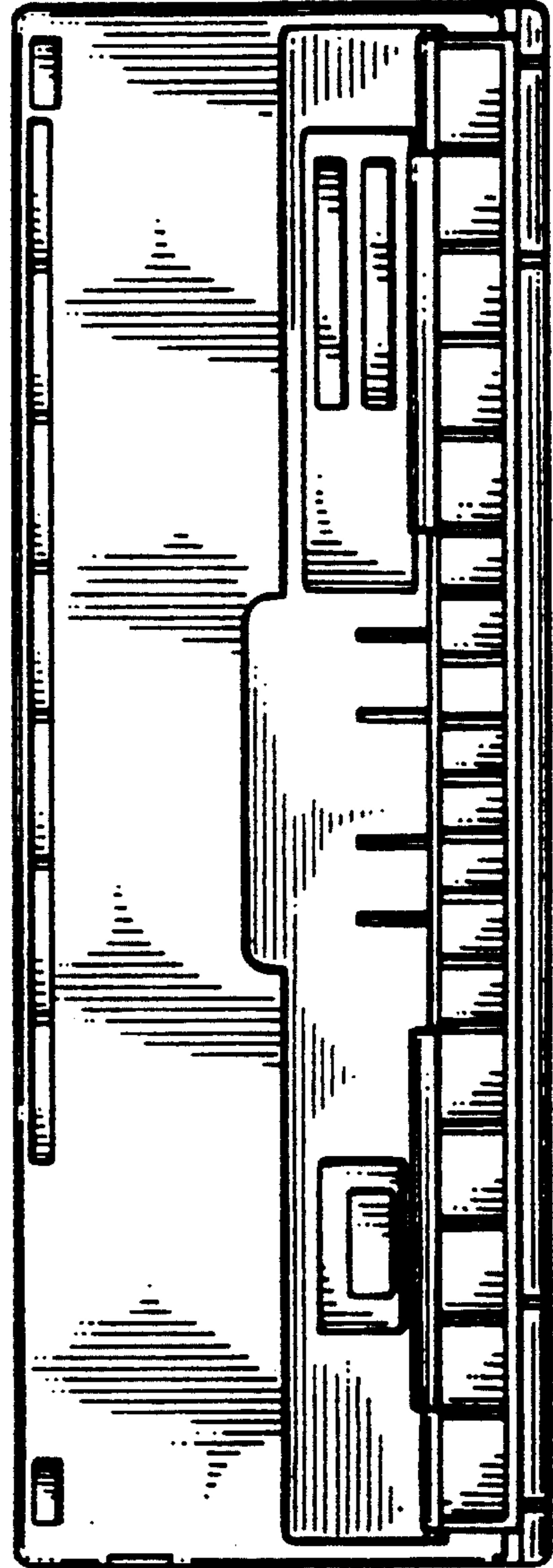
**FIG. 12**



**FIG. 11**



**FIG. 14**



**FIG. 15**