



US00D347625S

# United States Patent [19]

[11] Patent Number: **Des. 347,625**

**Yamazaki**

[45] Date of Patent: **\*\* Jun. 7, 1994**

[54] **PERSONAL COMPUTER**

D. 304,332 10/1989 Hara ..... D14/100 X  
D. 322,778 12/1991 Kline et al. .... D14/100

[75] Inventor: **Kazuhiko Yamazaki**, Hiratsuka, Japan

*Primary Examiner*—Susan J. Lucas  
*Assistant Examiner*—Freda S. Nunn  
*Attorney, Agent, or Firm*—Bernard D. Bogdon

[73] Assignee: **International Business Machines Corporation**, Armonk, N.Y.

[57] **CLAIM**

[\*\*] Term: **14 Years**

The ornamental design for a personal computer, as shown and described.

[21] Appl. No.: **756,116**

**DESCRIPTION**

[22] Filed: **Sep. 6, 1991**

FIG. 1 is a reduced perspective view of a personal computer shown in a horizontal position showing my new design;

[30] **Foreign Application Priority Data**

Mar. 7, 1991 [JP] Japan ..... 3-5965

FIG. 2 is a reduced perspective view thereof shown in a vertical standing position;

[52] U.S. Cl. .... **D14/100**

FIG. 3 is a front elevational view thereof;

[58] Field of Search ..... 360/99.12;

FIG. 4 is a rear elevational view thereof;

361/390-395; D14/100, 101, 102, 109;

FIG. 5 is a top plan view thereof;

D13/162, 184, 199

FIG. 6 is a bottom plan view thereof;

[56] **References Cited**

**U.S. PATENT DOCUMENTS**

D. 293,910 1/1988 Alfonso et al. .... D14/100

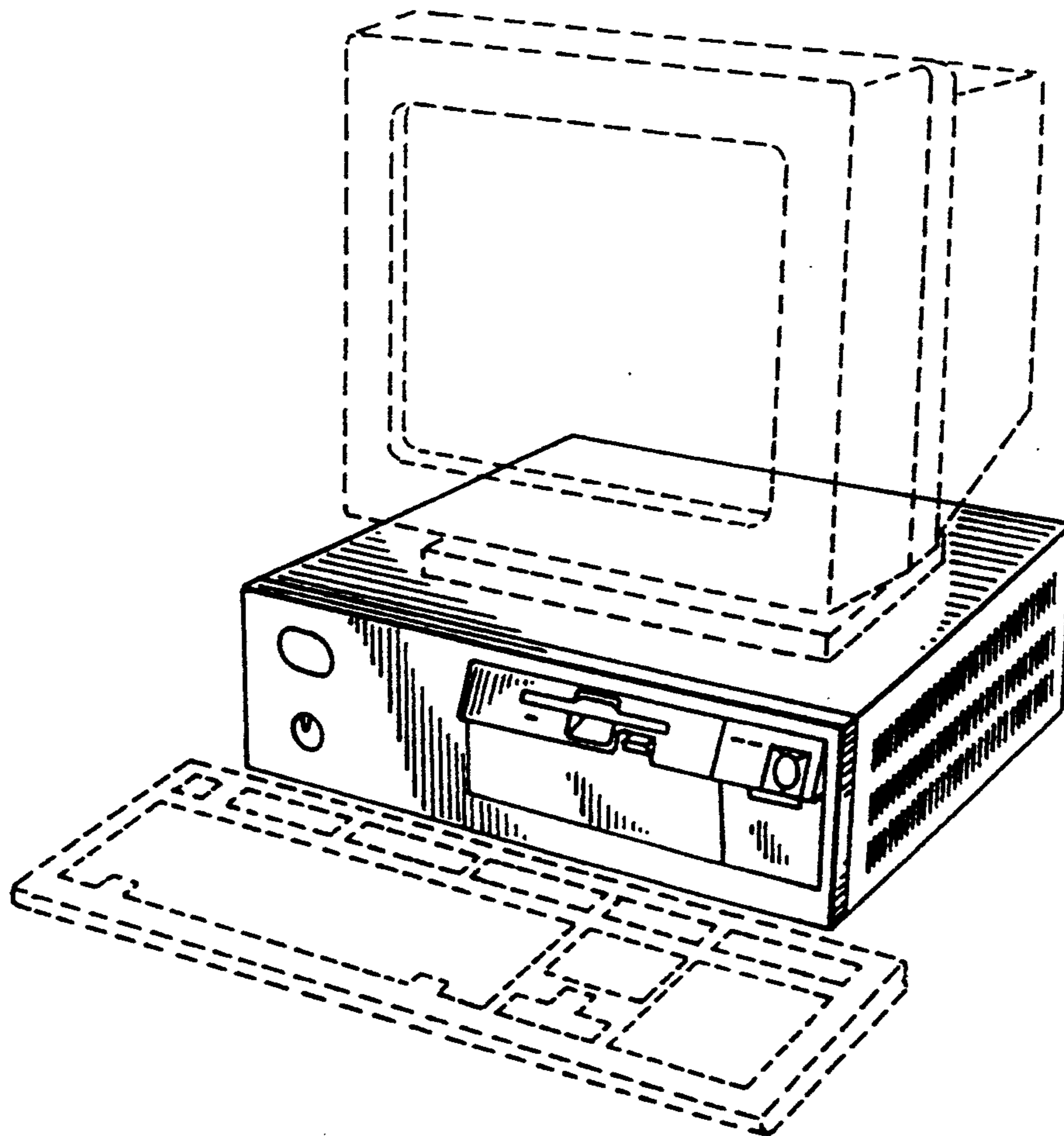
D. 295,043 4/1988 Hara et al. .... D14/100

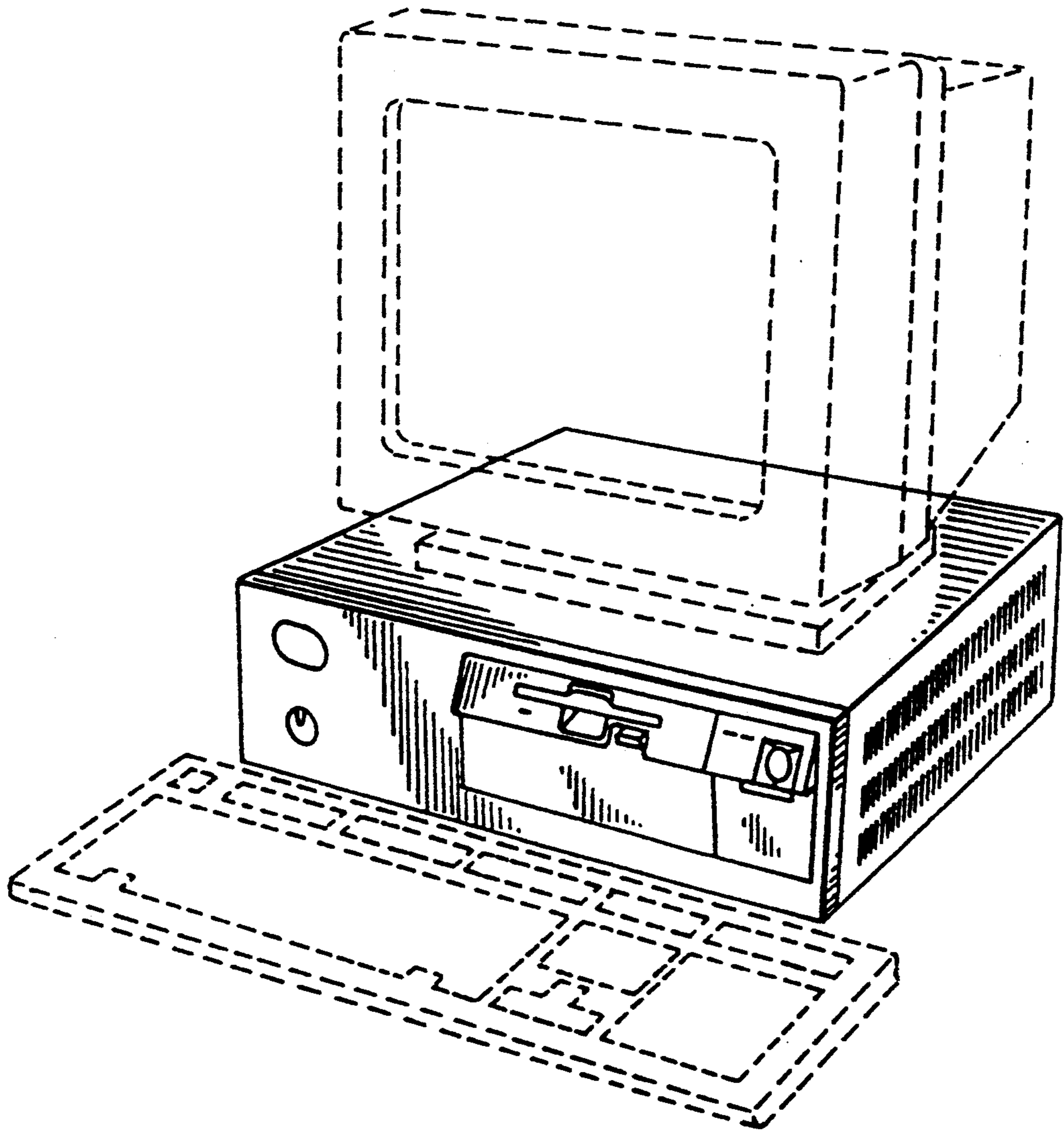
D. 295,749 5/1988 Kelley, Jr. et al. .... D14/100

FIG. 7 is a left side elevational view thereof; and,

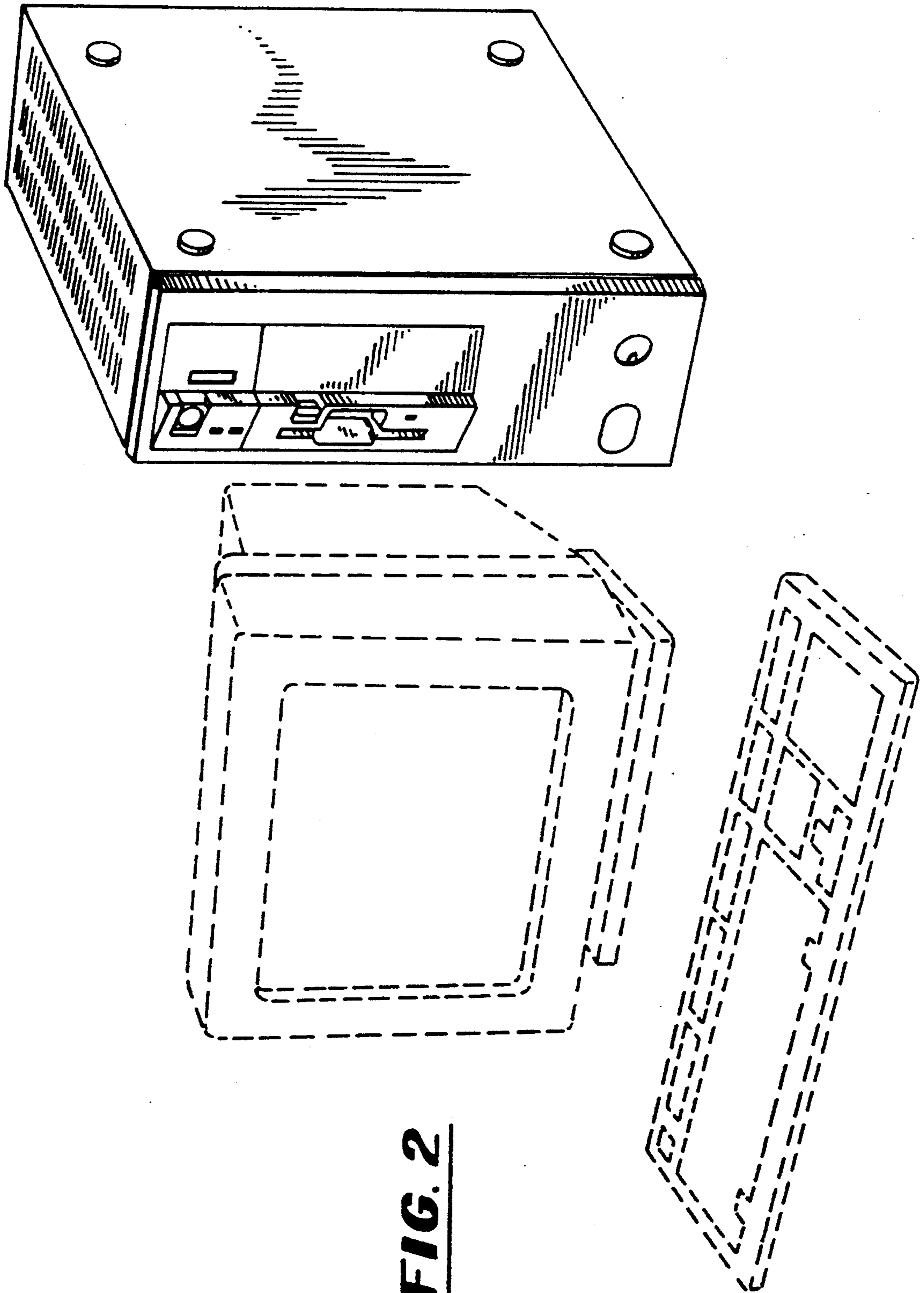
FIG. 8 is a right side elevational view thereof.

The display and keyboard shown in broken lines in FIGS. 1 and 2 are shown for illustrative purposes only and form no part of the claimed design.

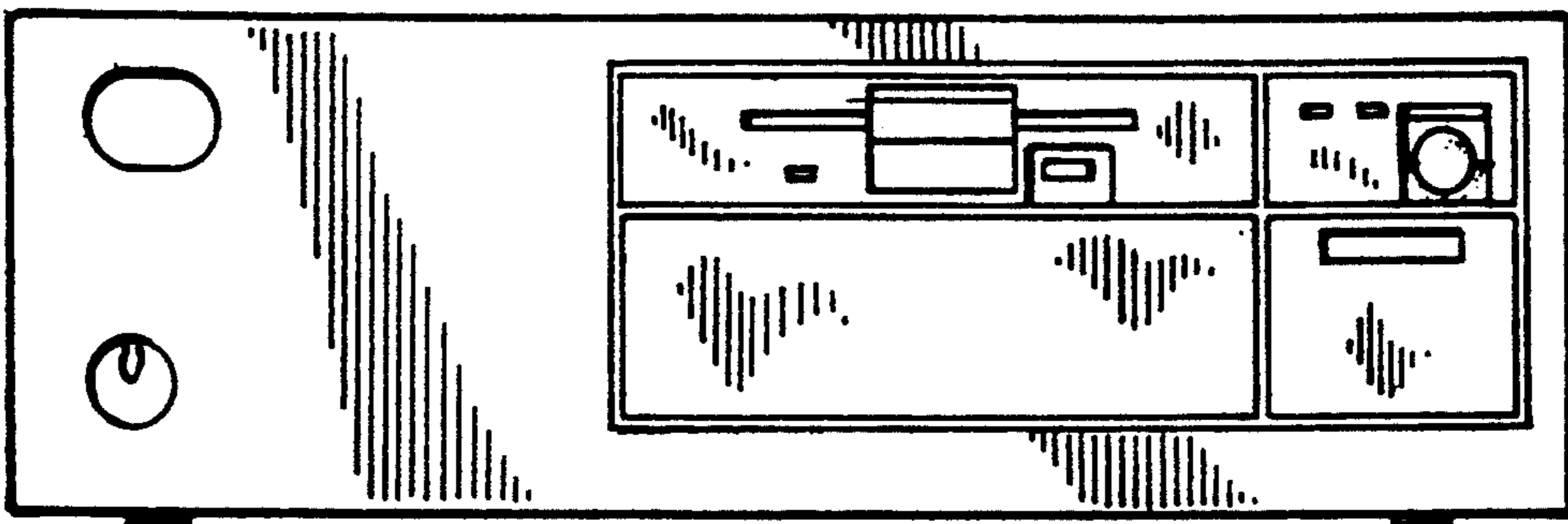




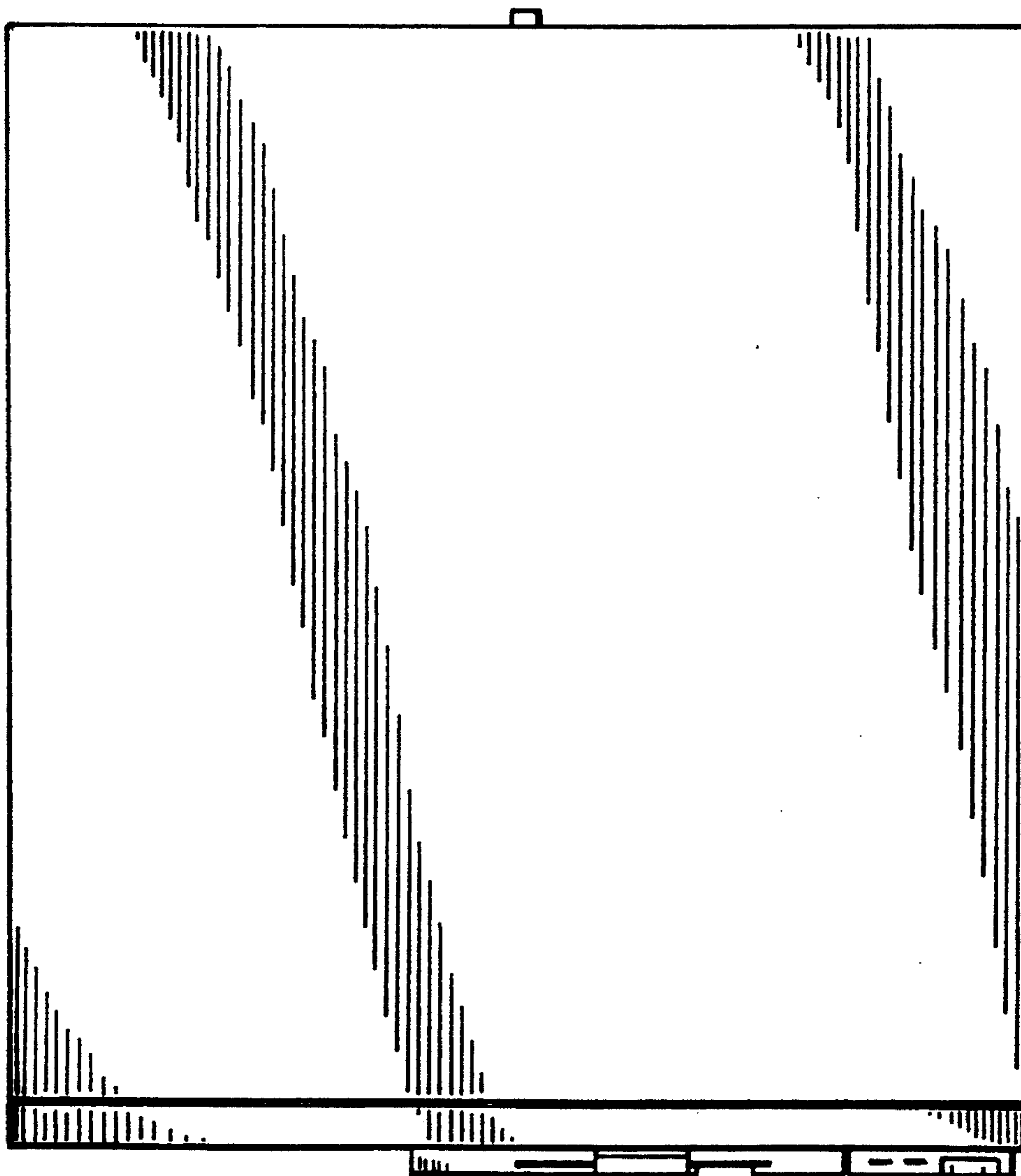
**FIG. 1**



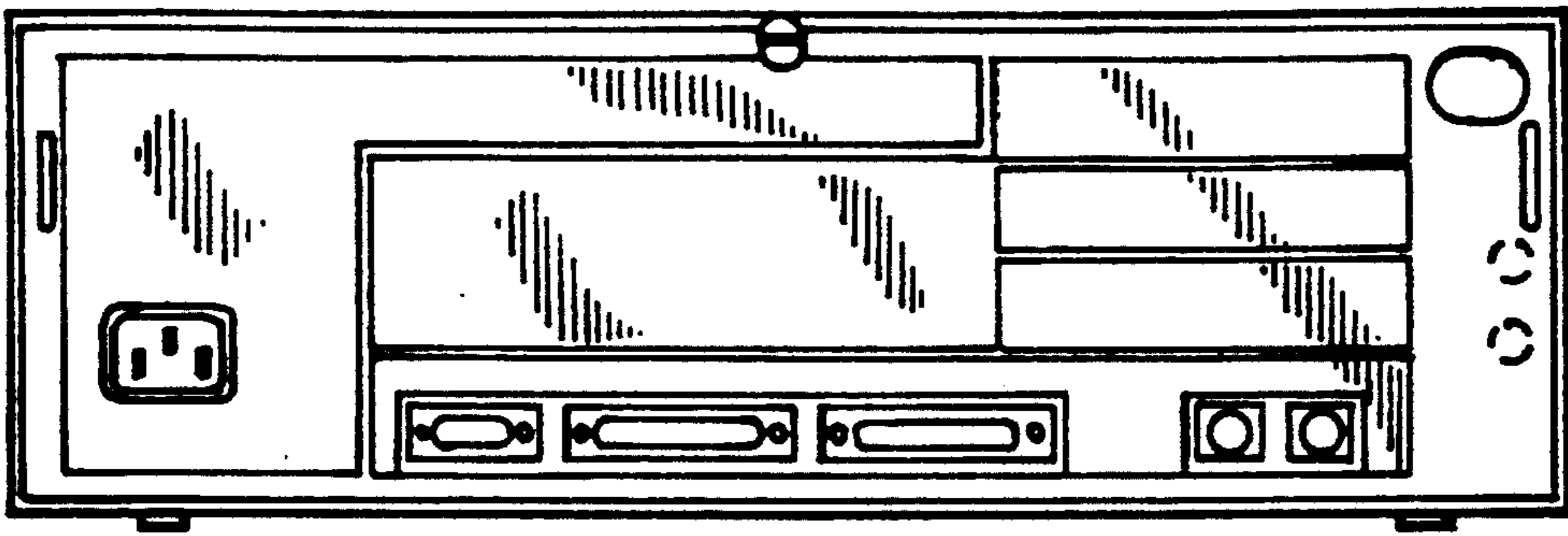
**FIG. 2**



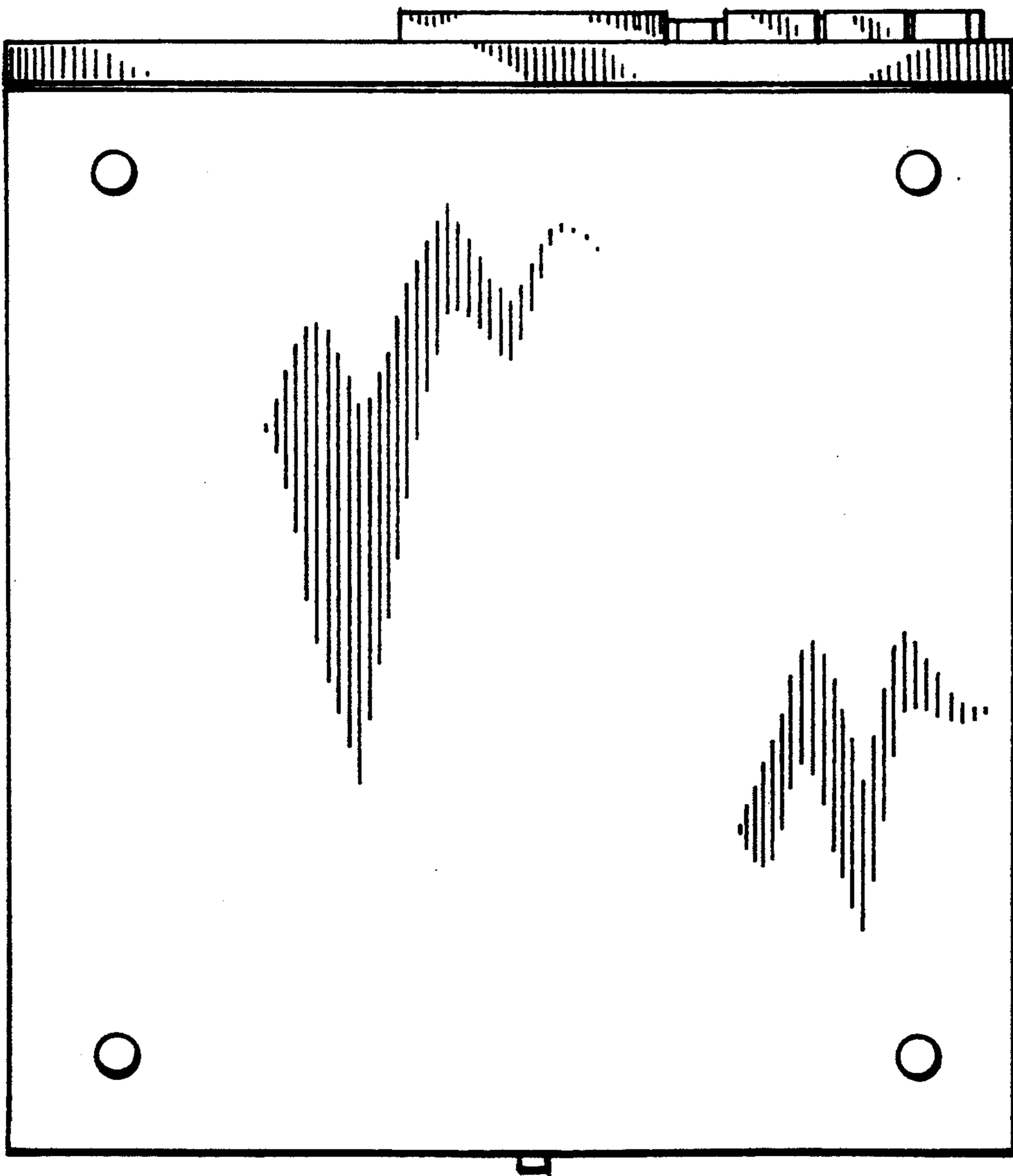
**FIG. 3**



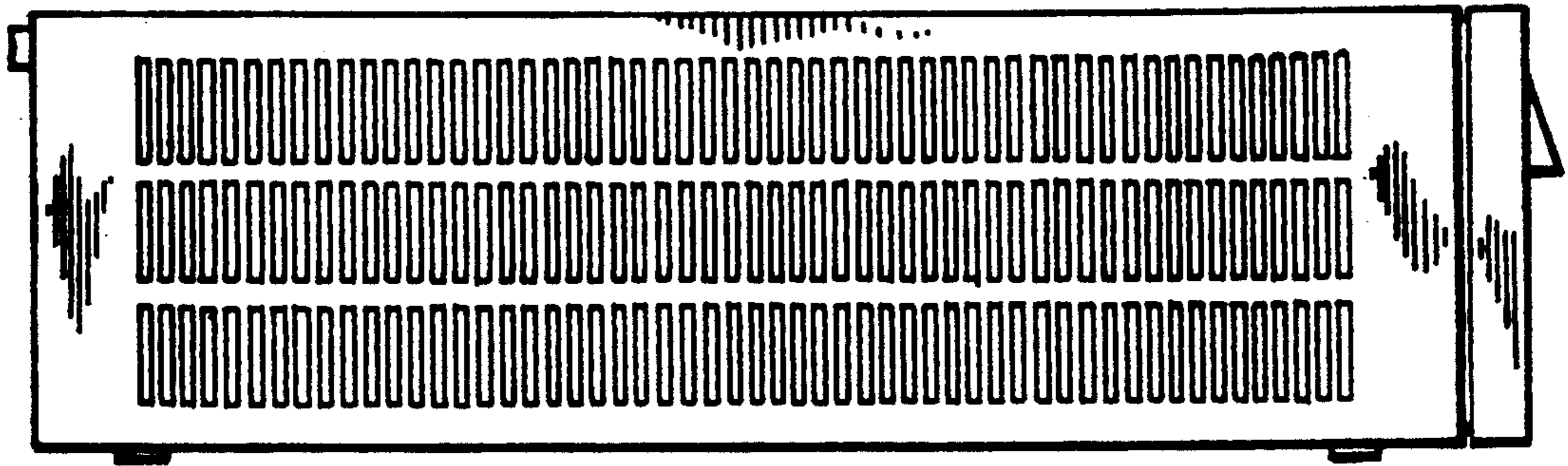
**FIG. 5**



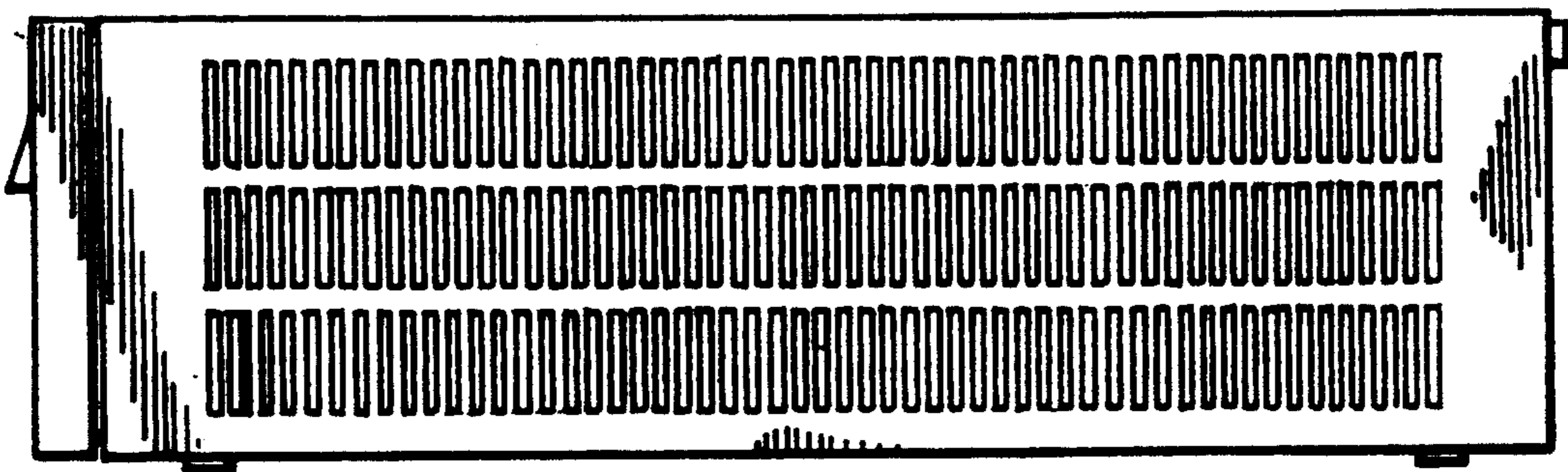
**FIG. 4**



**FIG. 6**



**FIG. 7**



**FIG. 8**