



US00D347564S

**United States Patent** [19]  
**Carsello**

[11] **Patent Number: Des. 347,564**  
[45] **Date of Patent: \*\* Jun. 7, 1994**

[54] **DOOR HANDLESET**

[75] **Inventor: Anthony J. Carsello, Chino, Calif.**

[73] **Assignee: Embart Inc., Newark, Del.**

[\*\*] **Term: 14 Years**

[21] **Appl. No.: 742,656**

[22] **Filed: Aug. 8, 1991**

[52] **U.S. Cl. .... D8/302; D8/320**

[58] **Field of Search ..... D8/300, 301, 302, 315-320,  
D8/350-353; 16/110 R, 111 R, 121; 70/91, 448,  
452, DIG. 67, DIG. 73**

[56] **References Cited**

**U.S. PATENT DOCUMENTS**

- D. 300,113 3/1989 Halsted et al. .... D8/302
- D. 300,114 3/1989 Halsted et al. .... D8/302
- D. 300,115 3/1989 Halsted et al. .... D8/302
- D. 300,202 3/1989 Halsted et al. .... D8/302

**OTHER PUBLICATIONS**

Baldwin Hardware Cat; p. h/15; New York handle-  
set-6562-outside.

Baldwin Hardware Cat; p. h/12; Concord handle-  
set No. 6J7/-outside.

"Grand Openings"-Dexter Designer Series Cat.; p. 4;  
Dallas Handleset.

Kwikset Catalog; ©1988; p. 6; "Toledo" Model.

*Primary Examiner*—B. J. Bullock

*Attorney, Agent, or Firm*—J. Bruce Hoofnagle

[57] **CLAIM**

The ornamental design for door handle-  
set, as shown and described.

**DESCRIPTION**

FIG. 1 is a front elevational view of my new design of  
a door handle-  
set;

FIG. 2 is a right side view of my new design of the door  
handle-  
set, a left side view of my new design of the door  
handle-  
set being a mirror image of the right side view  
thereof;

FIG. 3 is a rear view of my new design of the door  
handle-  
set;

FIG. 4 is a top view of my new design of the door  
handle-  
set;

FIG. 5 is a bottom view of my new design of the door  
handle-  
set;

FIG. 6, 7 and 8 are enlarged sectional views taken along  
lines 6—6, 7—7 and 8—8, respectively, of FIG. 2 show-  
ing design features of a portion of my new design of the  
door handle-  
set;

FIG. 9 is an enlarged sectional view taken along line  
9—9 of FIG. 1 showing design features of a portion of  
my new design of the door handle-  
set;

FIG. 10 is an enlarged view of FIG. 5 showing design  
features of portions of my design of the door handle-  
set  
as viewed from the bottom;

FIG. 11 is an enlarged view of FIG. 4 showing design  
features of portions of my design of the door handle-  
set  
as viewed from the top; and,

FIG. 12 is a reduced perspective view of my new  
design of the door handle-  
set.

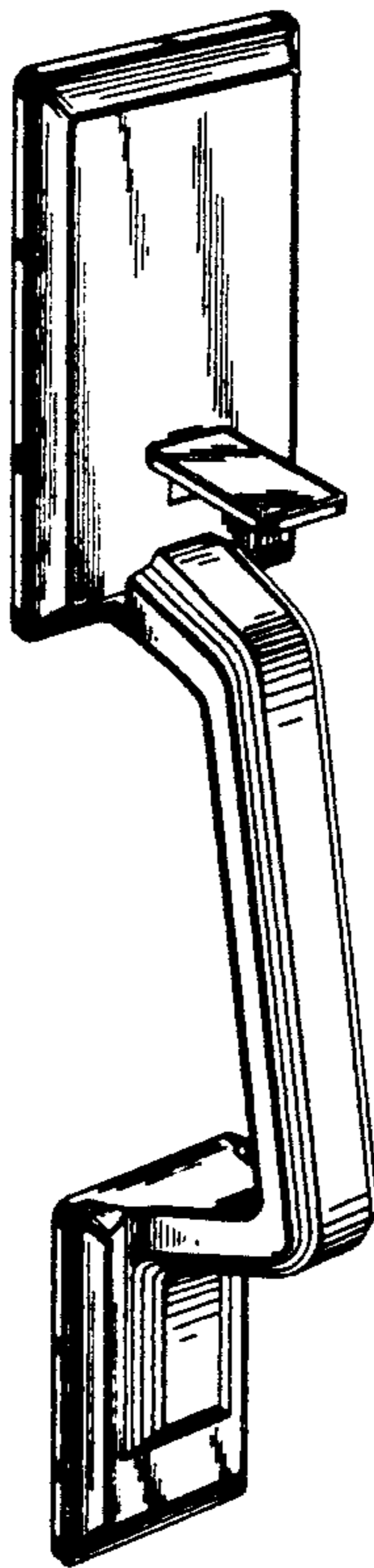


Fig. 1

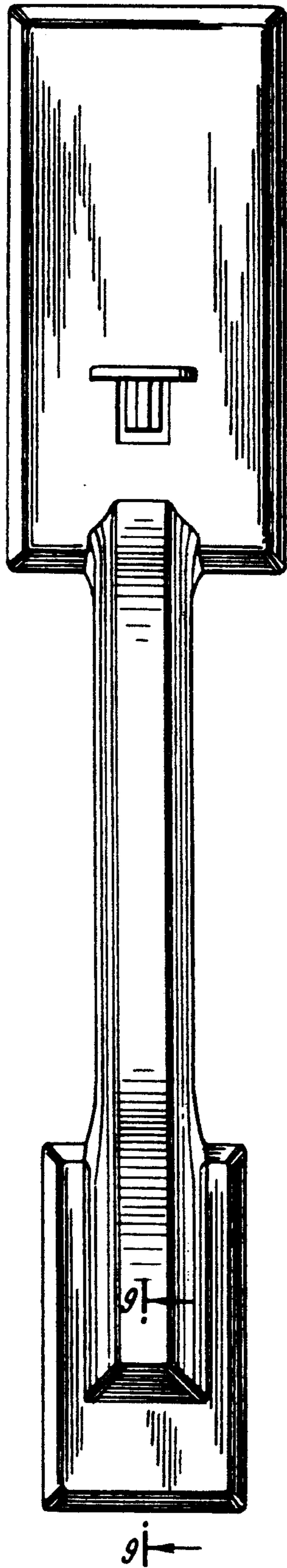
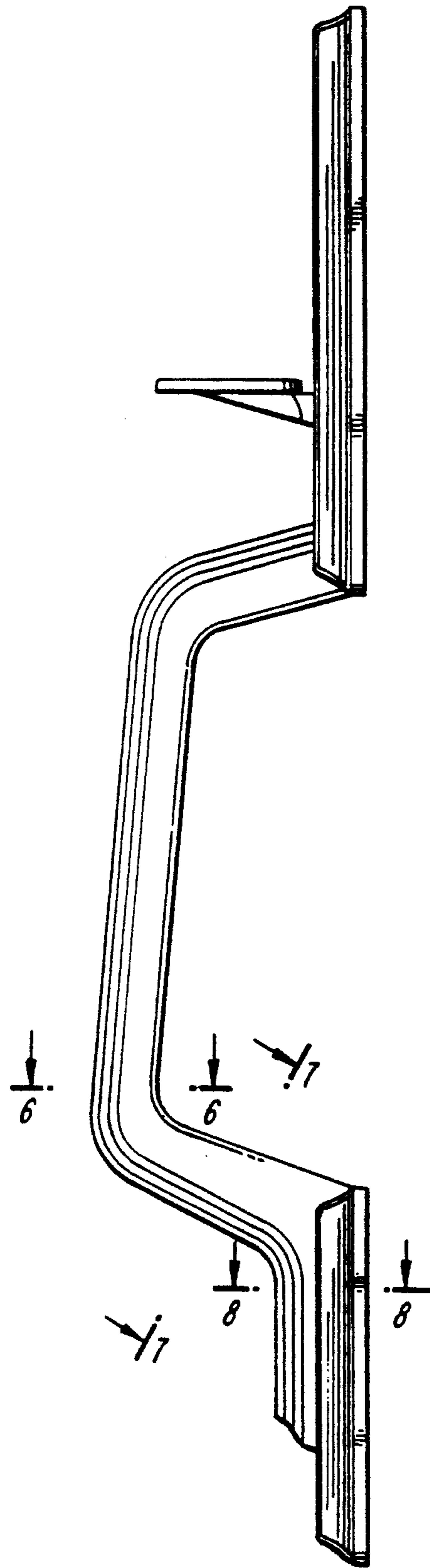
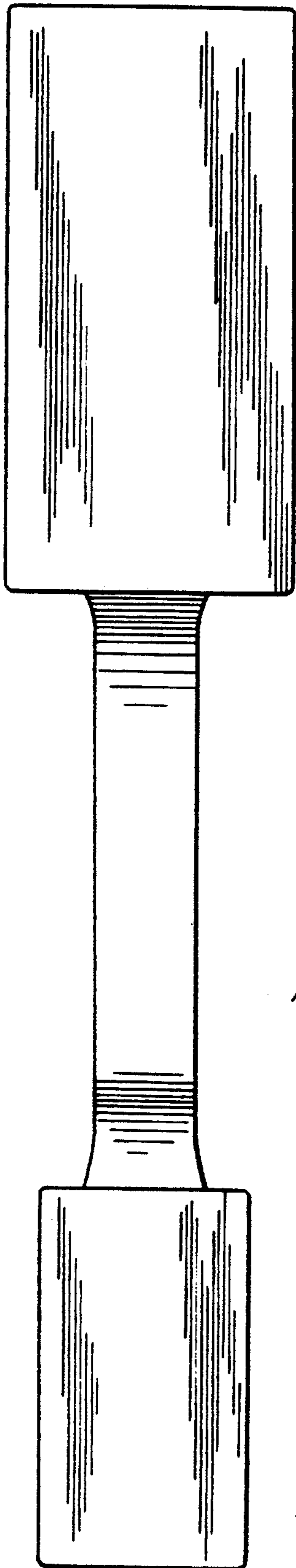


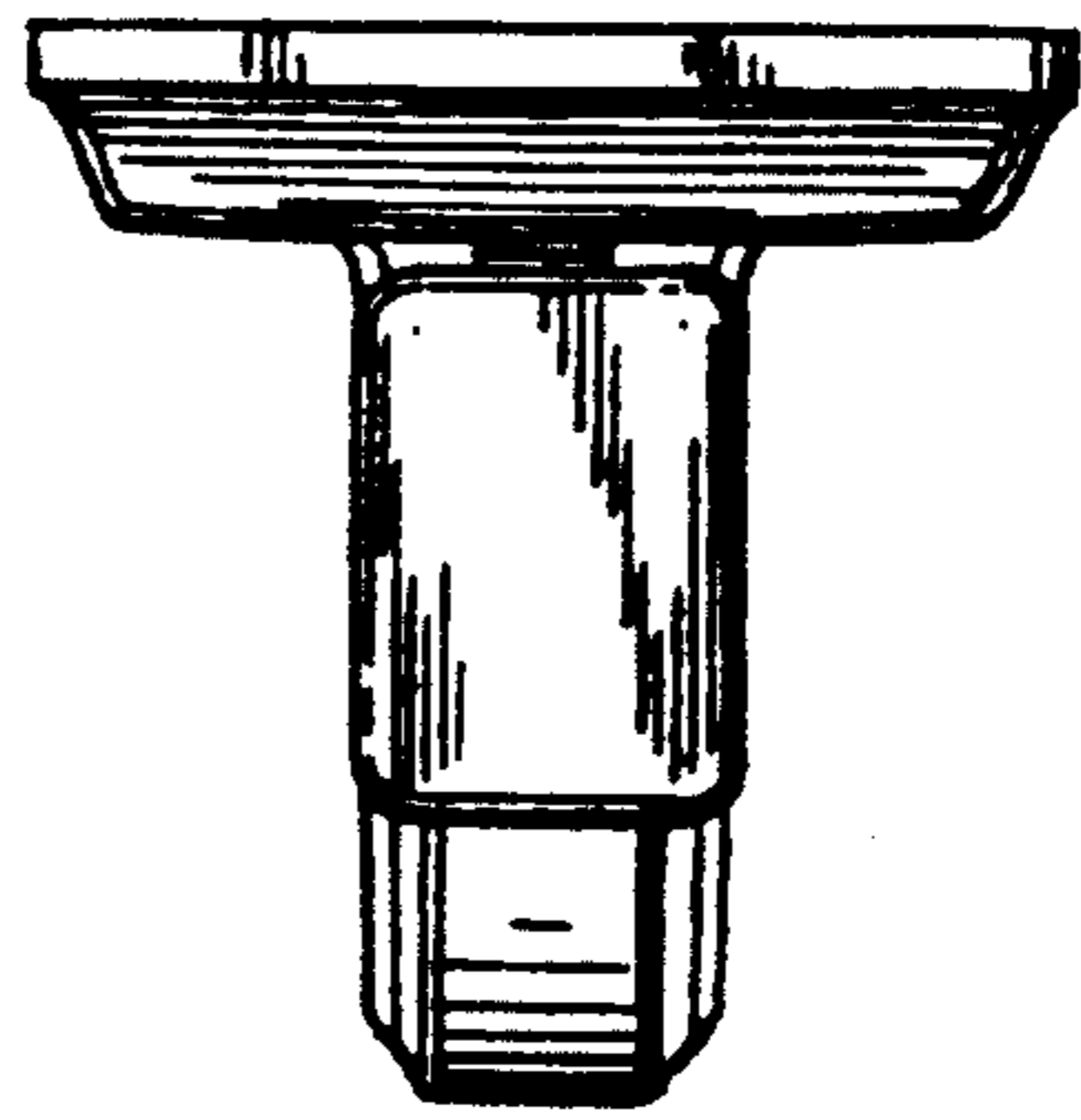
Fig. 2



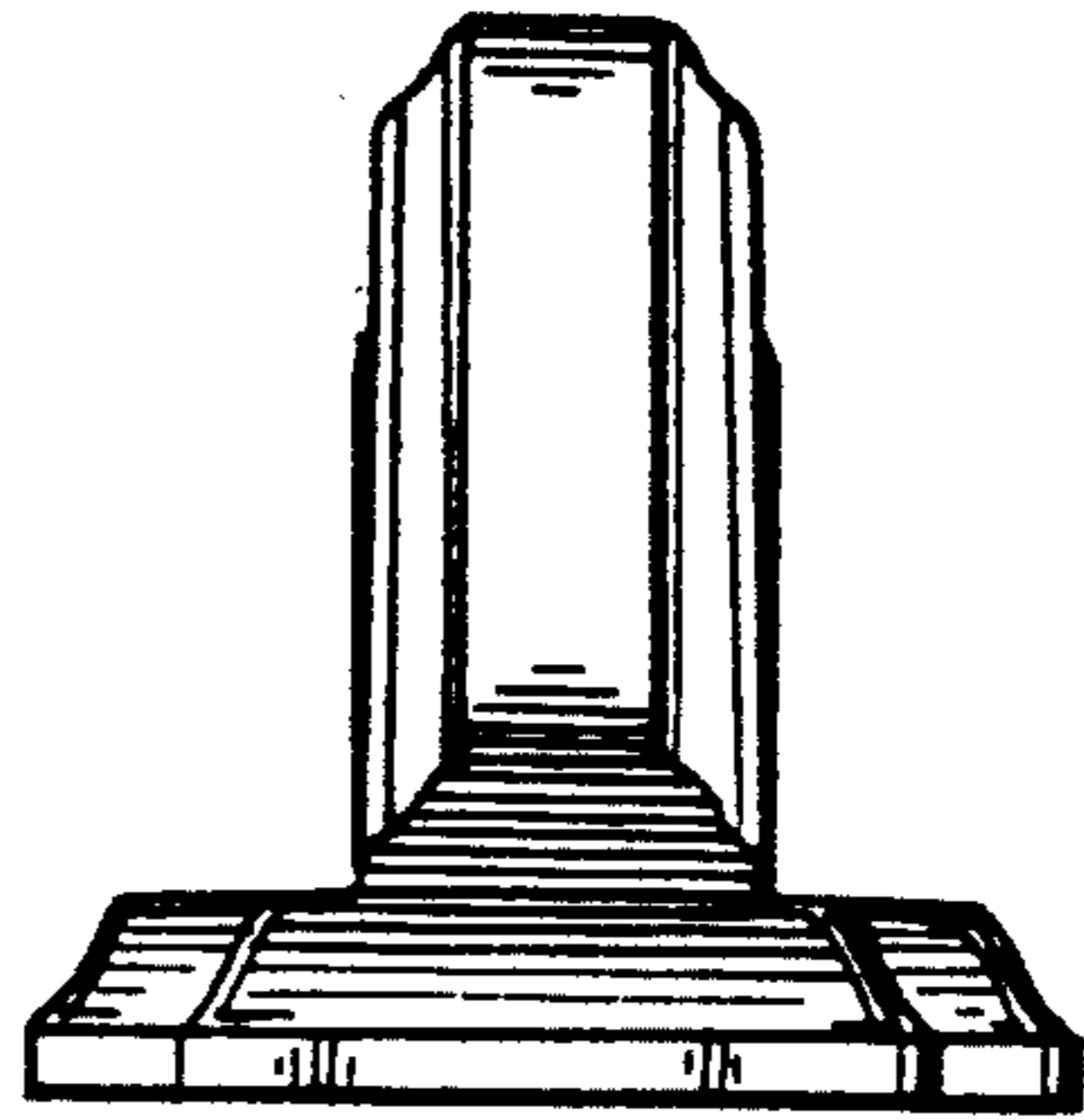
*Fig. 3*



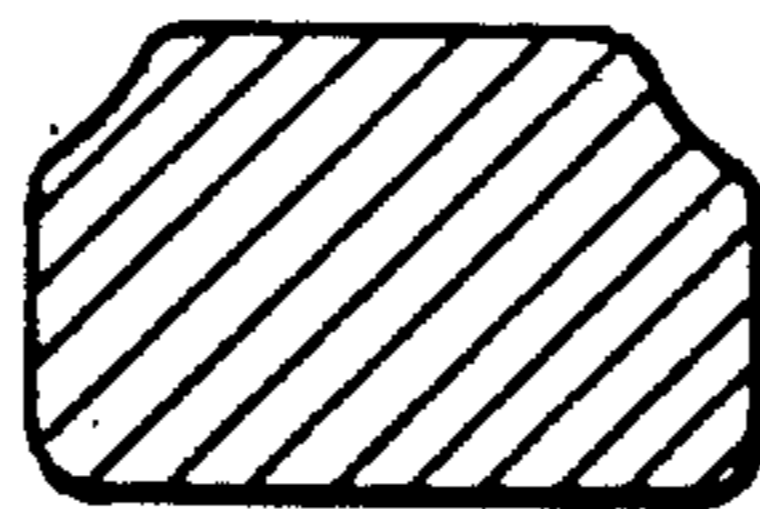
*Fig. 4*



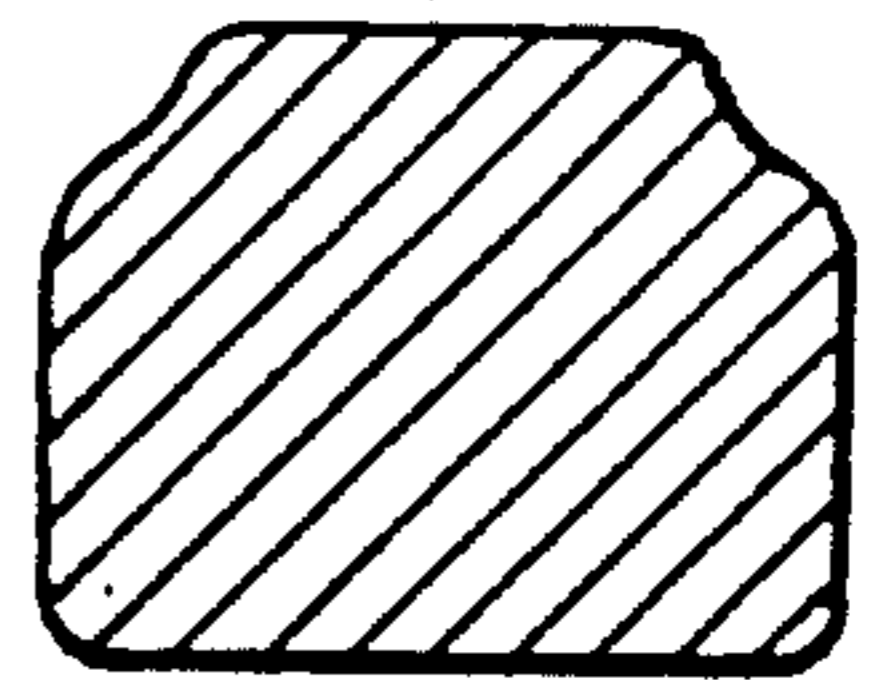
*Fig. 5*



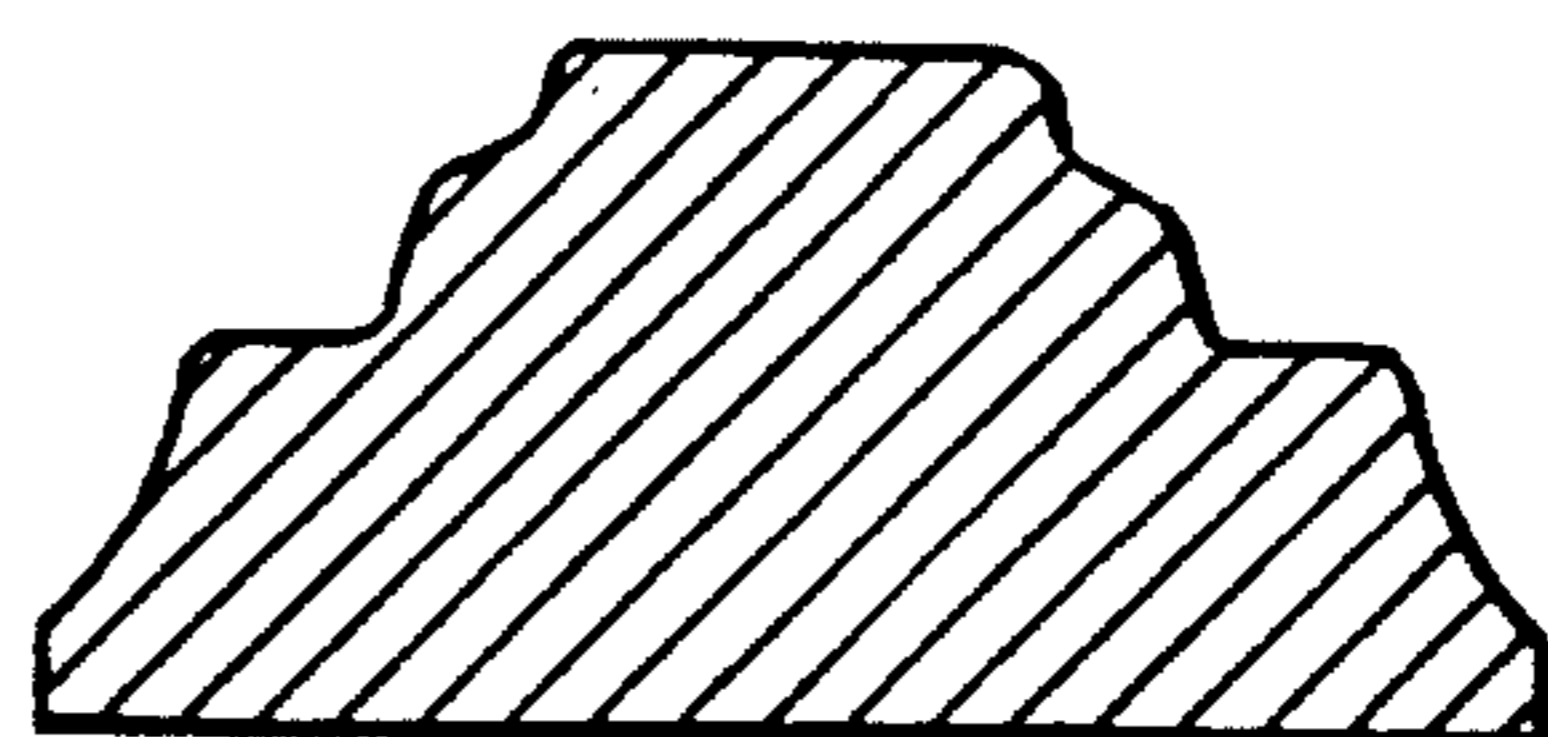
*Fig. 6*

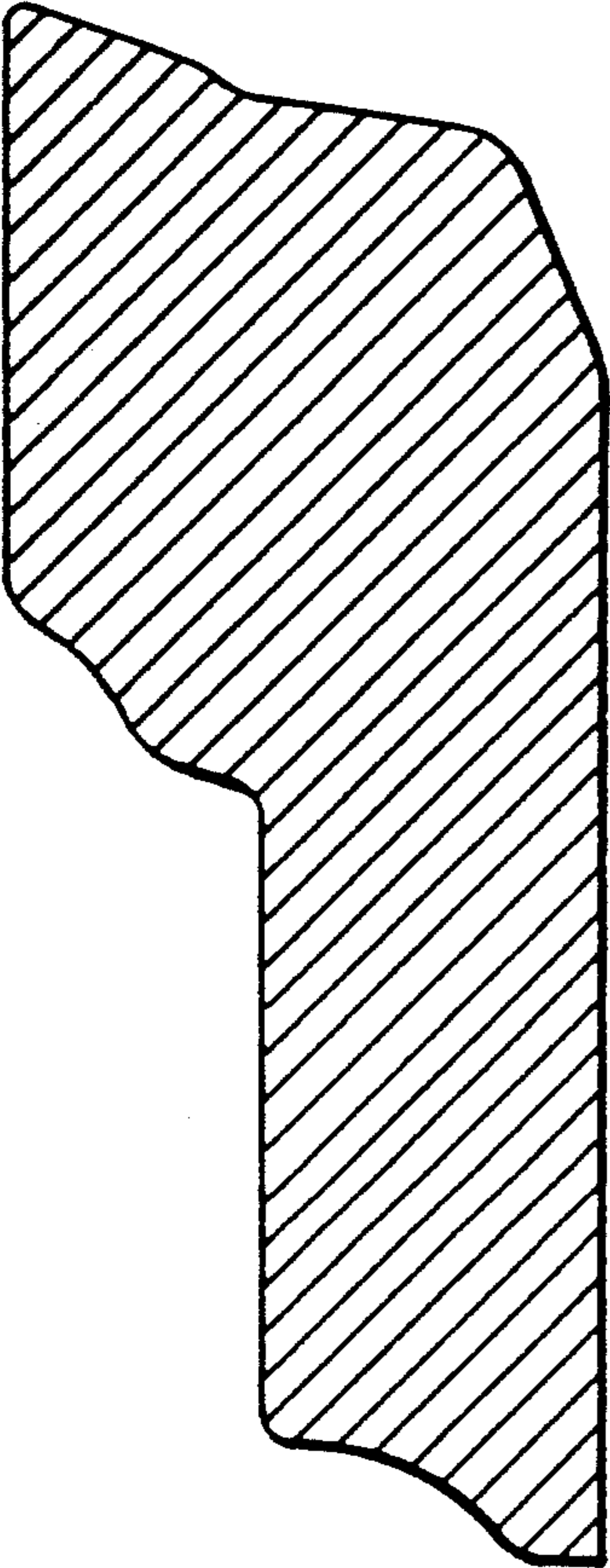


*Fig. 7*

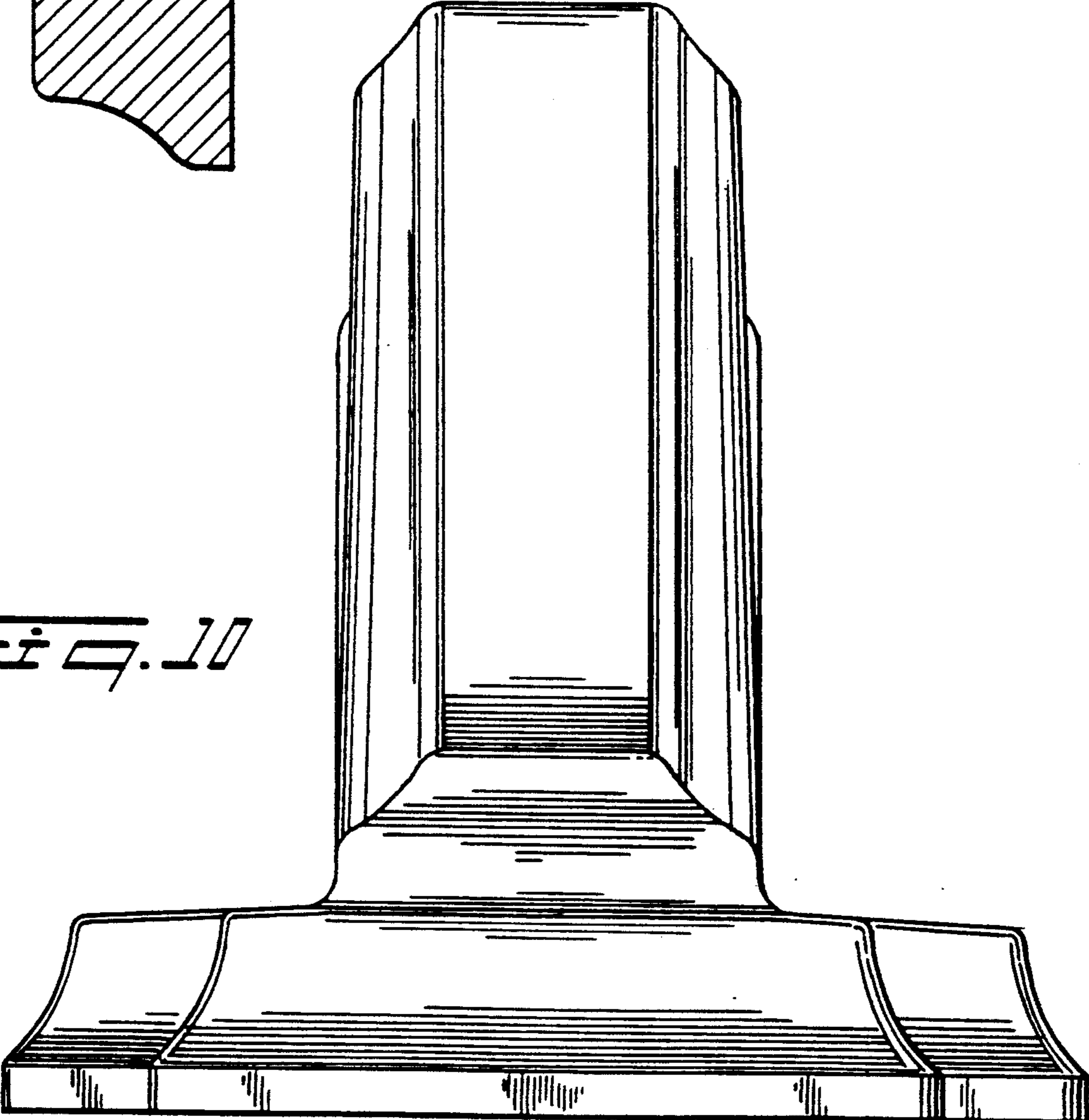


*Fig. 8*





*Fig. 9*



*Fig. 10*

