



US00D347538S

# United States Patent [19]

[11] Patent Number: **Des. 347,538**

**Fleischer**

[45] Date of Patent: **\*\* Jun. 7, 1994**

[54] **CURLING IRON AND HAIRDRYER HOLDER**

3,990,755 11/1976 Kravse ..... 211/66 X  
4,583,647 4/1986 Schinzing ..... 211/70.6 X  
4,871,074 10/1989 Bryson et al. .... D6/570 X

[76] Inventor: **David G. Fleischer, 3315 S. Riviera Dr., Salt Lake City, Utah 84106**

### FOREIGN PATENT DOCUMENTS

[\*\*] Term: **14 Years**

700570 11/1940 Fed. Rep. of Germany ..... 211/65

[21] Appl. No.: **775,373**

*Primary Examiner*—Bernard Ansher

[22] Filed: **Oct. 15, 1991**

*Assistant Examiner*—C. Tuttle

[52] U.S. Cl. .... **D6/567; D28/73; D6/527; D6/528; D6/531**

*Attorney, Agent, or Firm*—M. Reid Russell

[58] Field of Search ..... **D6/512, 524-535, D6/567; D8/371-373; 211/13, 60.1, 70.1, 70.6, 86-88; 248/309.1, 314; D28/38, 73-75, 61**

### [57] CLAIM

The ornamental design for a curling iron and hairdryer holder, as shown and described.

### [56] References Cited

### DESCRIPTION

#### U.S. PATENT DOCUMENTS

- D. 215,100 9/1969 Seller ..... D6/528
- D. 243,426 2/1977 Joslyn ..... D6/567
- D. 262,337 12/1981 Bateman et al. .... D6/572
- D. 262,504 1/1982 Flynn ..... D6/574
- D. 280,582 9/1985 Del Garbino et al. .... D28/73 X
- 2,508,945 5/1950 Hever ..... 211/75

FIG. 1 is a perspective view of the curling iron and hairdryer holder showing my new design; FIG. 2 is a top plan view thereof; FIG. 3 is a front elevation view thereof; FIG. 4 is a rear elevation view thereof; FIG. 5 is a left side elevation view, the right side elevation view being the mirror image thereof; and, FIG. 6 is a bottom plan view thereof.

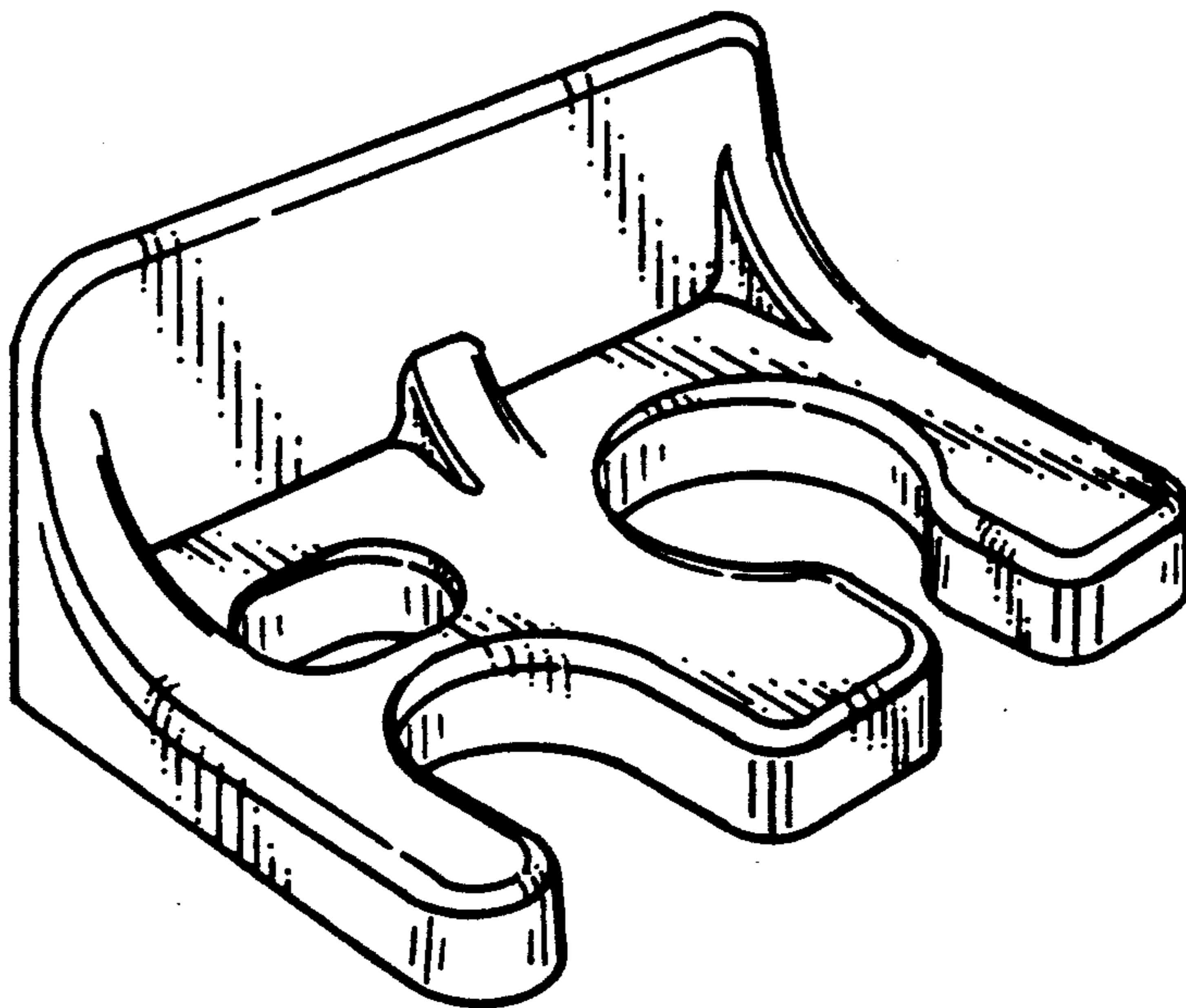

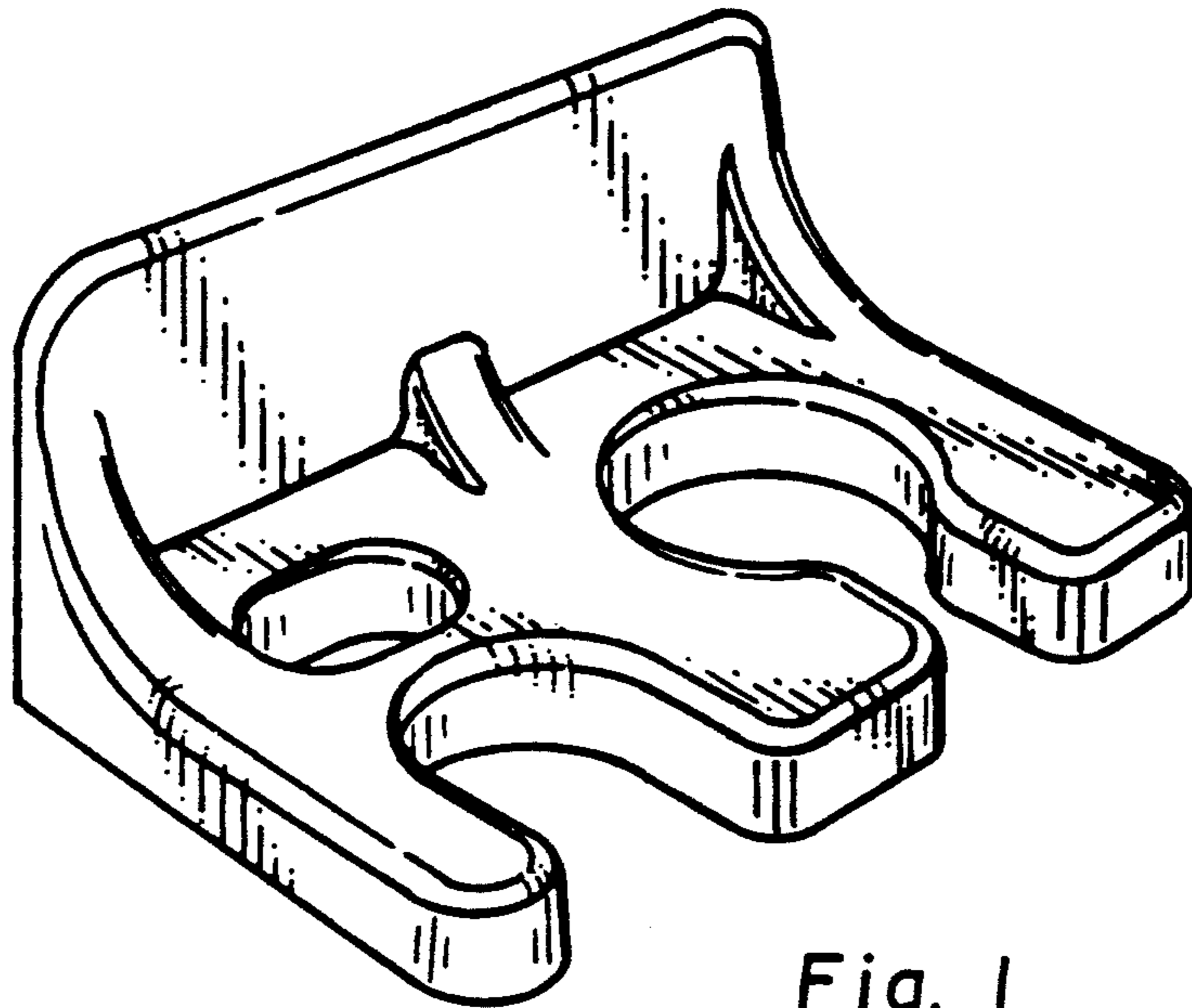

Fig. 1

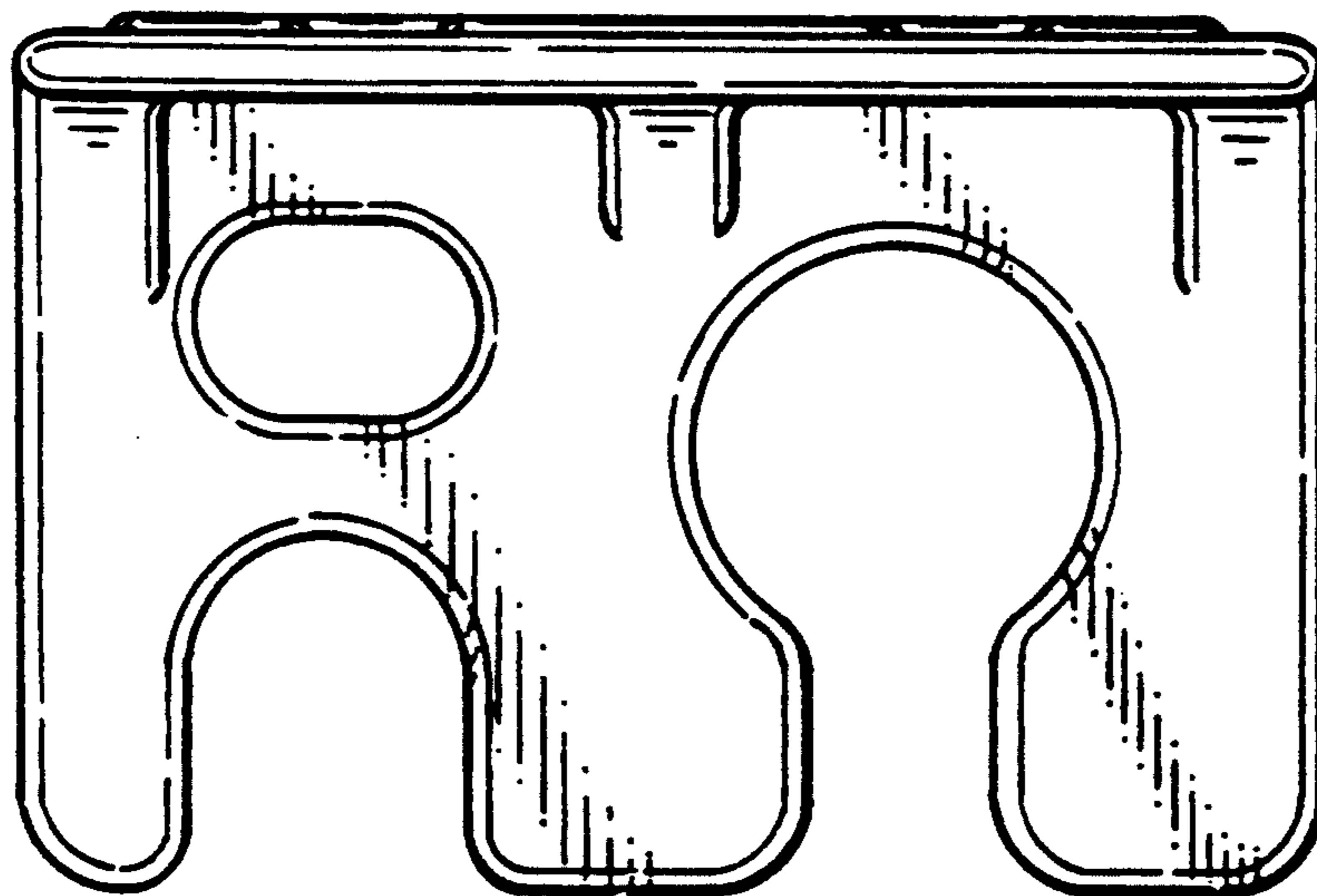

Fig. 2

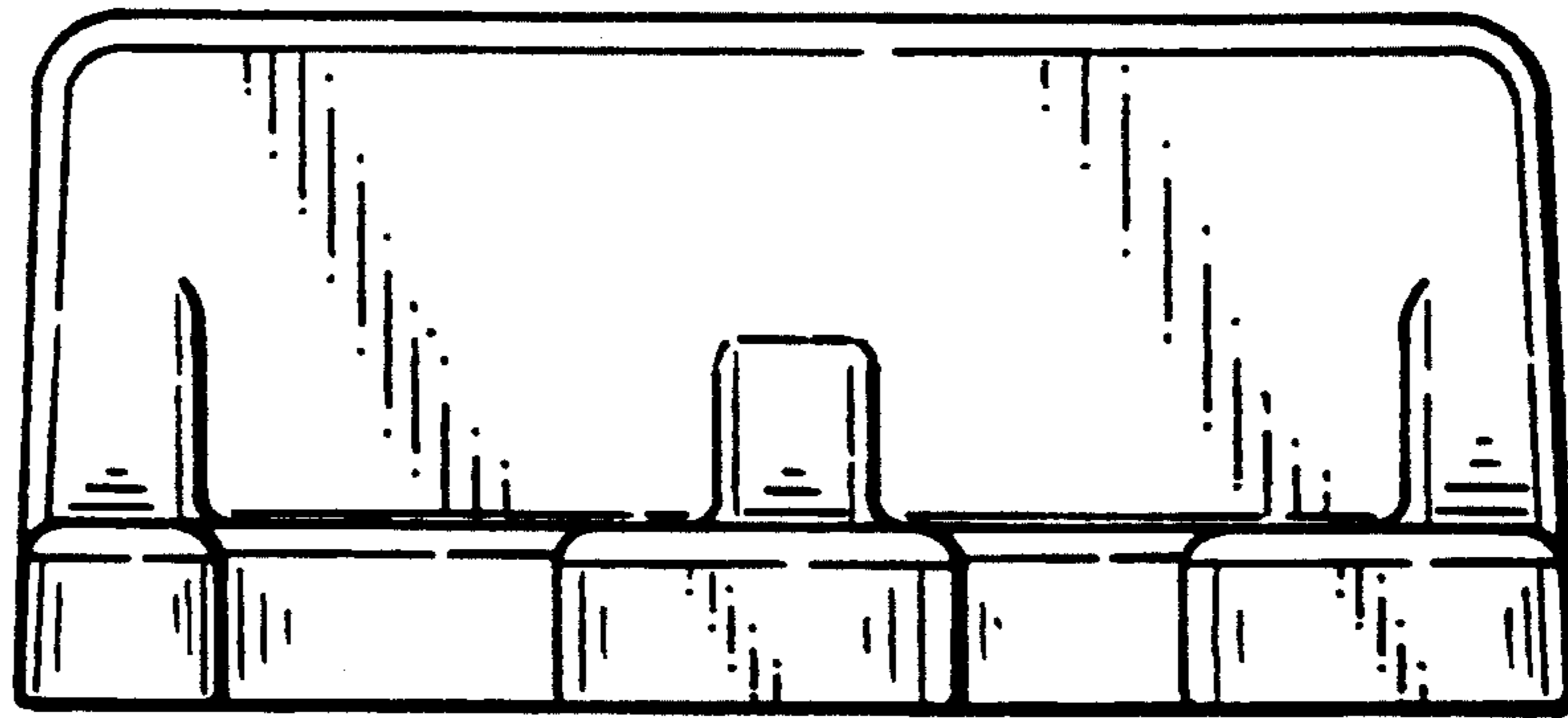

Fig. 3

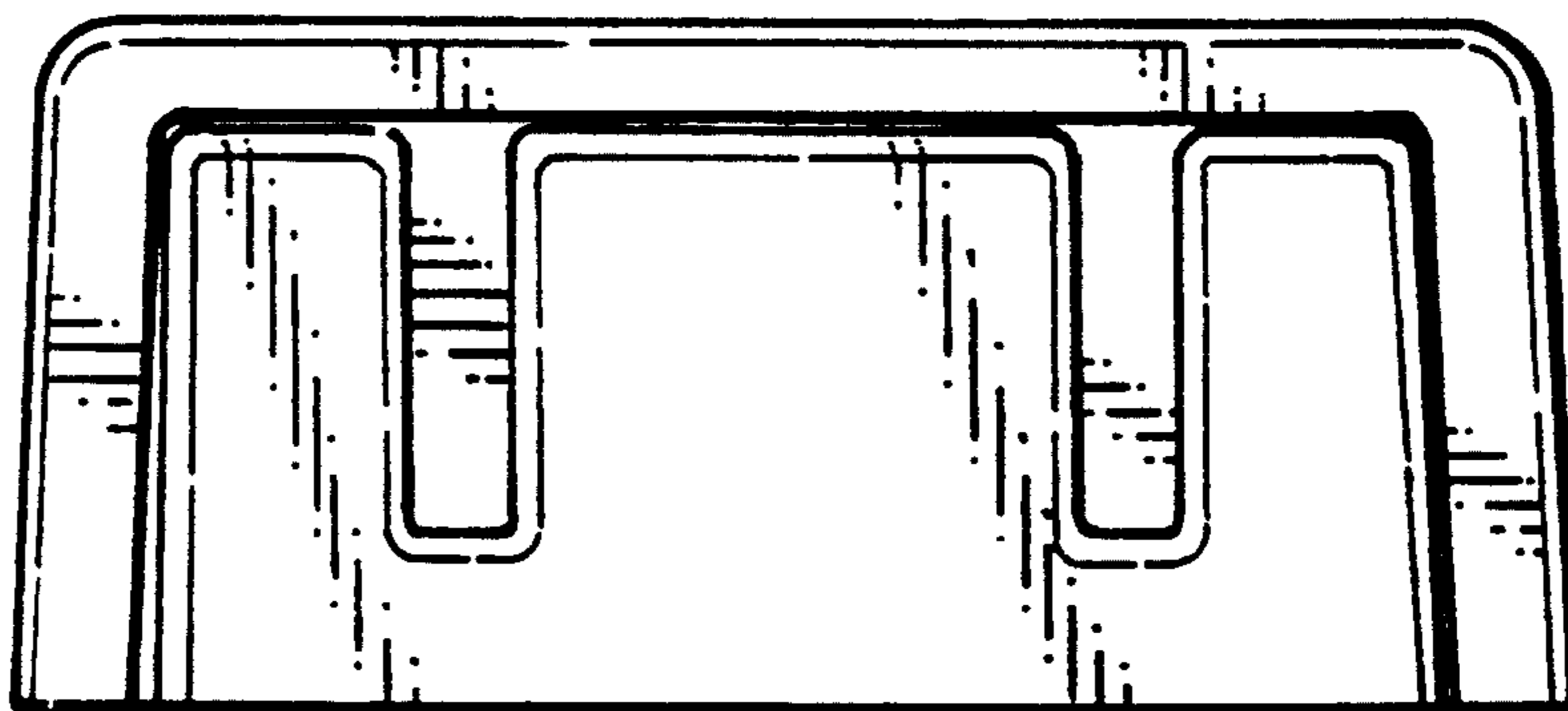

Fig. 4

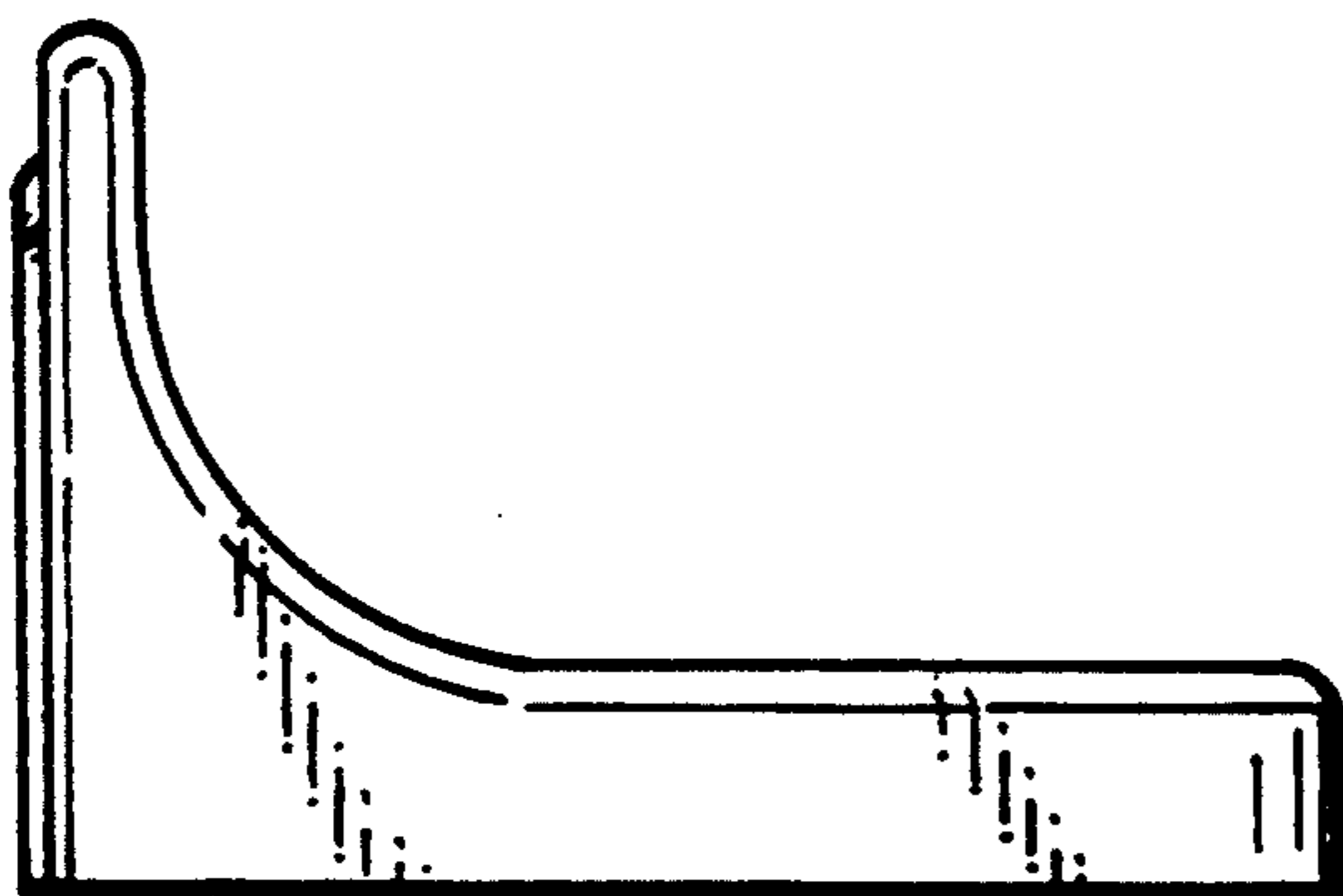

Fig. 5

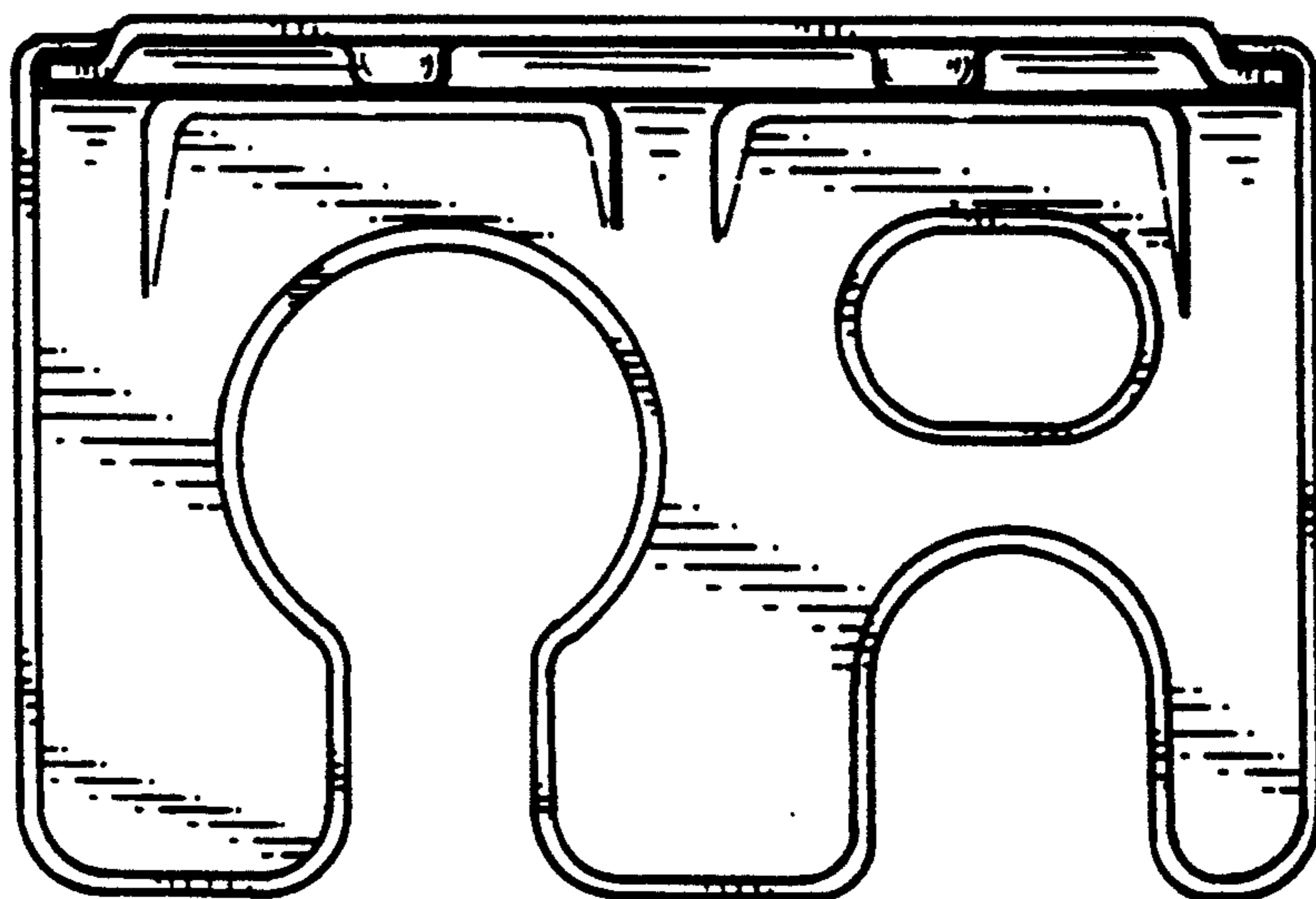

Fig. 6