



US00D347291S

United States Patent [19]

[11] Patent Number: **Des. 347,291**

Kramer

[45] Date of Patent: **** May 24, 1994**

[54] **MULTI-SHADE ARC BOOM LAMP**

Attorney, Agent, or Firm—Timothy T. Tyson

[76] Inventor: **Barry L. Kramer**, 6180 S. St. Andrews Pl., Los Angeles, Calif. 90047

[57] **CLAIM**

The ornamental design for a multi-shade arc boom lamp, as shown and described.

[**] Term: **14 Years**

DESCRIPTION

[21] Appl. No.: **9,772**

FIG. 1 is a front elevational view of a multi-shade arc boom lamp showing my new design;

[22] Filed: **Jun. 24, 1993**

FIG. 2 is a right side elevational view of FIG. 1, the left side elevational view being the mirror image thereof;

Related U.S. Application Data

[62] Division of Ser. No. 884,959, May 18, 1992, Des. No. 341,000.

FIG. 3 is a top plan view of FIG. 1;

[52] U.S. Cl. **D26/102; D26/128**

FIG. 4 is a bottom plan view of FIG. 1;

[58] Field of Search **362/410-414; D26/93, 102-112, 128-136**

FIG. 5 is a rear elevational view of FIG. 1;

FIG. 6 is an enlarged top plan view of a single shade of FIG. 1;

FIG. 7 is an enlarged side elevational view of a single shade of FIG. 1;

[56] **References Cited**

PUBLICATIONS

Best Catalog, 1988/1989, p. 165, Arc Floor Lamp #14. Hammacher Schlemmer Holiday Catalog, p. 68, Banker's Halogen Desk Lamp.

Home Lighting & Accessories, Jul. 1989, p. 109, Easy-lite Arc Floor Lamp.

FIG. 8 is a bottom plan view of a single shade of FIG. 1;

FIG. 9 is a front elevational view of a second embodiment thereof;

FIG. 10 is a right side elevational view of FIG. 9, the left side elevational view being the mirror image thereof;

FIG. 11 is a top plan view of FIG. 9;

FIG. 12 is a bottom plan view of FIG. 9; and,

FIG. 13 is a rear elevational view of FIG. 9.

Primary Examiner—Susan J. Lucas

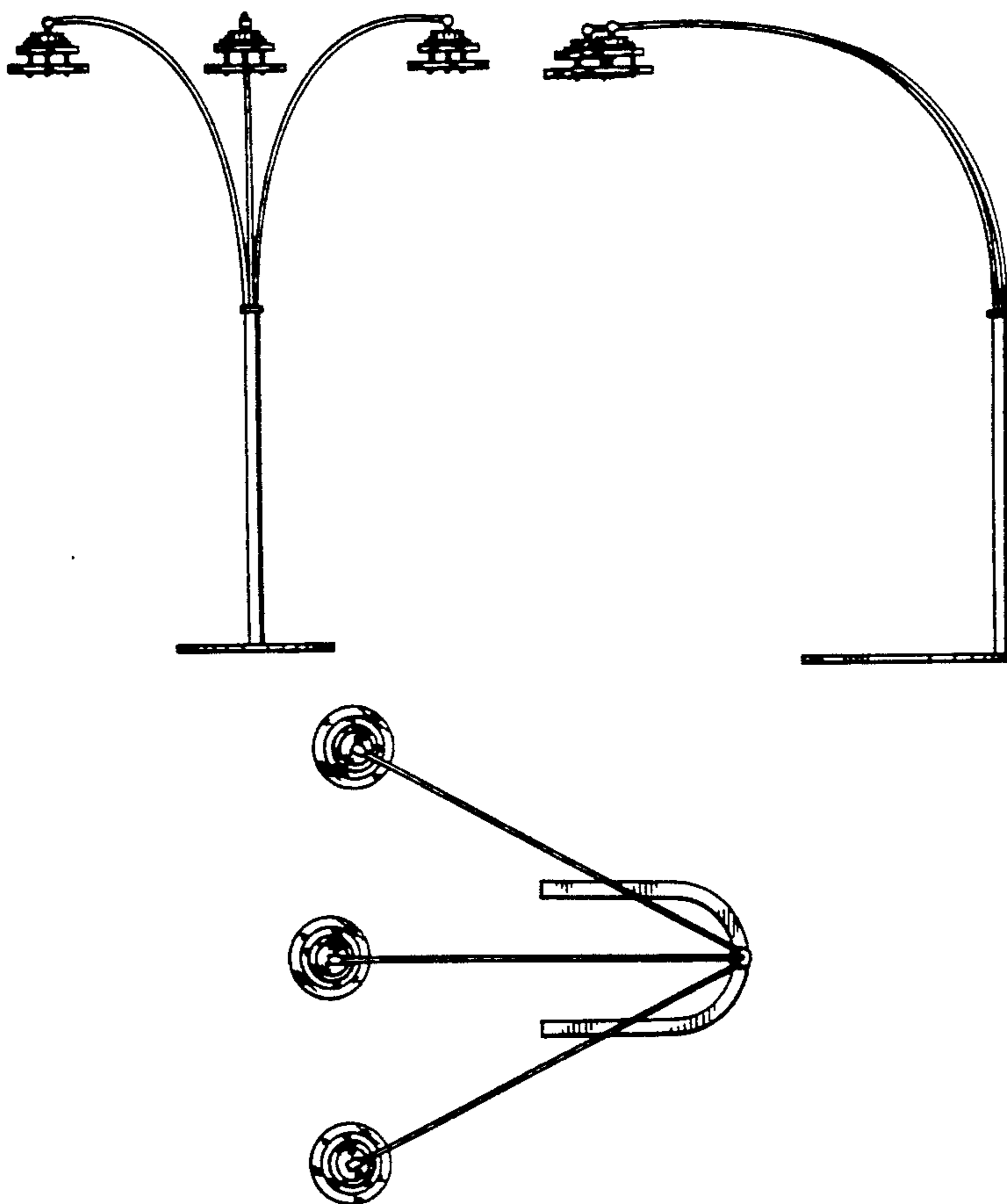

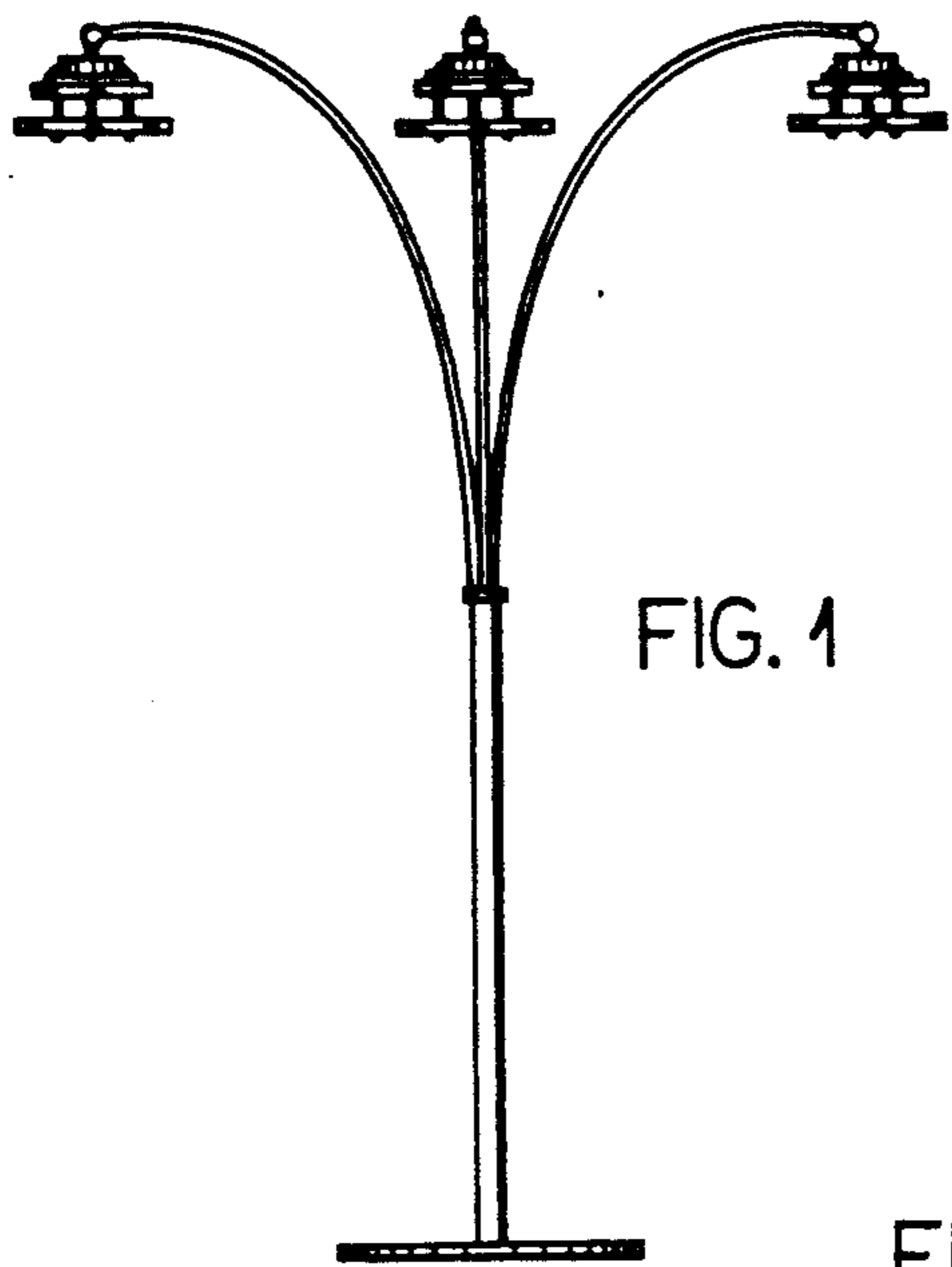

FIG. 1

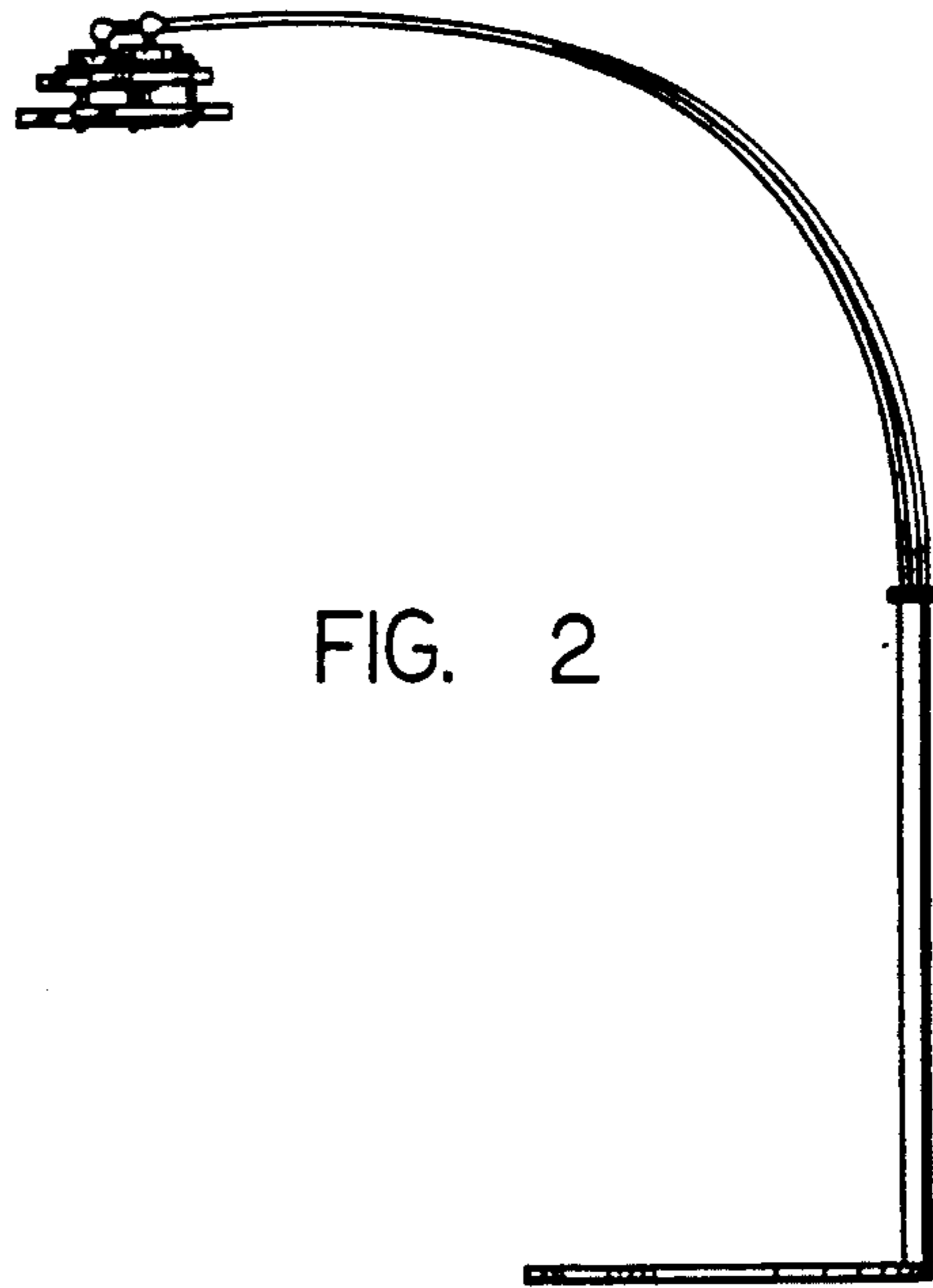

FIG. 2

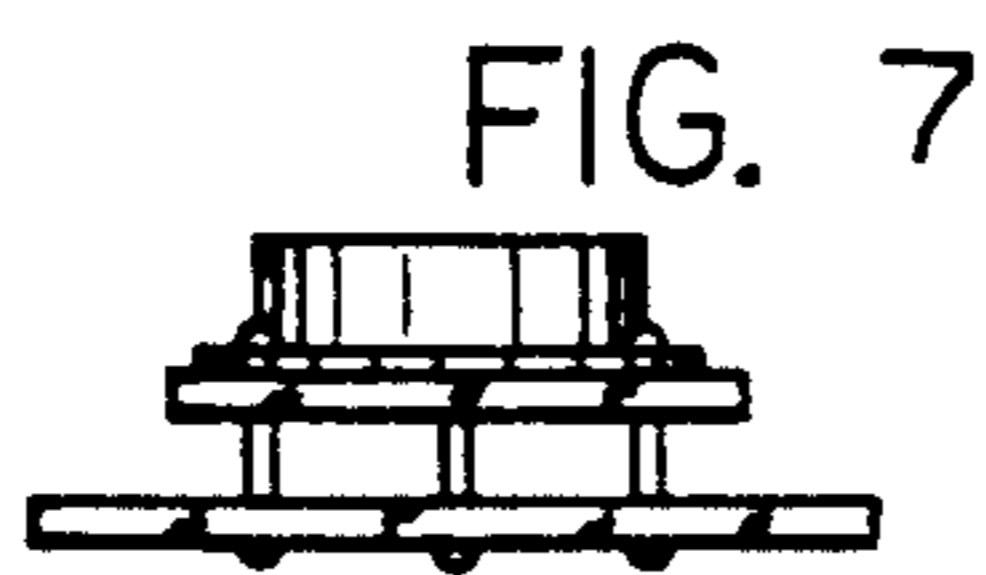

FIG. 7

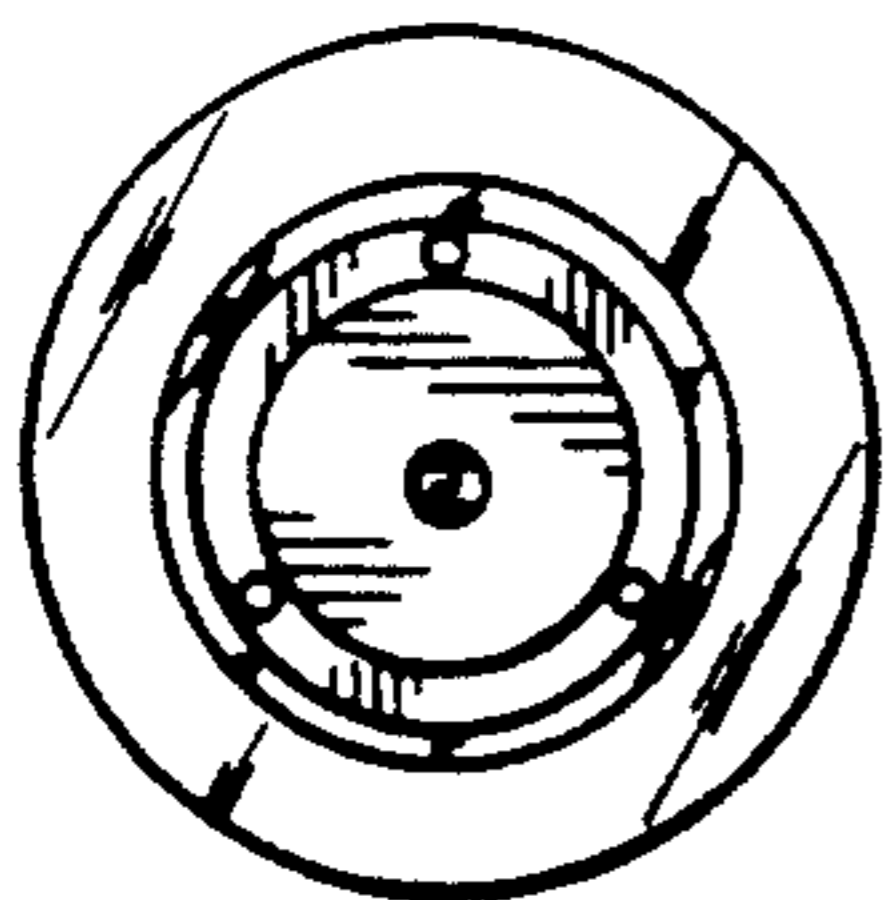

FIG. 6

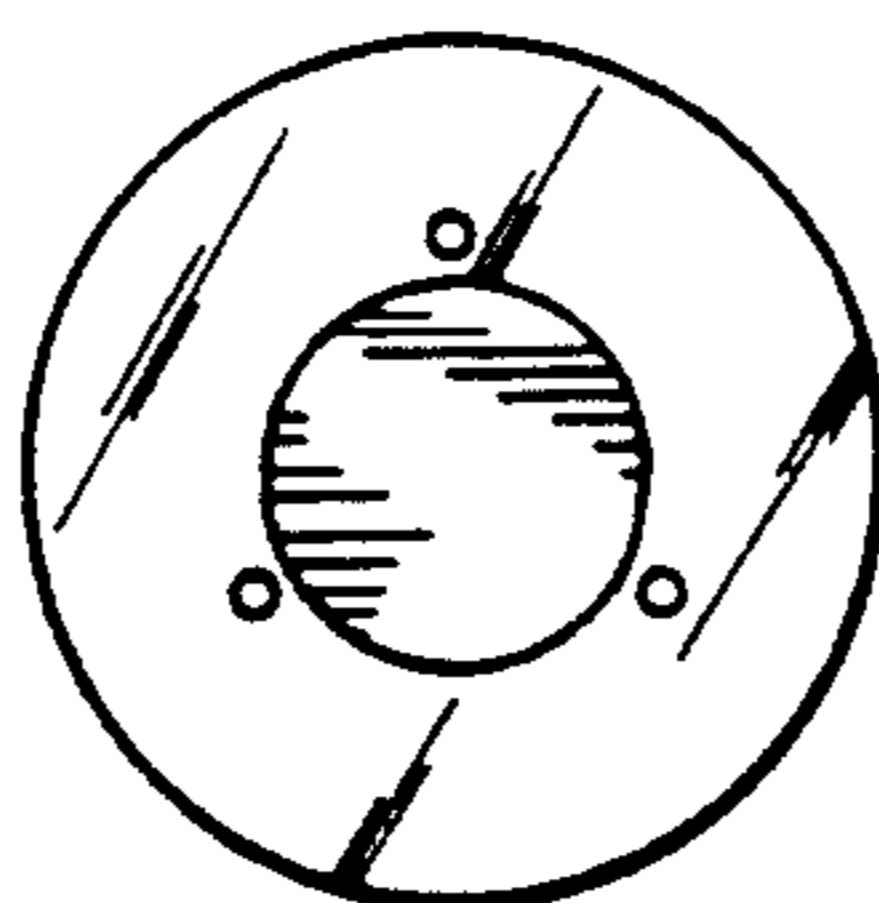

FIG. 8

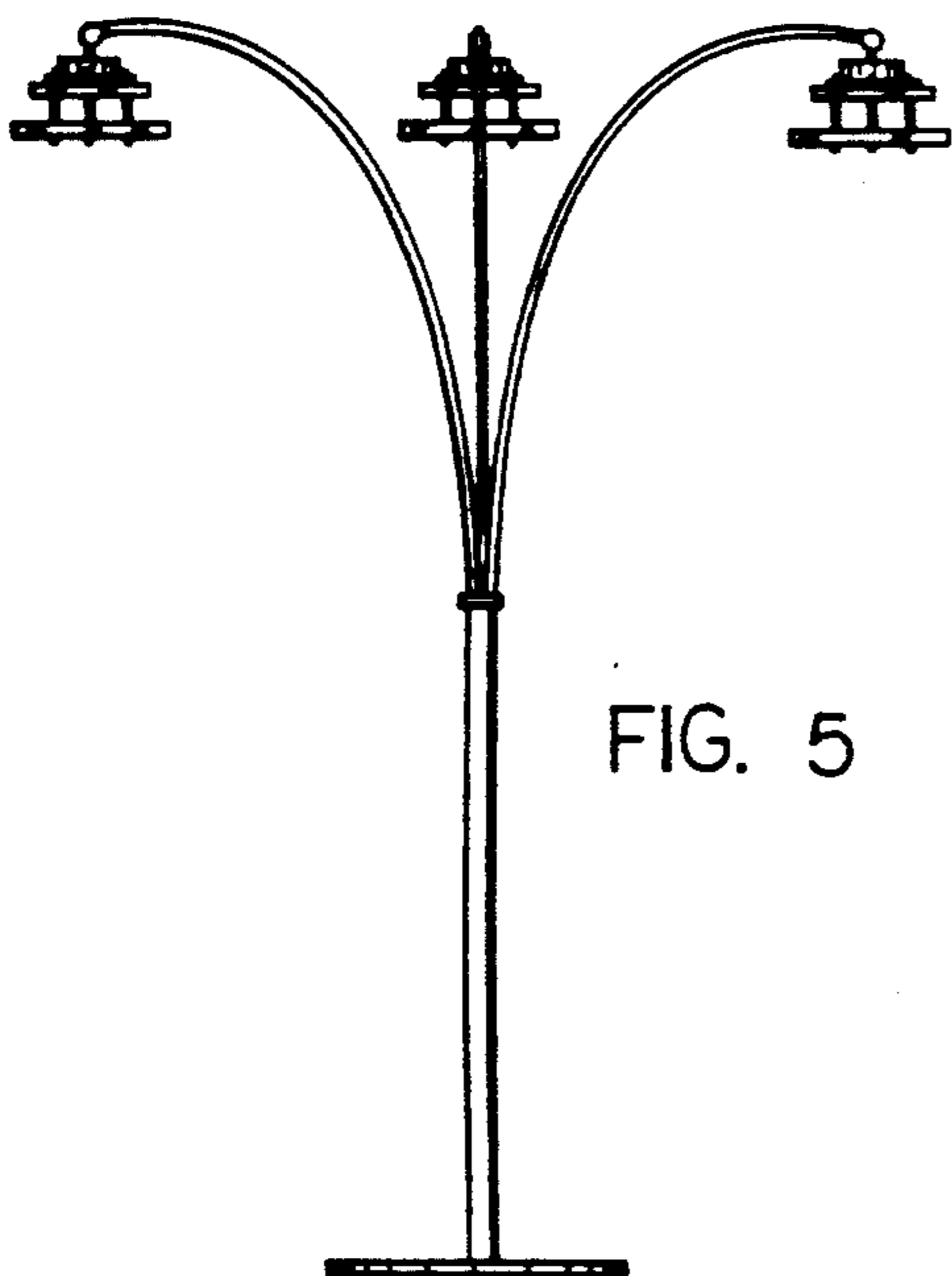

FIG. 5

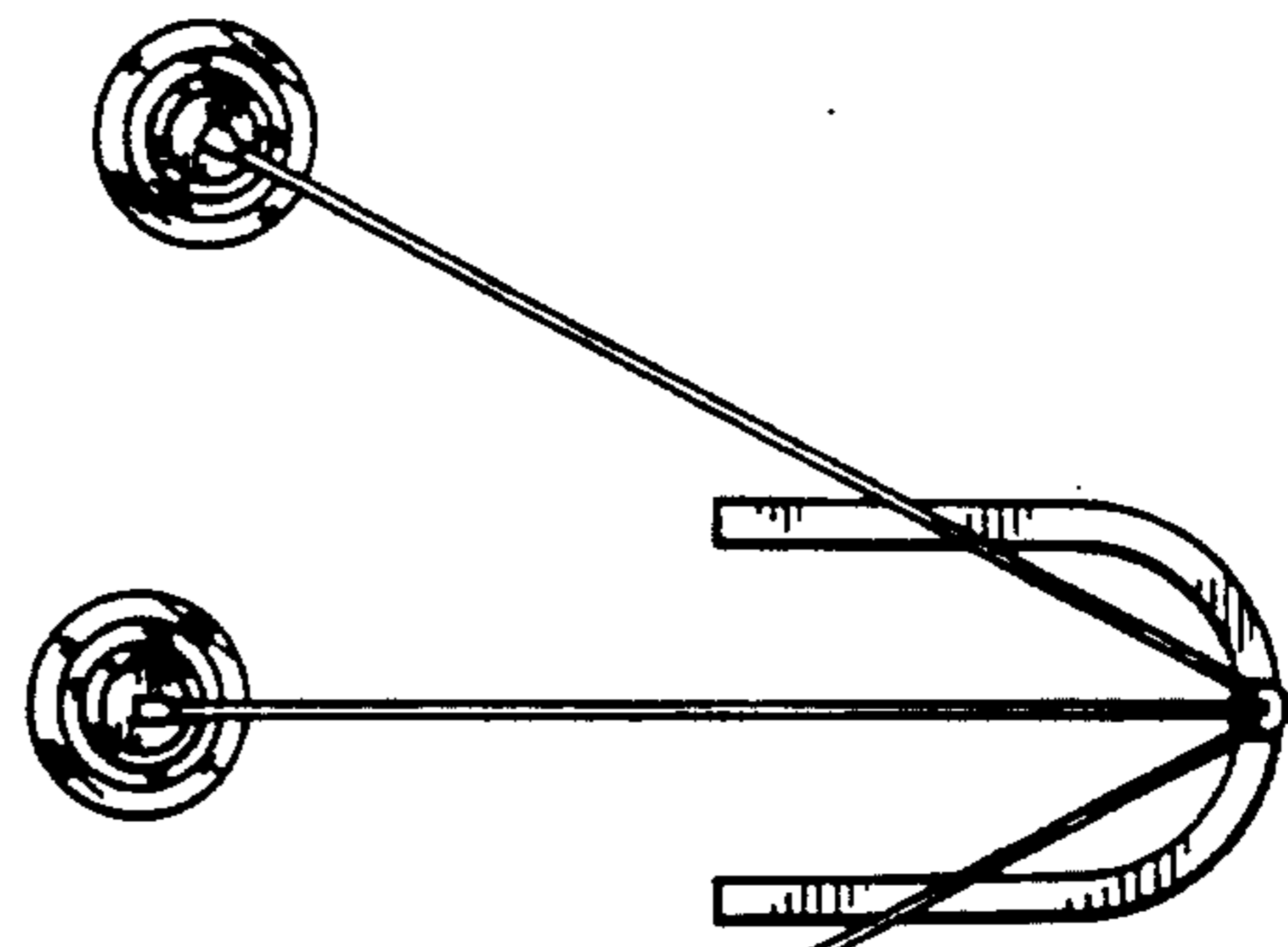

FIG. 3

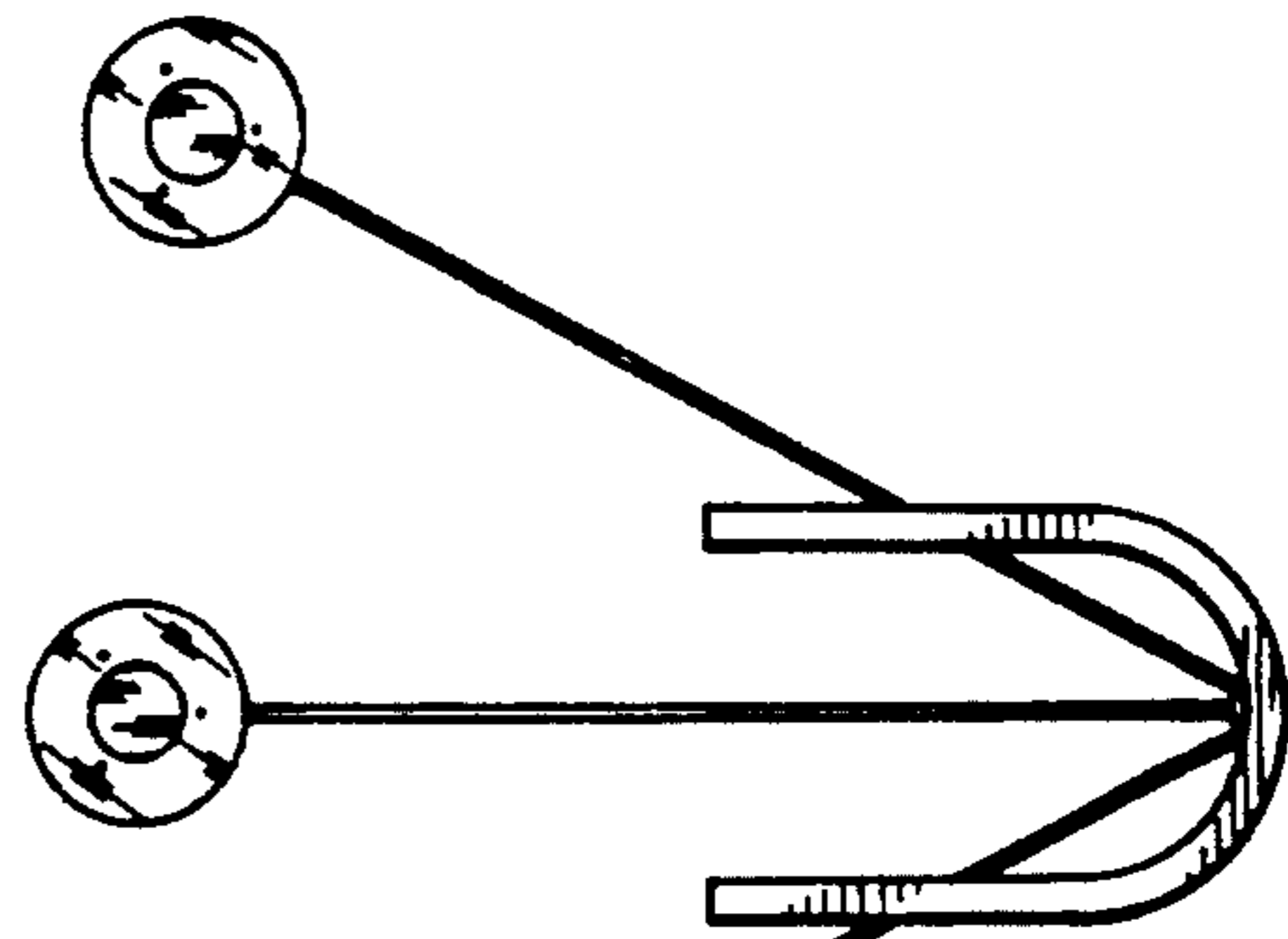

FIG. 4

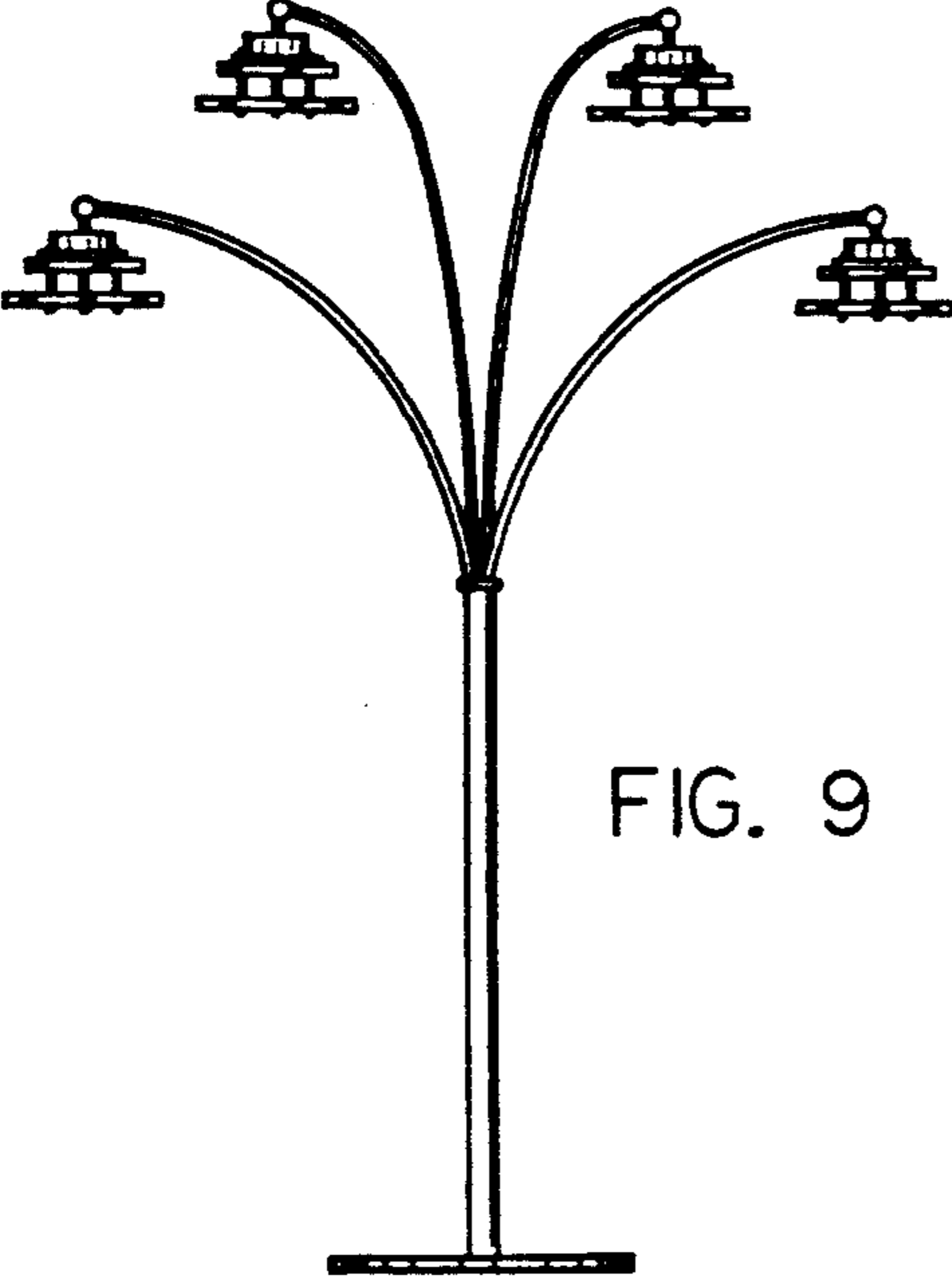

FIG. 9

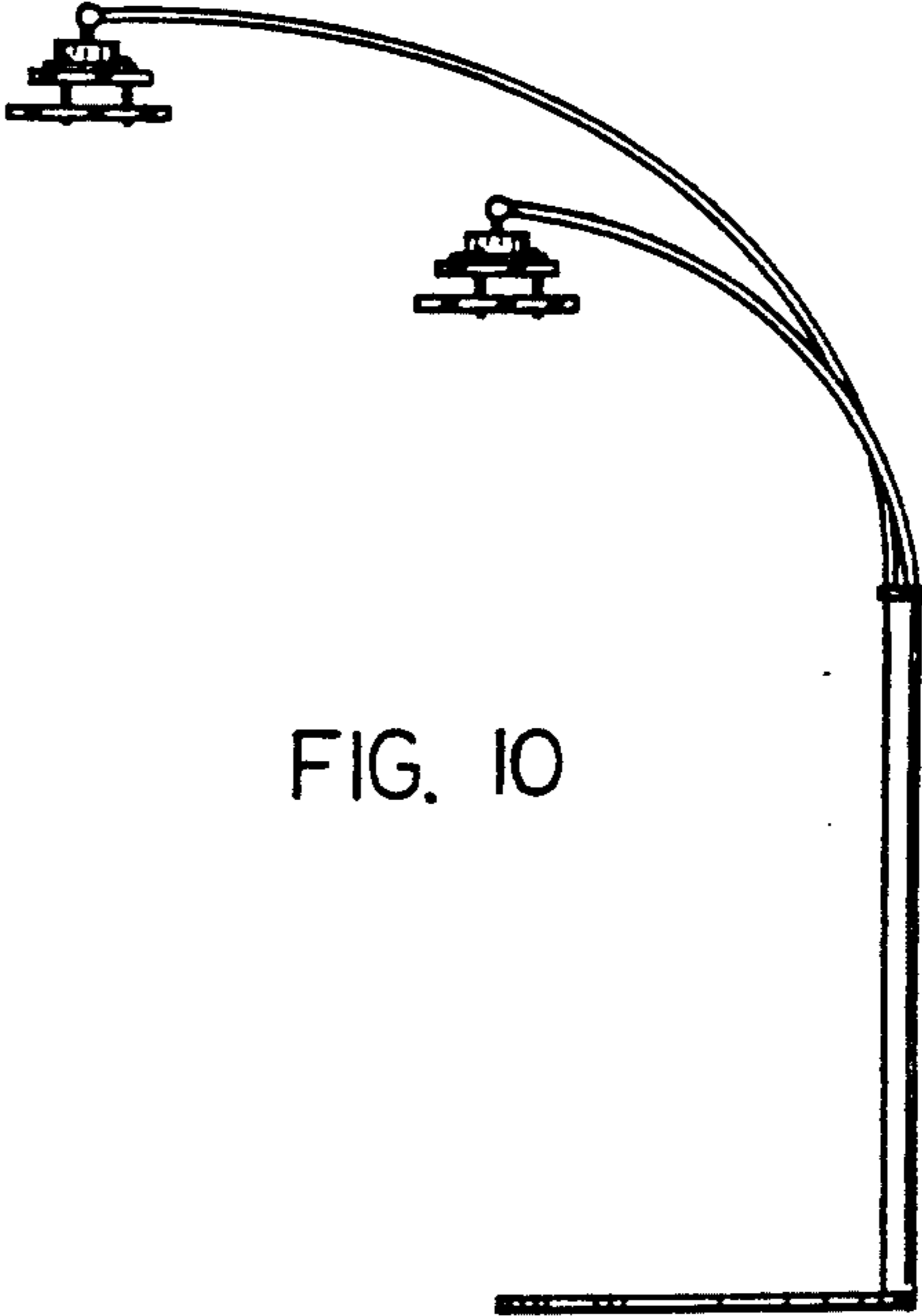

FIG. 10

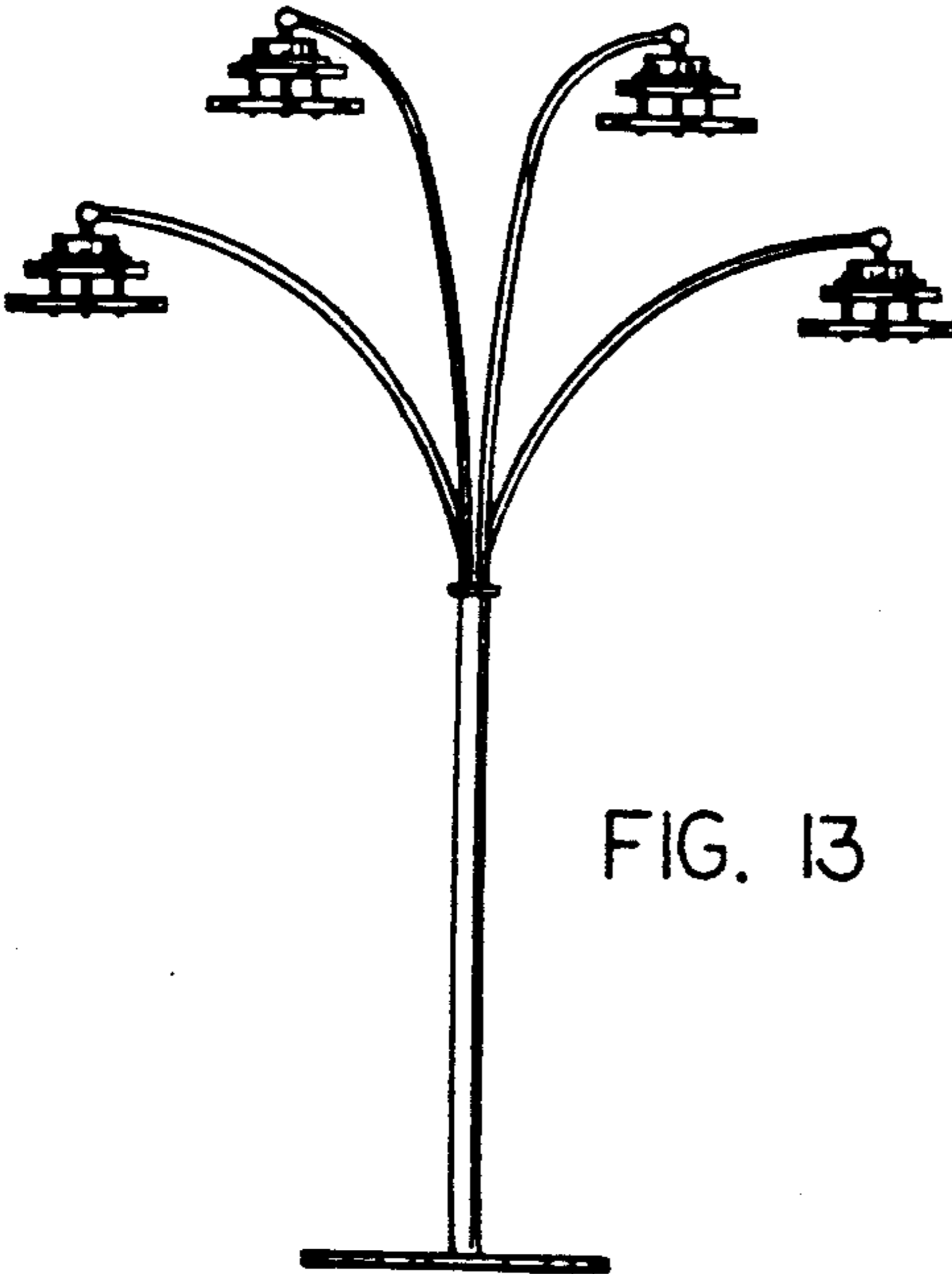

FIG. 13

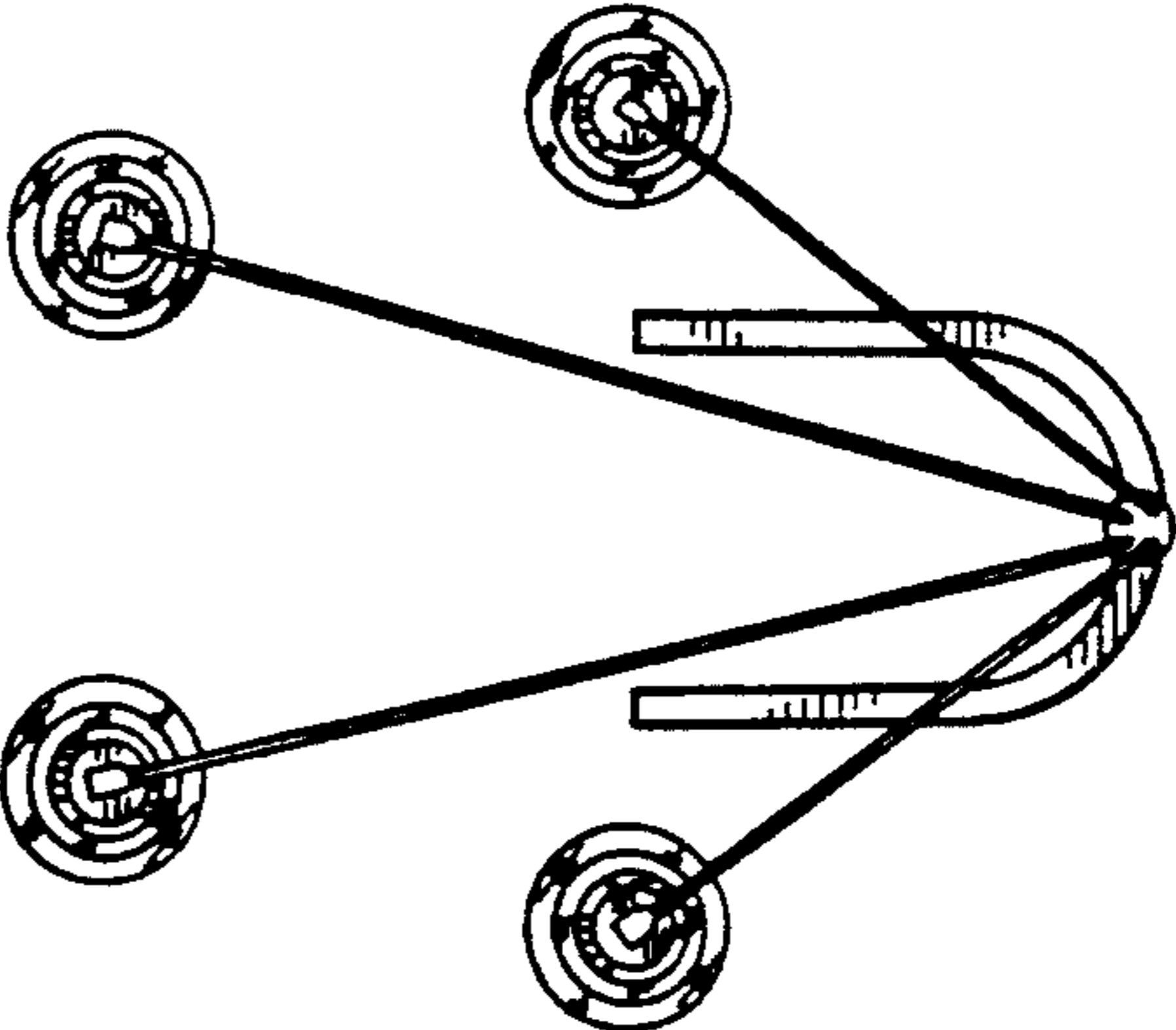

FIG. 11

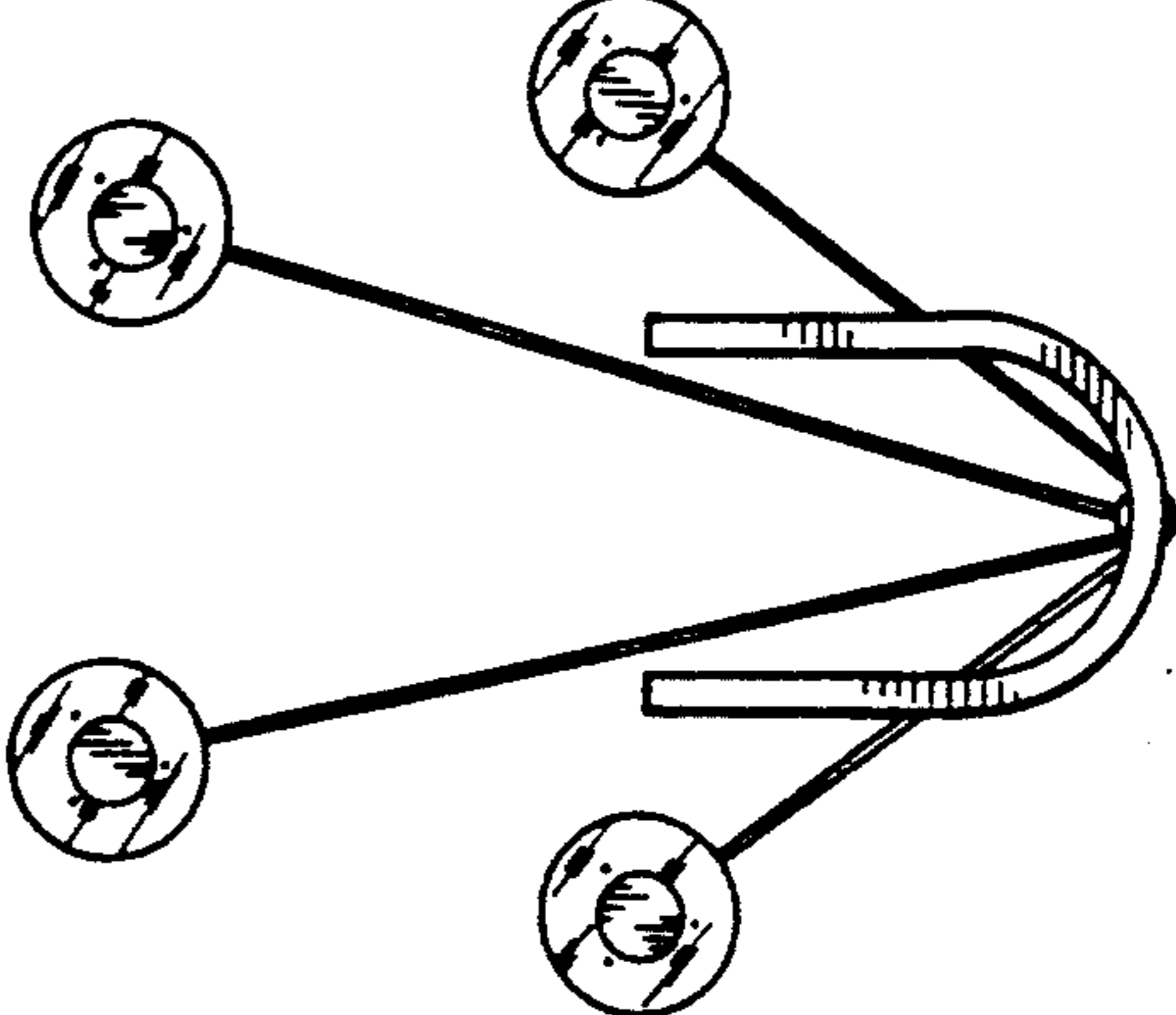

FIG. 12