



US00D347236S

United States Patent [19]

[11] Patent Number: **Des. 347,236**

Ooi et al.

[45] Date of Patent: **** May 24, 1994**

[54] **COMBINED VIDEO TAPE RECORDER AND CAMERA**

[75] Inventors: **Hiroshi Ooi; Seiji Kurokawa**, both of Tochigi, Japan

[73] Assignee: **Sharp Kabushiki Kaisha**, Osaka, Japan

[**] Term: **14 Years**

[21] Appl. No.: **7,281**

[22] Filed: **Apr. 21, 1993**

[30] **Foreign Application Priority Data**

Oct. 21, 1992 [JP] Japan 4-30974

[52] U.S. Cl. **D16/202**

[58] Field of Search 352/34, 242; 354/82, 354/288; 358/229, 906, 909; D16/200-206, 208

[56] **References Cited**

U.S. PATENT DOCUMENTS

D. 260,894 9/1981 Ellermeier D16/202

D. 288,811 3/1987 Kurokawa et al. D16/202
D. 337,341 7/1993 Masuda D16/202
D. 337,778 7/1993 Matsumura D16/202
4,625,243 11/1986 Takubo 358/229

Primary Examiner—Melvin B. Feifer
Assistant Examiner—Adir Aronovich
Attorney, Agent, or Firm—Nixon & Vanderhye

[57] **CLAIM**

The ornamental design for a combined video tape recorder and camera, as shown and described.

DESCRIPTION

FIG. 1 is a top, right side and rear perspective view of a combined video tape recorder and camera according to our design;

FIG. 2 is a top plan view thereof;

FIG. 3 is a bottom plan view thereof;

FIG. 4 is a left side elevational view thereof;

FIG. 5 is a right side elevational view thereof;

FIG. 6 is a front elevational view thereof; and,

FIG. 7 is a rear elevational view thereof.

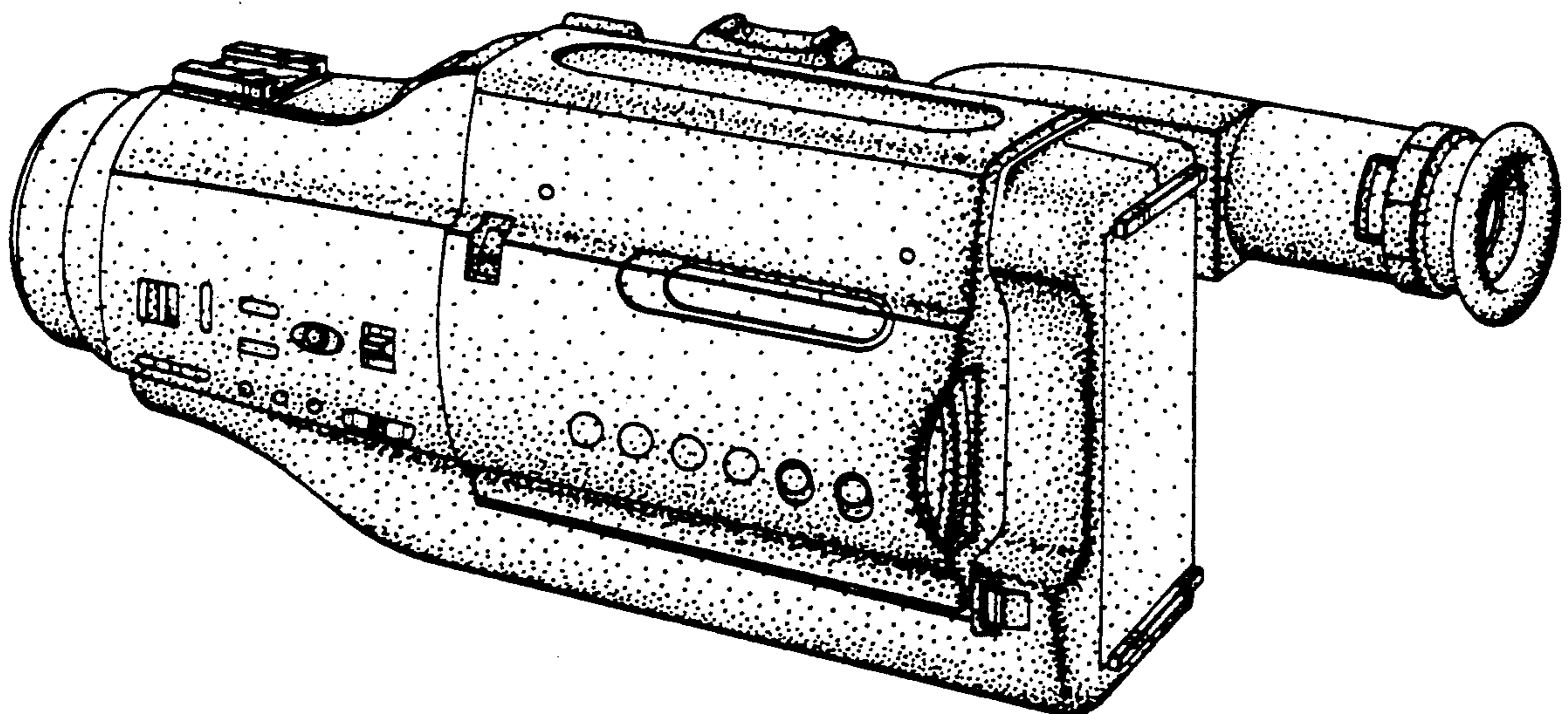

Fig. 1

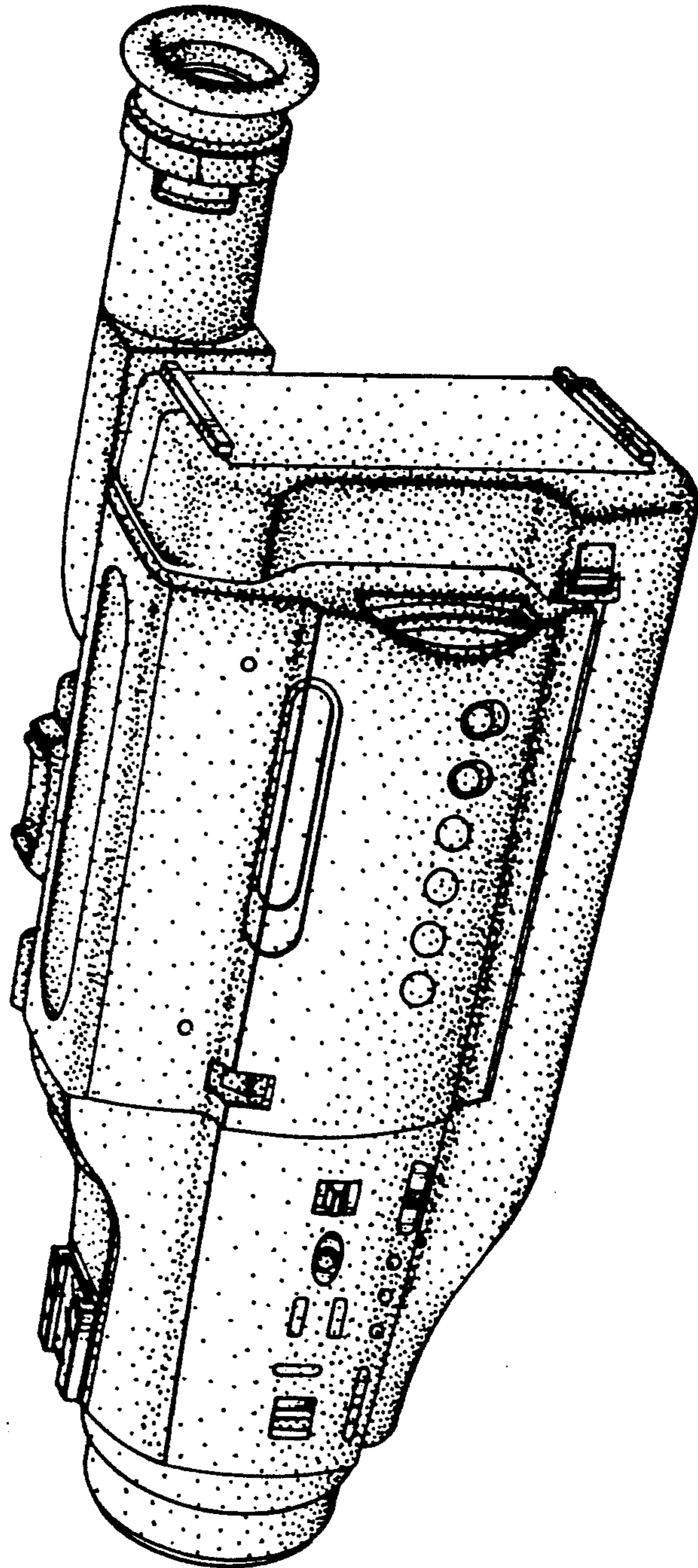

FIG. 2

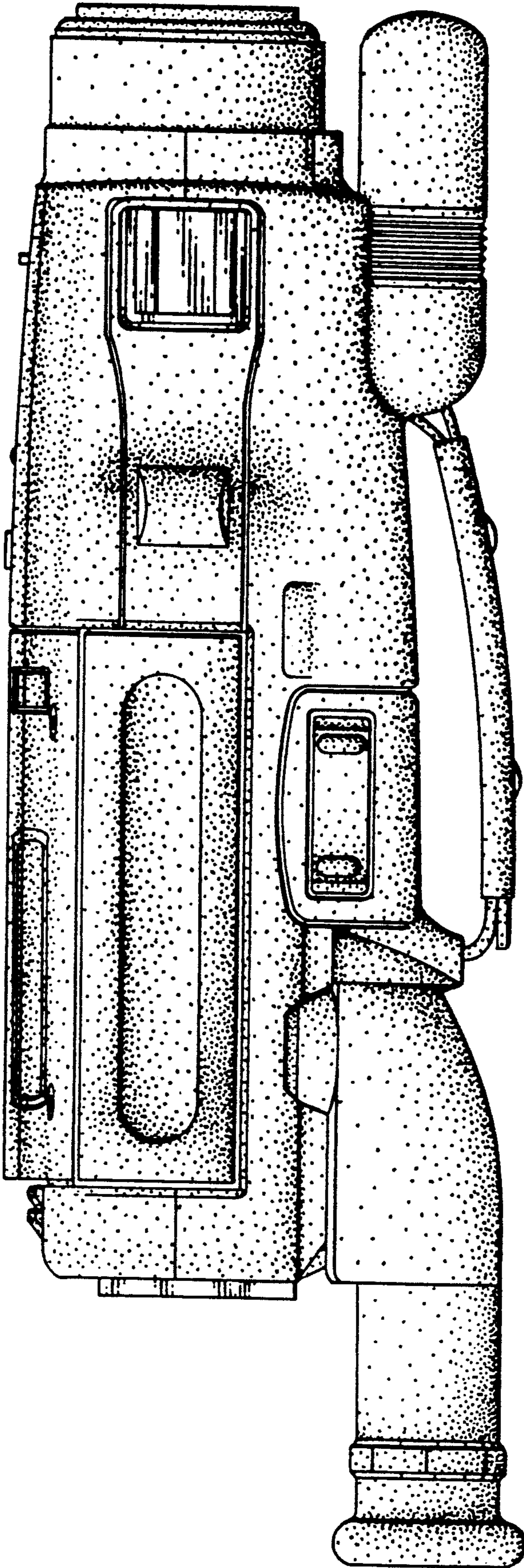

Fig. 3

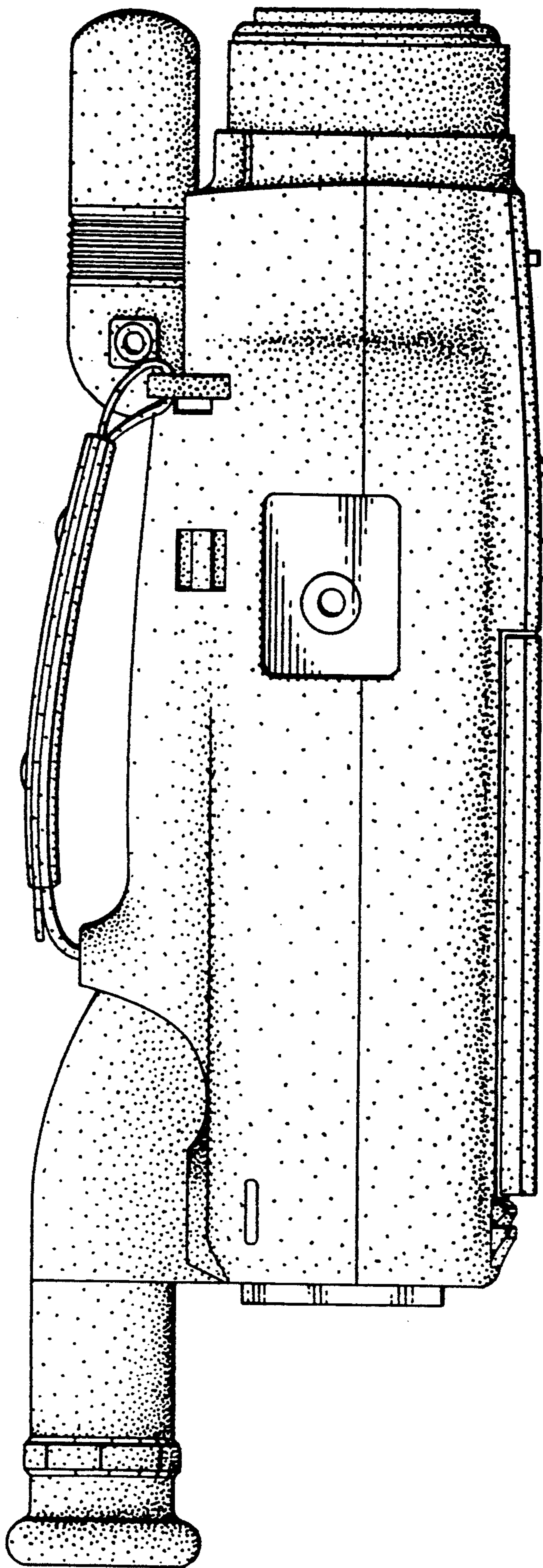

Fig. 4

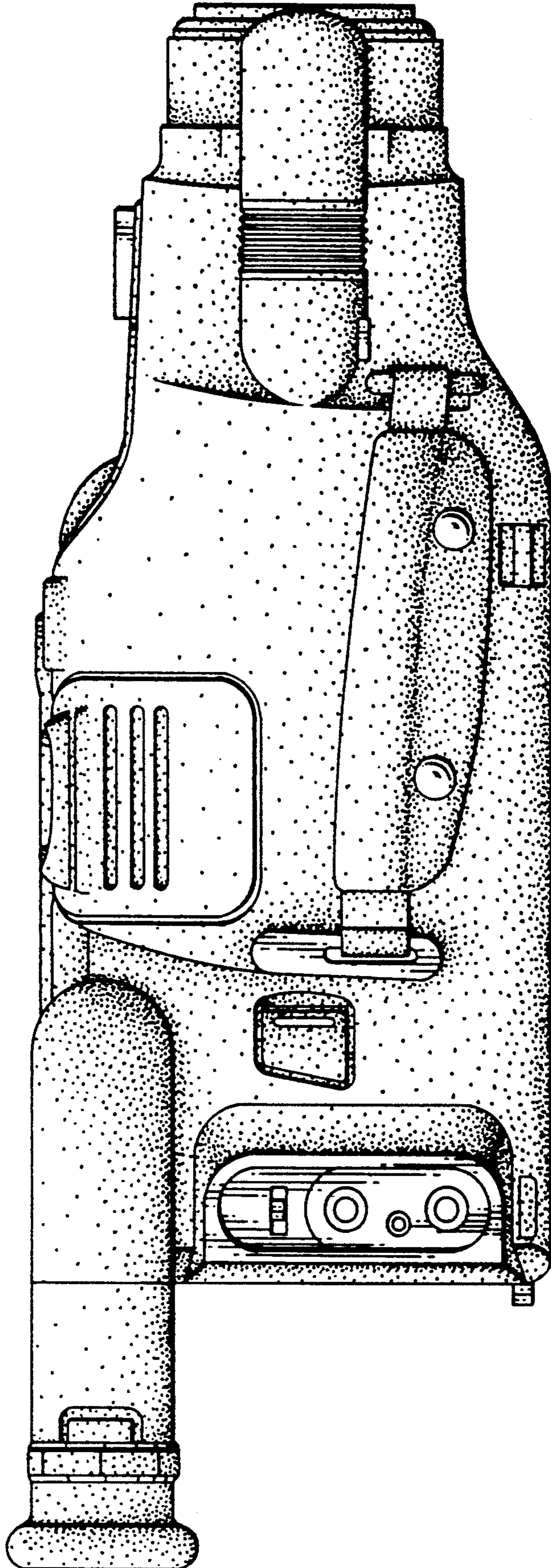

FIG. 5

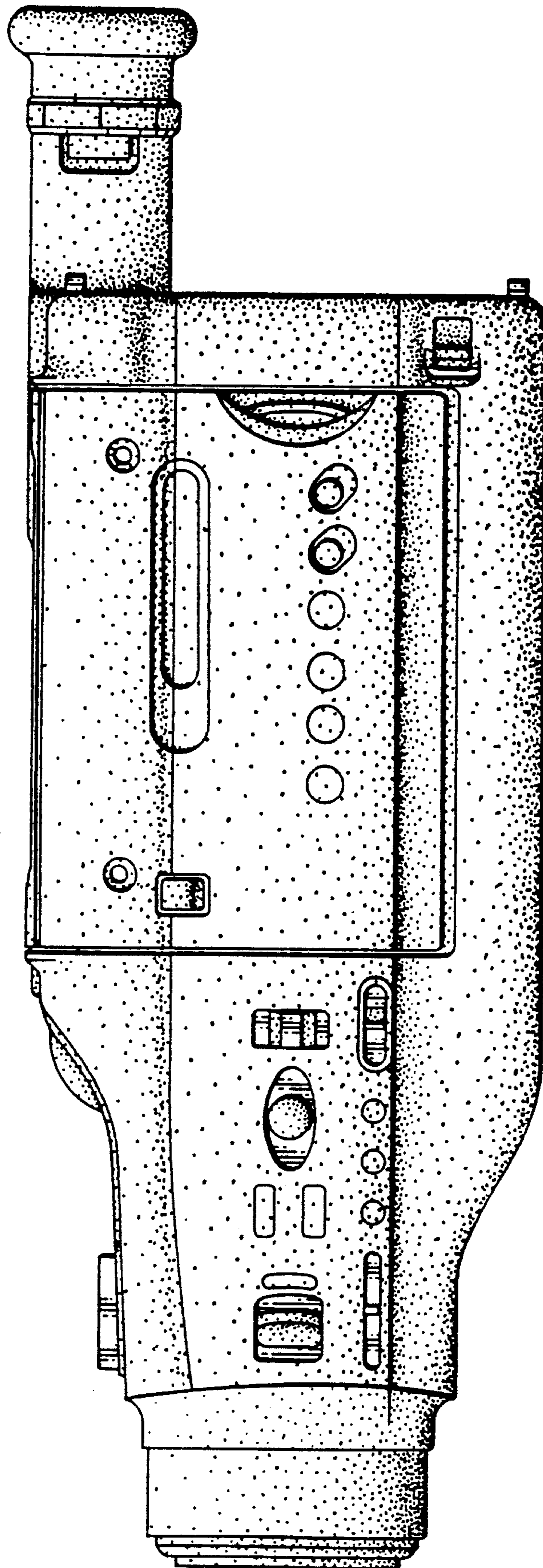

Fig. 7

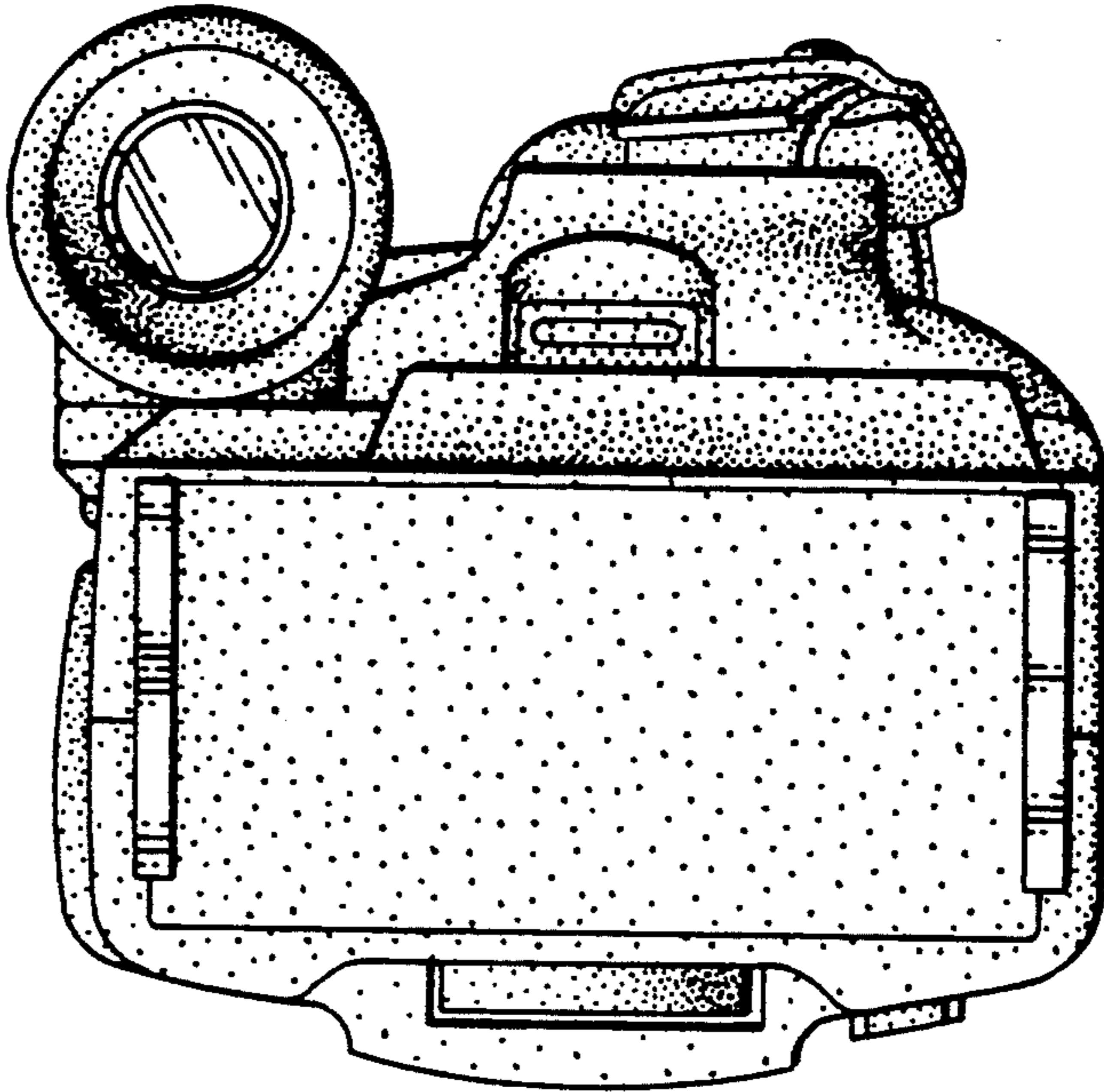

Fig. 6

