



US00D346966S

United States Patent [19]

[11] Patent Number: **Des. 346,966**

Oyanagi et al.

[45] Date of Patent: **** May 17, 1994**

[54] CLOCK WITH PICTURE FRAME

[75] Inventors: **Tsuyoshi Oyanagi; Itsuko Hirose,**
both of Tokyo, Japan

[73] Assignee: **Seikosha Co., Ltd.,** Japan

[**] Term: **14 Years**

[21] Appl. No.: **832,754**

[22] Filed: **Feb. 5, 1992**

[52] U.S. Cl. **D10/2; D10/18**

[58] Field of Search **368/10, 276, 277, 285;**
D6/300, 302; D10/1-40, 122-132

[56] References Cited

U.S. PATENT DOCUMENTS

- D. 333,271 2/1993 Erlichman D10/18
- D. 337,529 7/1993 Shimamura D10/18
- D. 337,727 7/1993 Benton D10/18

OTHER PUBLICATIONS

European Jeweler -Feb. 1981 p. 950-clock at bottom left.

Primary Examiner—Nelson C. Holtje
Attorney, Agent, or Firm—Bruce L. Adams; Van C. Wilks

[57] CLAIM

The ornamental design for a clock with picture frame, as shown and described.

DESCRIPTION

FIG. 1 is a front elevational view of a clock with picture frame showing our new design;
 FIG. 2 is a rear elevational view thereof;
 FIG. 3 is a top plan view thereof, the bottom being the same in appearance as the top;
 FIG. 4 is a left side elevational view thereof;
 FIG. 5 is a right side elevational view thereof; and,
 FIG. 6 is a front elevational view with a broken line showing of a representative photograph which is environmental only and forms no part of the claimed design.

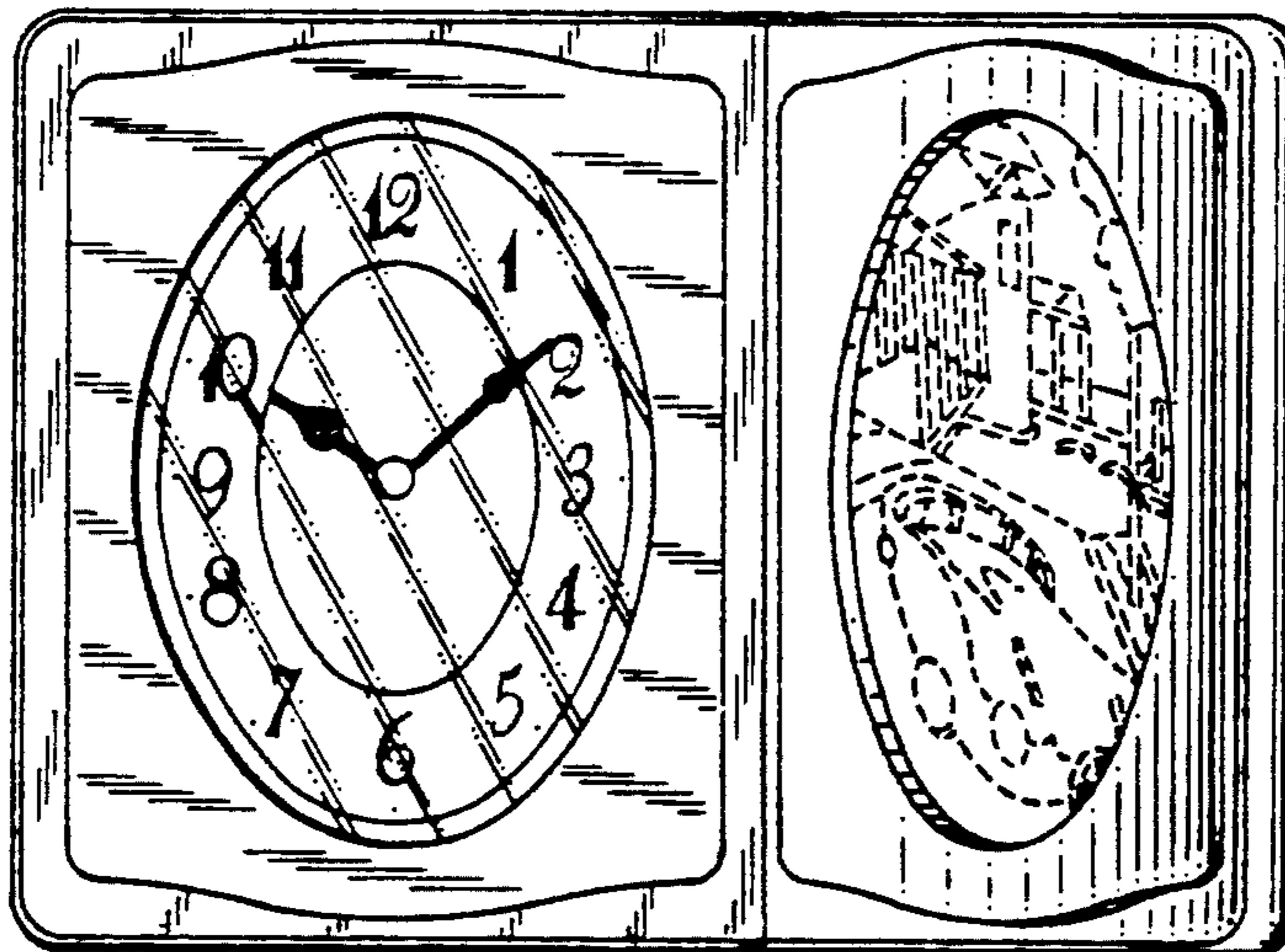

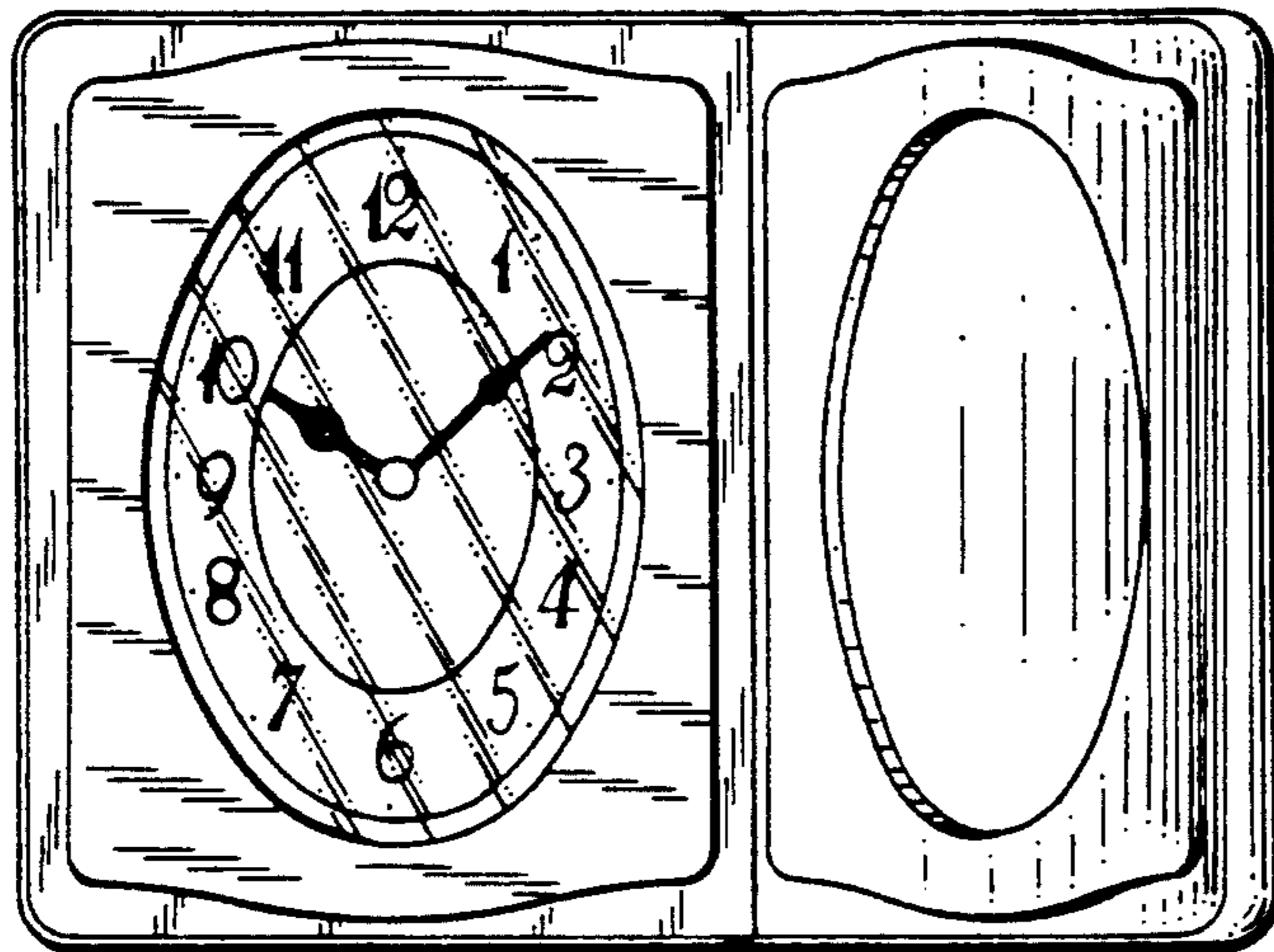

FIG. 1

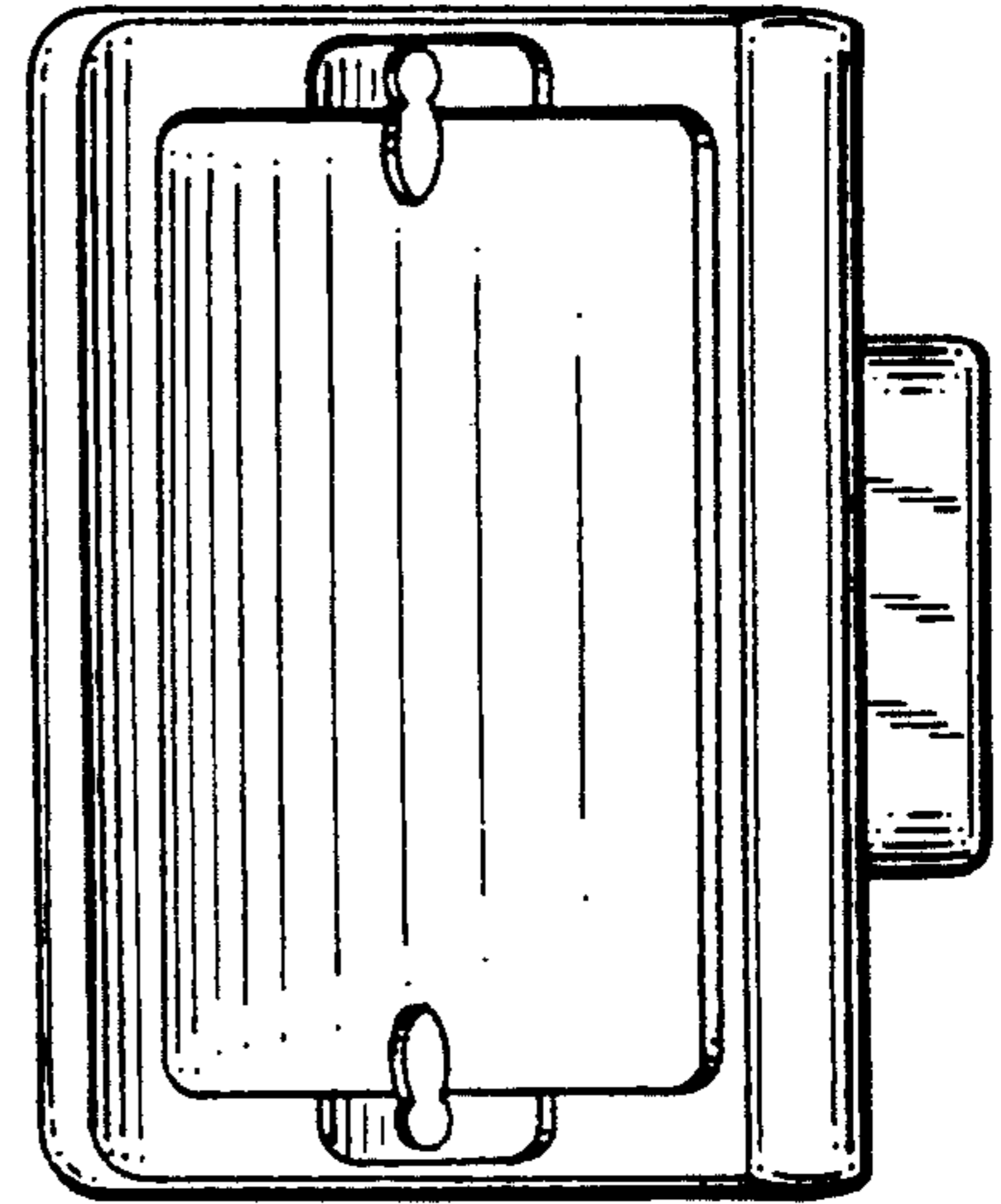

FIG. 5

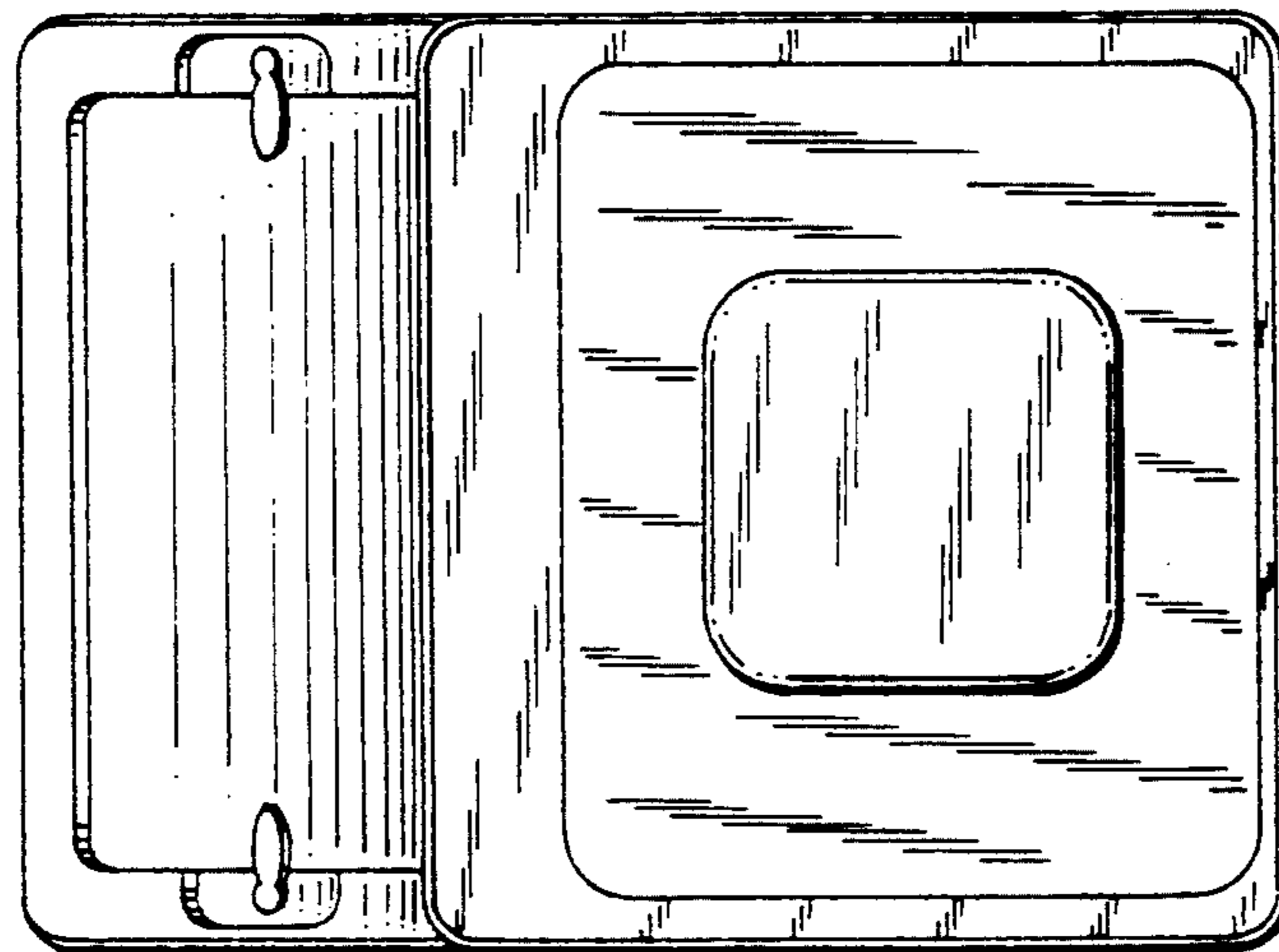

FIG. 2

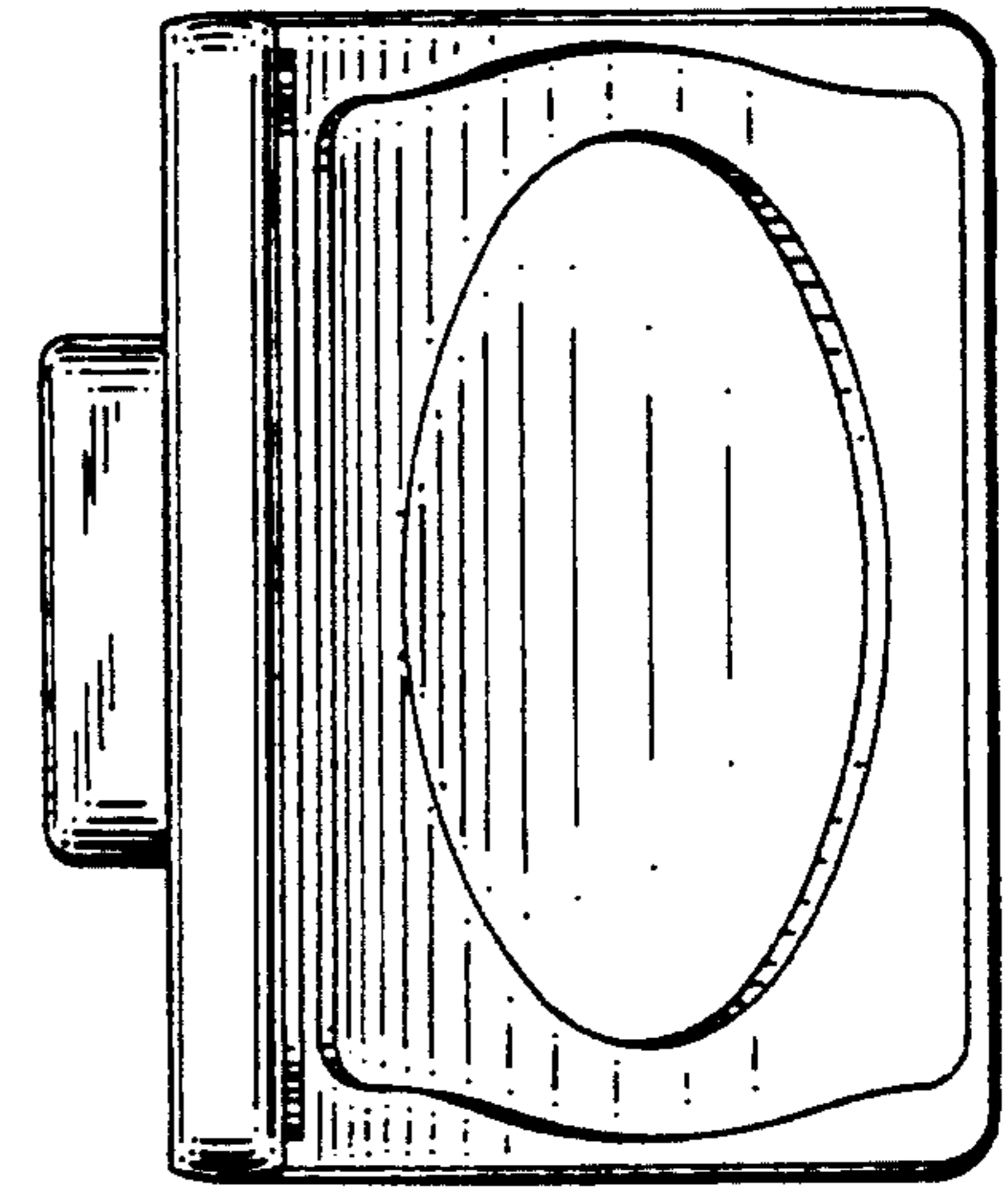

FIG. 4

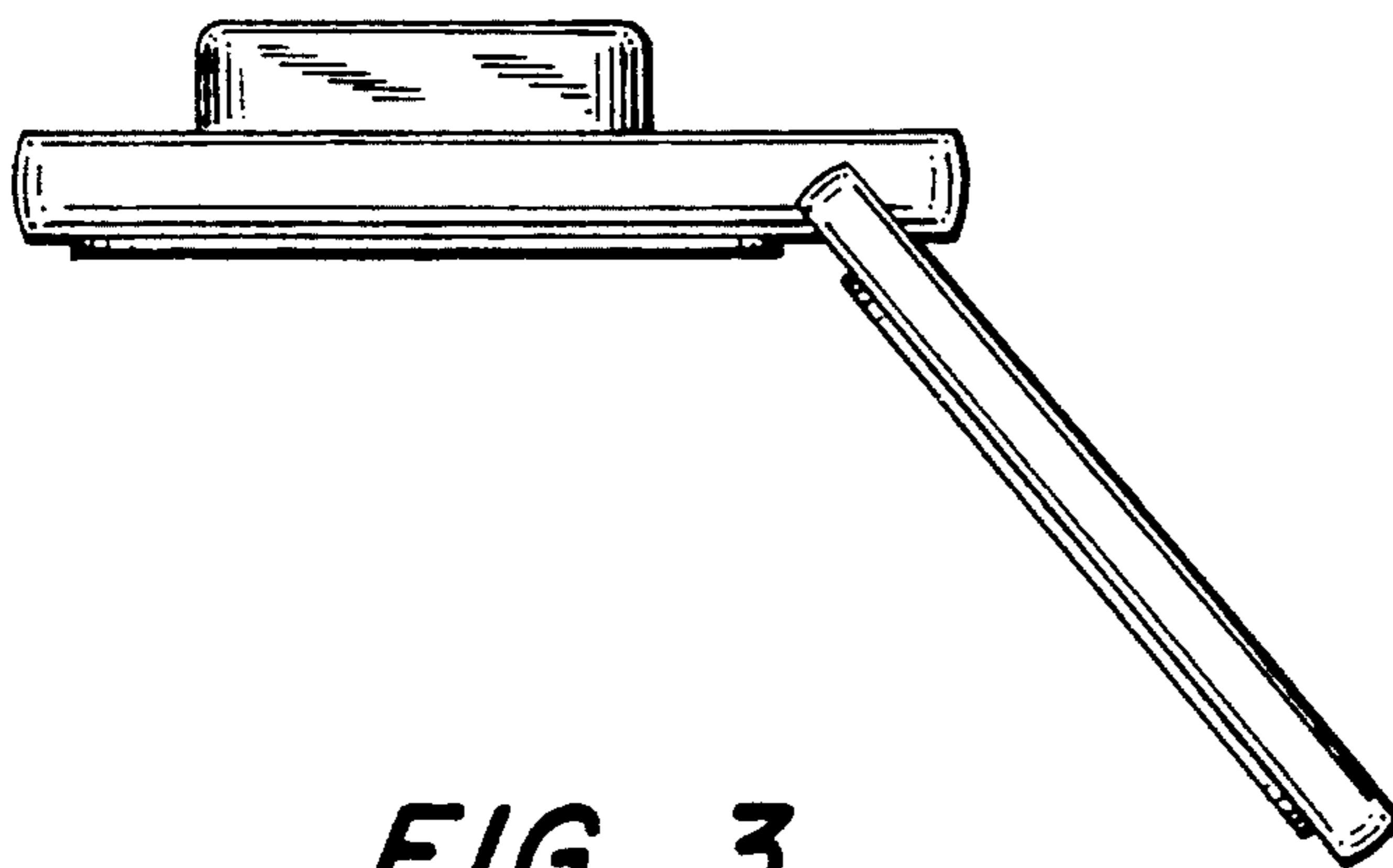

FIG. 3

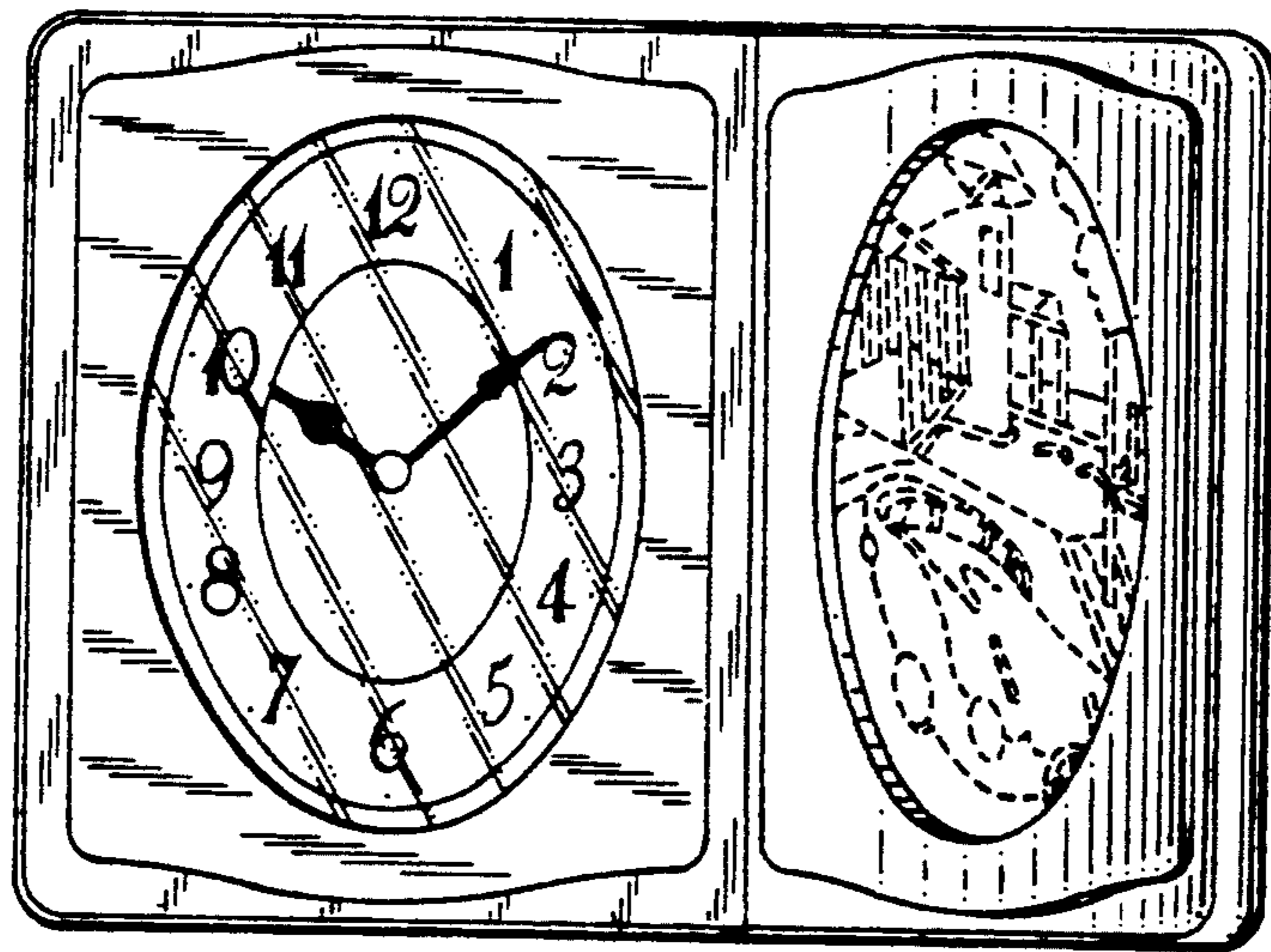

FIG. 6