



US00D346948S

United States Patent [19]

[11] Patent Number: **Des. 346,948**

Pedlar

[45] Date of Patent: **** May 17, 1994**

[54] **PADLOCK**

5,042,277 8/1991 Jenn-Rong 70/28
5,119,650 6/1992 Lo 70/25

[75] Inventor: **Roger Pedlar, London, England**

Primary Examiner—Brian N. Vinson
Attorney, Agent, or Firm—Gregory W. O'Connor

[73] Assignee: **Samsonite Corporation, Denver, Colo.**

[**] Term: **14 Years**

[57] **CLAIM**

[21] Appl. No.: **877,063**

The ornamental design for a padlock, as shown and described.

[22] Filed: **May 1, 1992**

DESCRIPTION

[52] U.S. Cl. **D8/334**

FIG. 1 is a perspective view of a padlock embodying my new design, as viewed from the lower righthand corner;

[58] Field of Search **D8/333-334;**
70/20-22, 24-26, 27-29, 35, 41-44

FIG. 2 is a bottom plan view of the padlock shown in FIG. 1;

[56] **References Cited**

U.S. PATENT DOCUMENTS

D. 48,604	2/1916	Oberholtzer	D8/334
D. 294,453	3/1988	Ling	D8/334
1,924,987	8/1933	Furino	70/26
3,736,781	6/1973	Foote	70/20 X

FIG. 3 is a top plan view thereof;

FIG. 4 is a front side view thereof;

FIG. 5 is a back side view thereof;

FIG. 6 is a bottom end view thereof; and,

FIG. 7 is a top end view thereof.

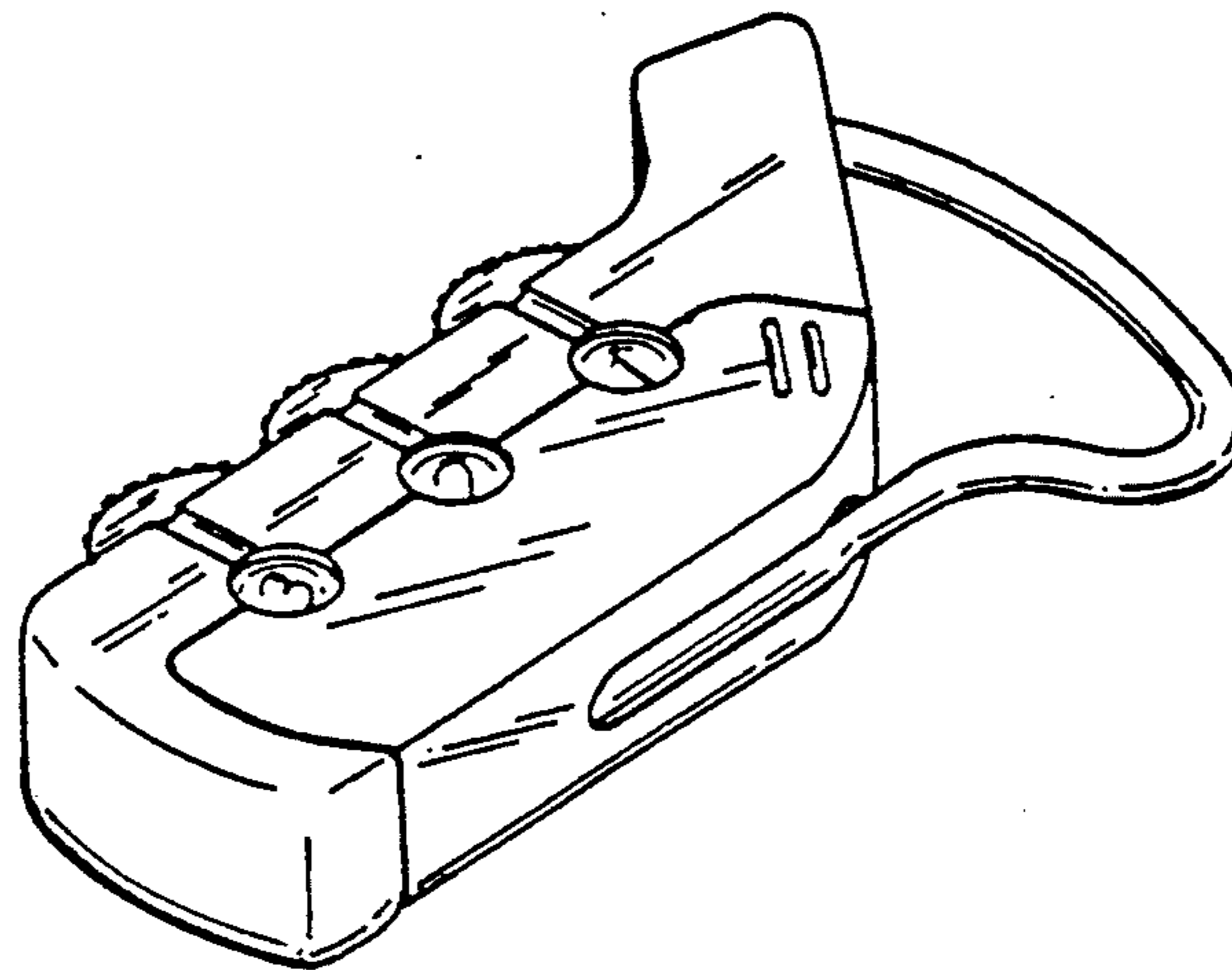

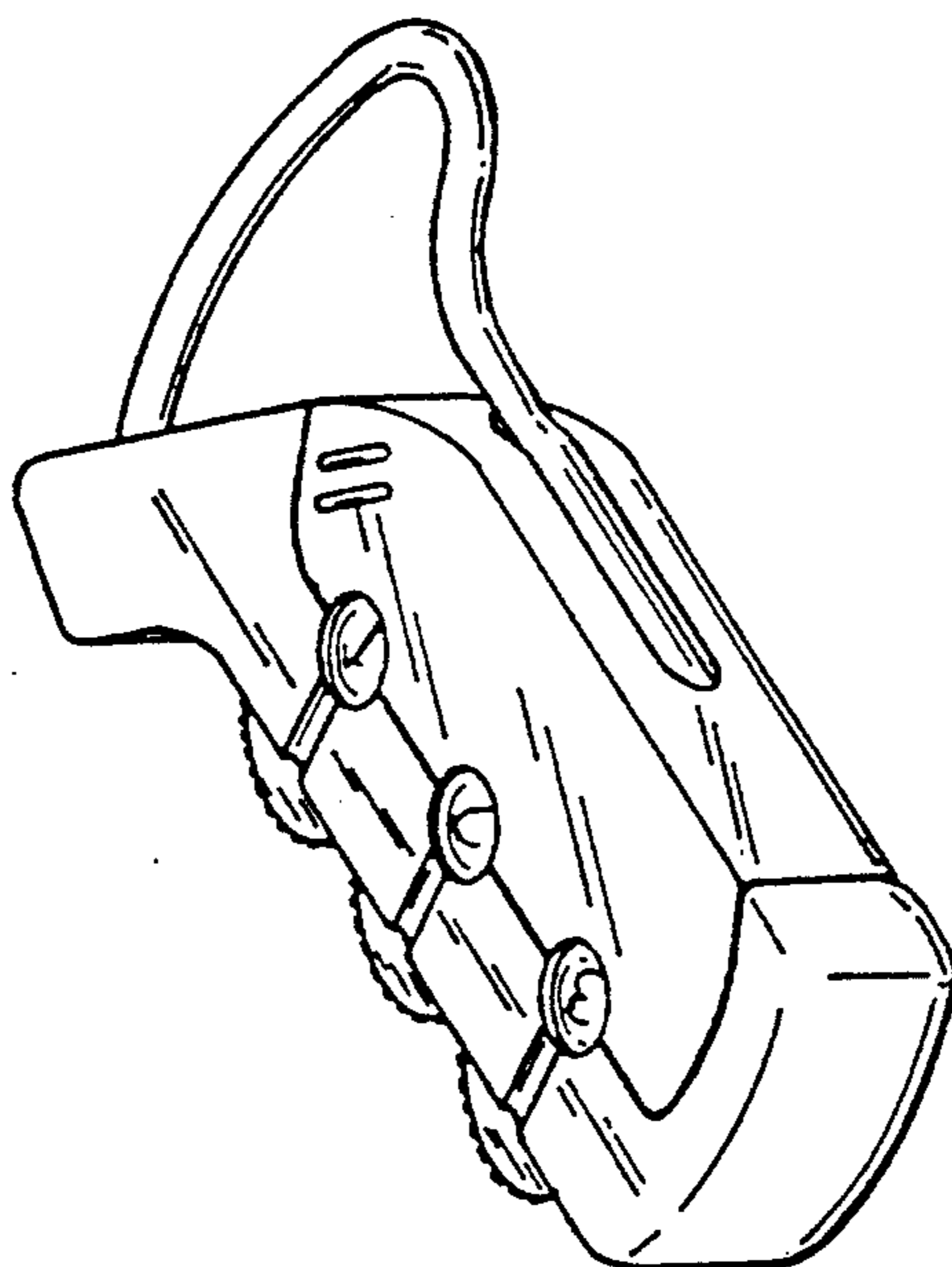

FIG. 1

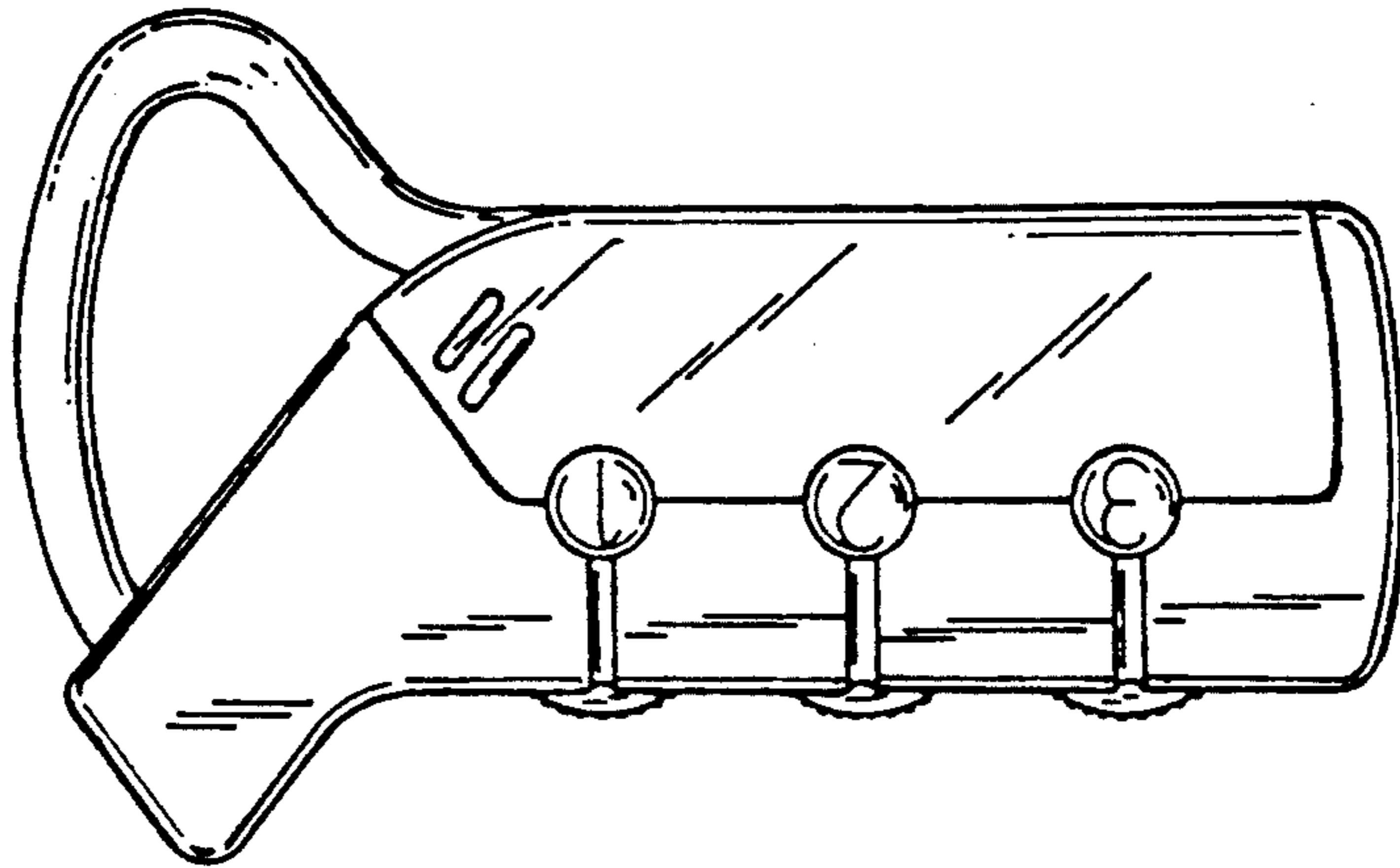

FIG. 3

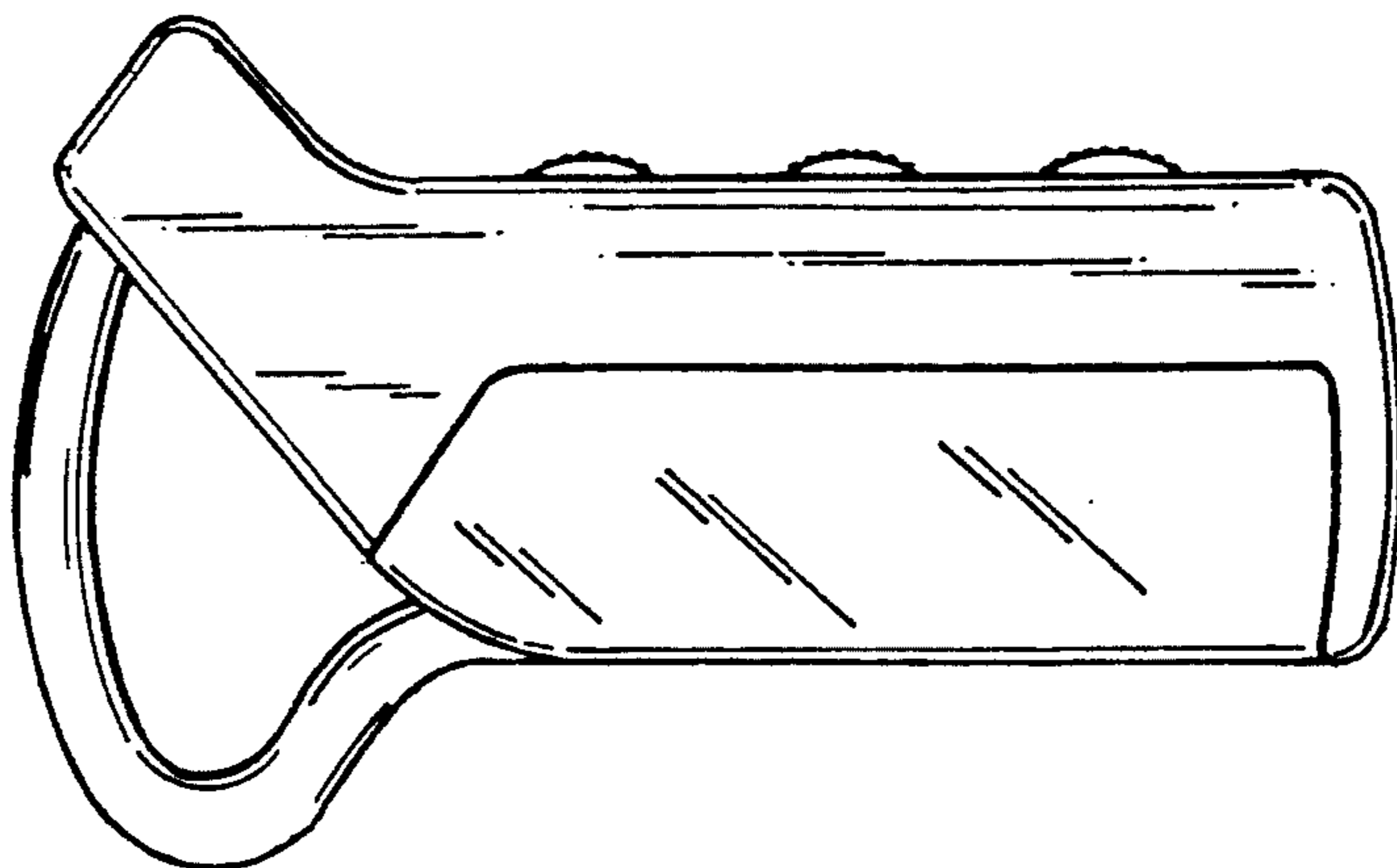

FIG. 2

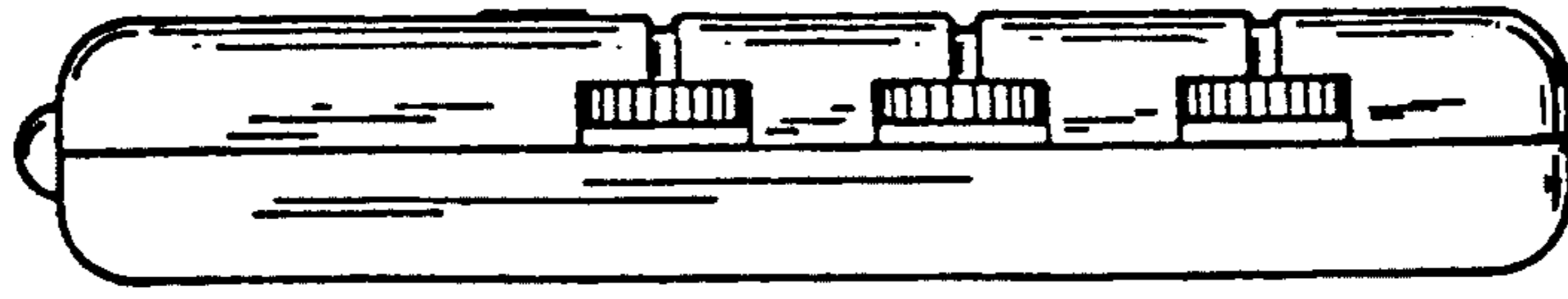

FIG. 5

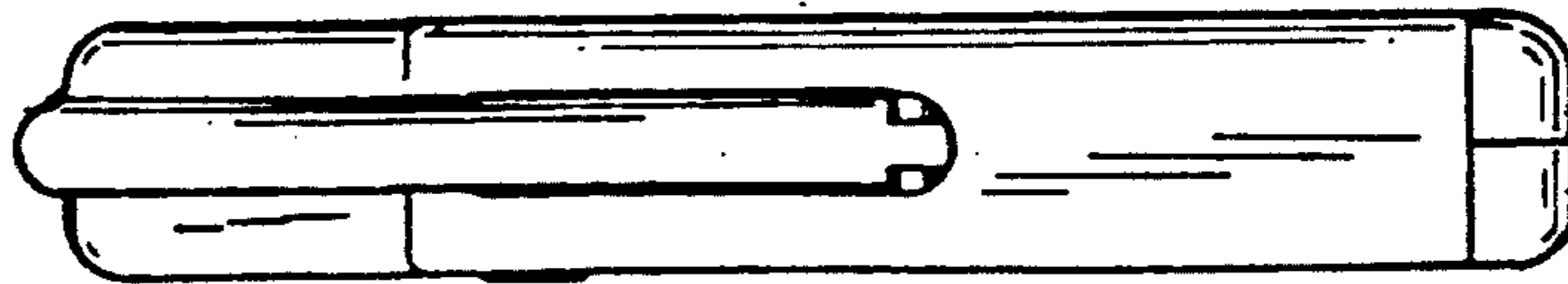

FIG. 4



FIG. 7

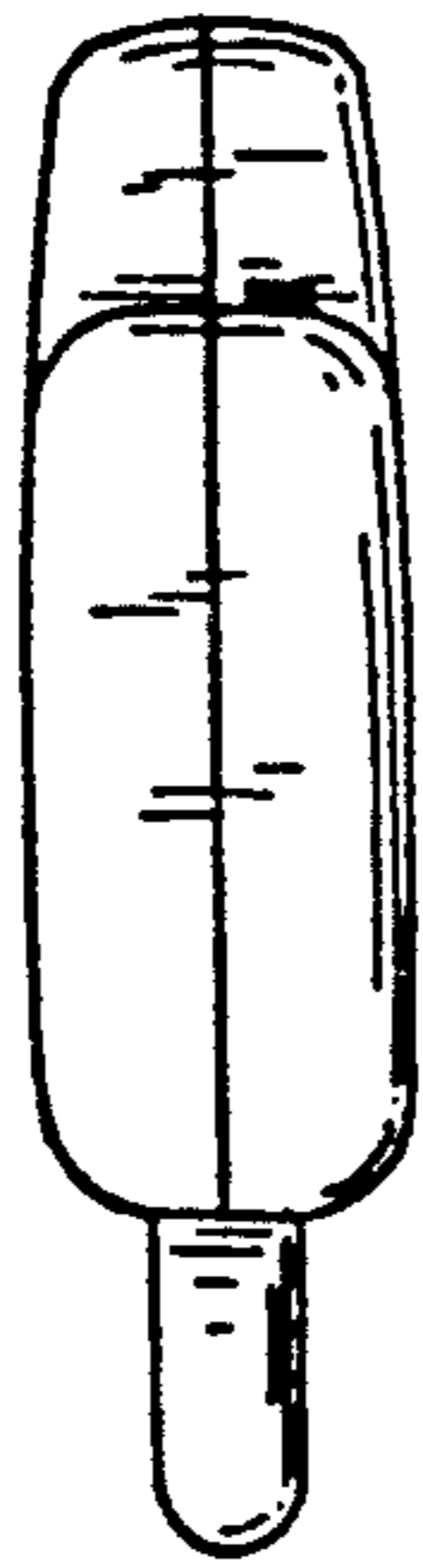

FIG. 6