



US00D346917S

United States Patent [19]
Weltman

[11] **Patent Number: Des. 346,917**
[45] **Date of Patent: ** May 17, 1994**

[54] **TABLE**

[75] **Inventor: Judith F. Weltman, Chesterfield, Mo.**

[73] **Assignee: Judith F. Weltman, Inc.,
Chesterfield, Mo.**

[**] **Term: 14 Years**

[21] **Appl. No.: 923,347**

[22] **Filed: Jul. 31, 1992**

[52] **U.S. Cl. D6/451; D6/484**

[58] **Field of Search D6/480, 482-489,
D6/495, 497, 450, 451; 108/150, 153, 161**

[56] **References Cited**

U.S. PATENT DOCUMENTS

- D. 233,872 12/1974 Jester D6/484
- D. 259,526 6/1981 Ralston, Jr. D6/450
- D. 287,078 12/1986 Bowsheer D6/450

OTHER PUBLICATIONS

DIA ©1988, p. 14, table #630-4 at lower right-Normandy.

Primary Examiner—Nelson C. Holtje
Assistant Examiner—J. E. Seeger
Attorney, Agent, or Firm—Senniger, Powers, Leavitt & Roedel

[57] **CLAIM**

The ornamental design for table, as shown and described.

DESCRIPTION

FIG. 1 is a front elevational view of a table showing my new design, the rear being a mirror image thereof; FIG. 2 is a right side elevational view thereof, the left side being a mirror image thereof; FIG. 3 is a top plan view thereof; FIG. 4 is a bottom plan view thereof; FIG. 5 is a front elevational view showing a table of a second embodiment, the rear elevational view being a mirror image thereof; FIG. 6 is a right side elevational view of the table shown in FIG. 5, the left side elevational view being a mirror image thereof; and, FIG. 7 is a perspective view of the embodiment shown in FIGS. 1-4.

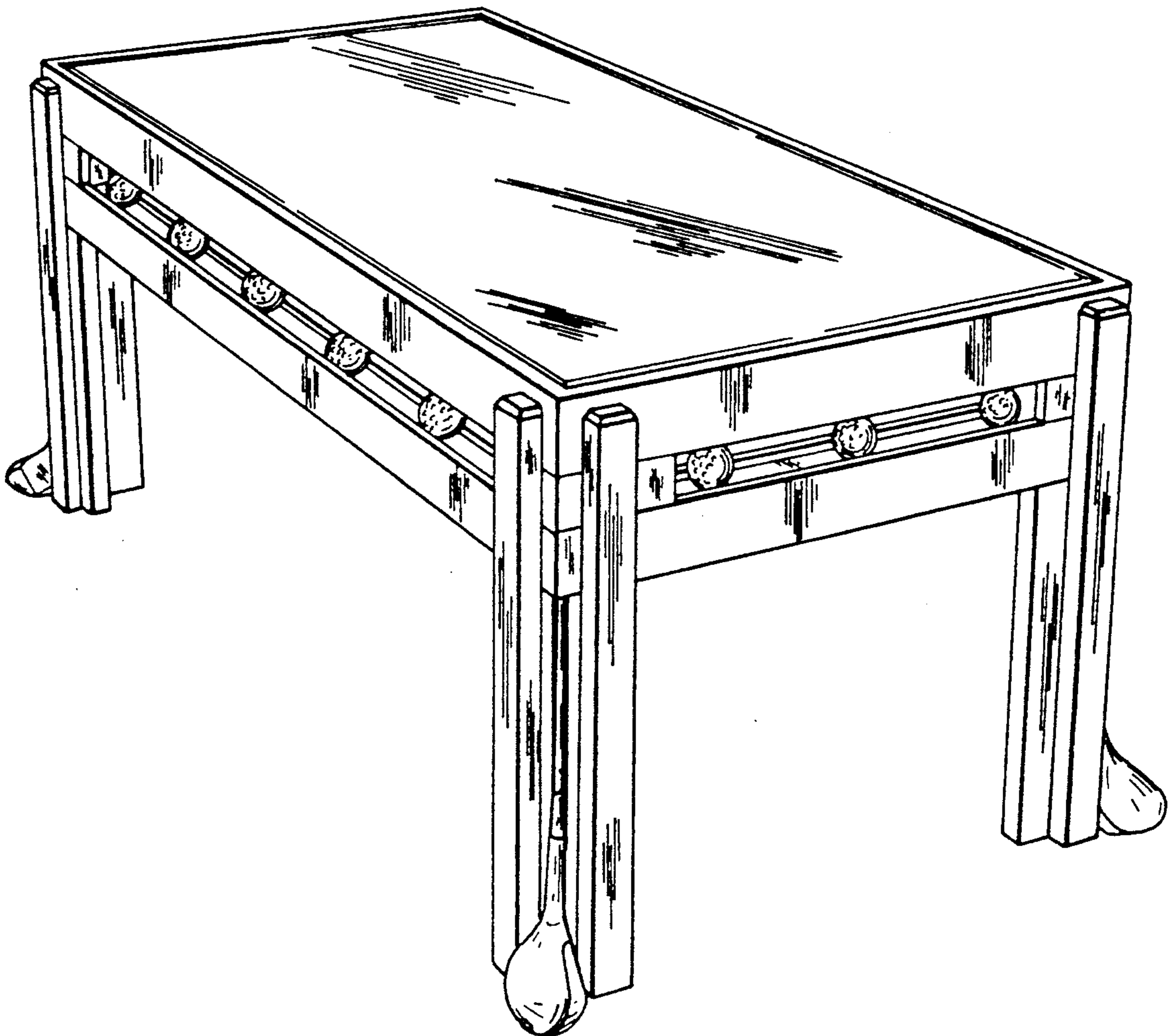

FIG. 1

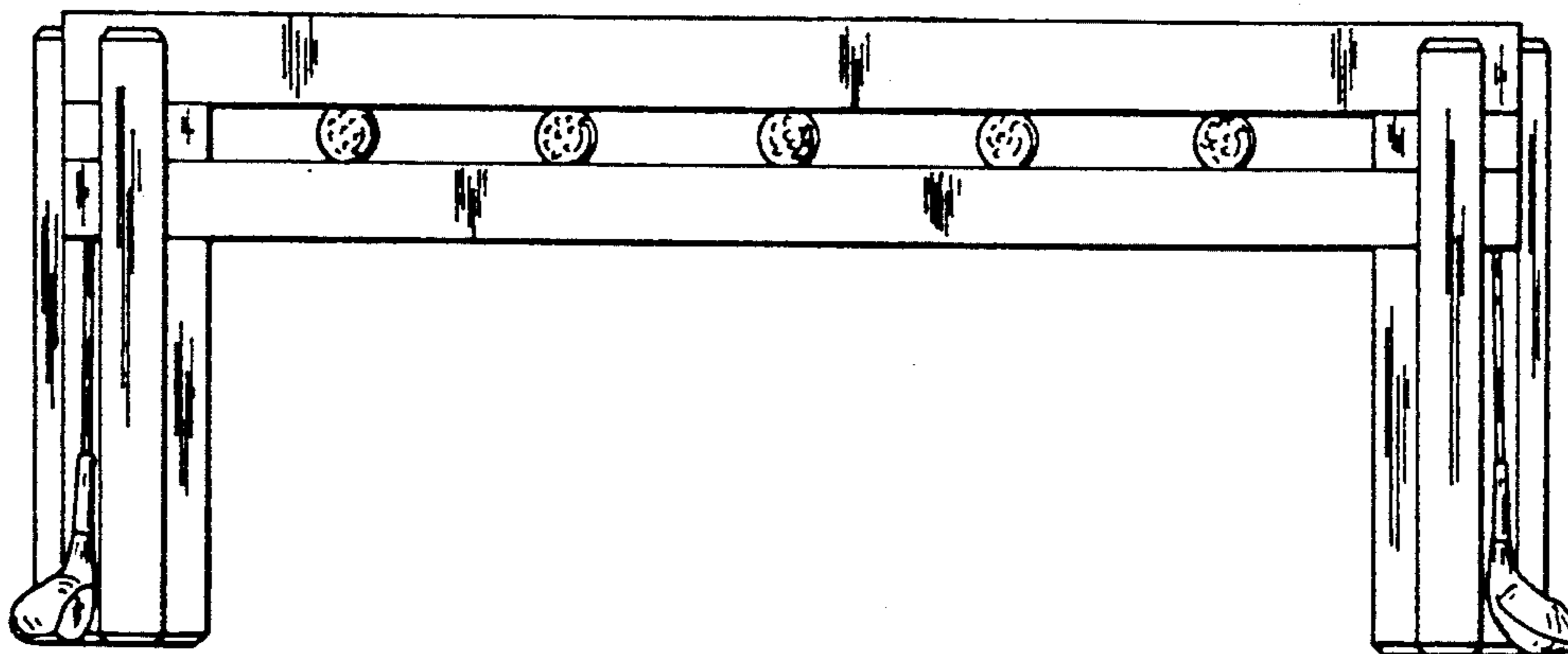

FIG. 2

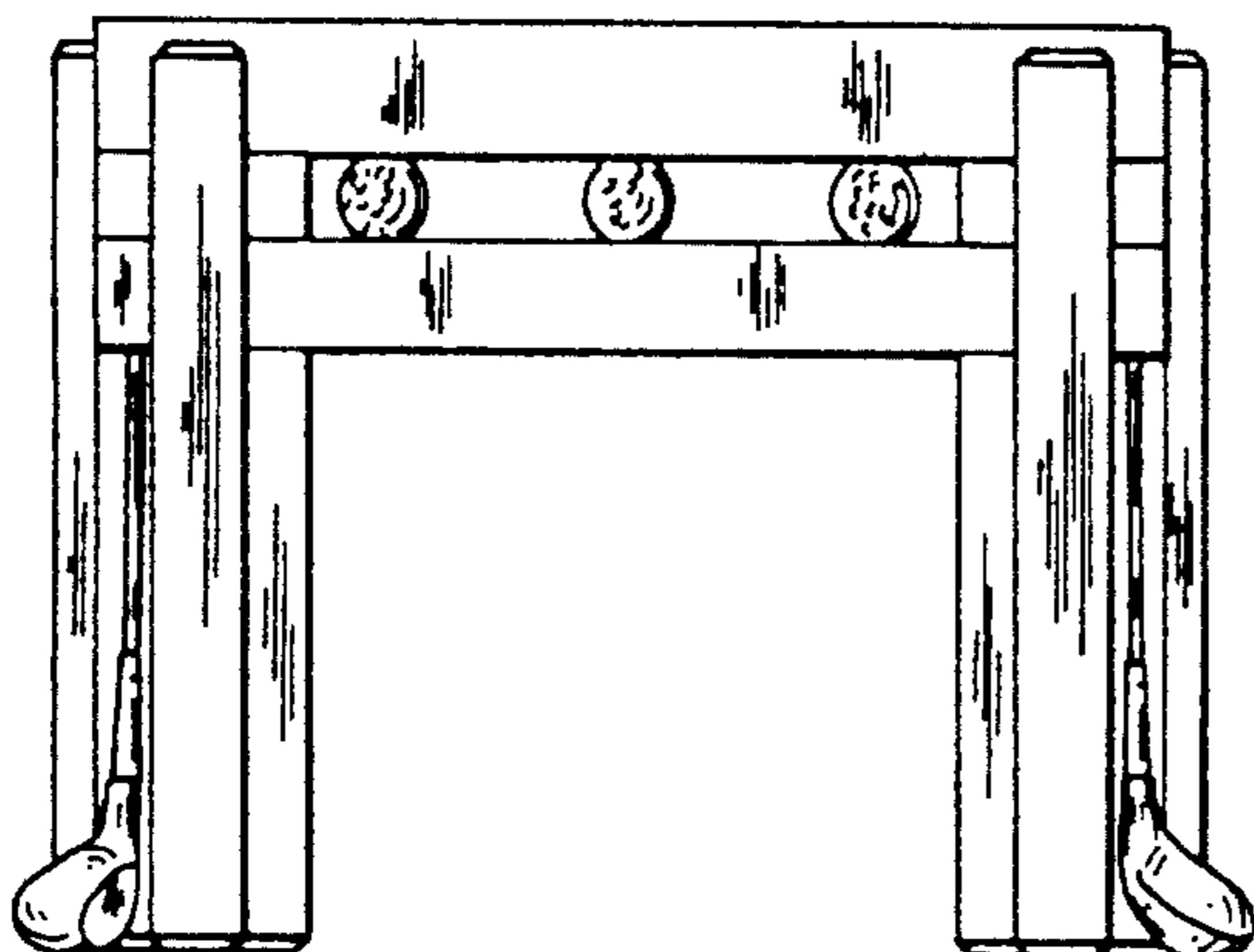

FIG. 3

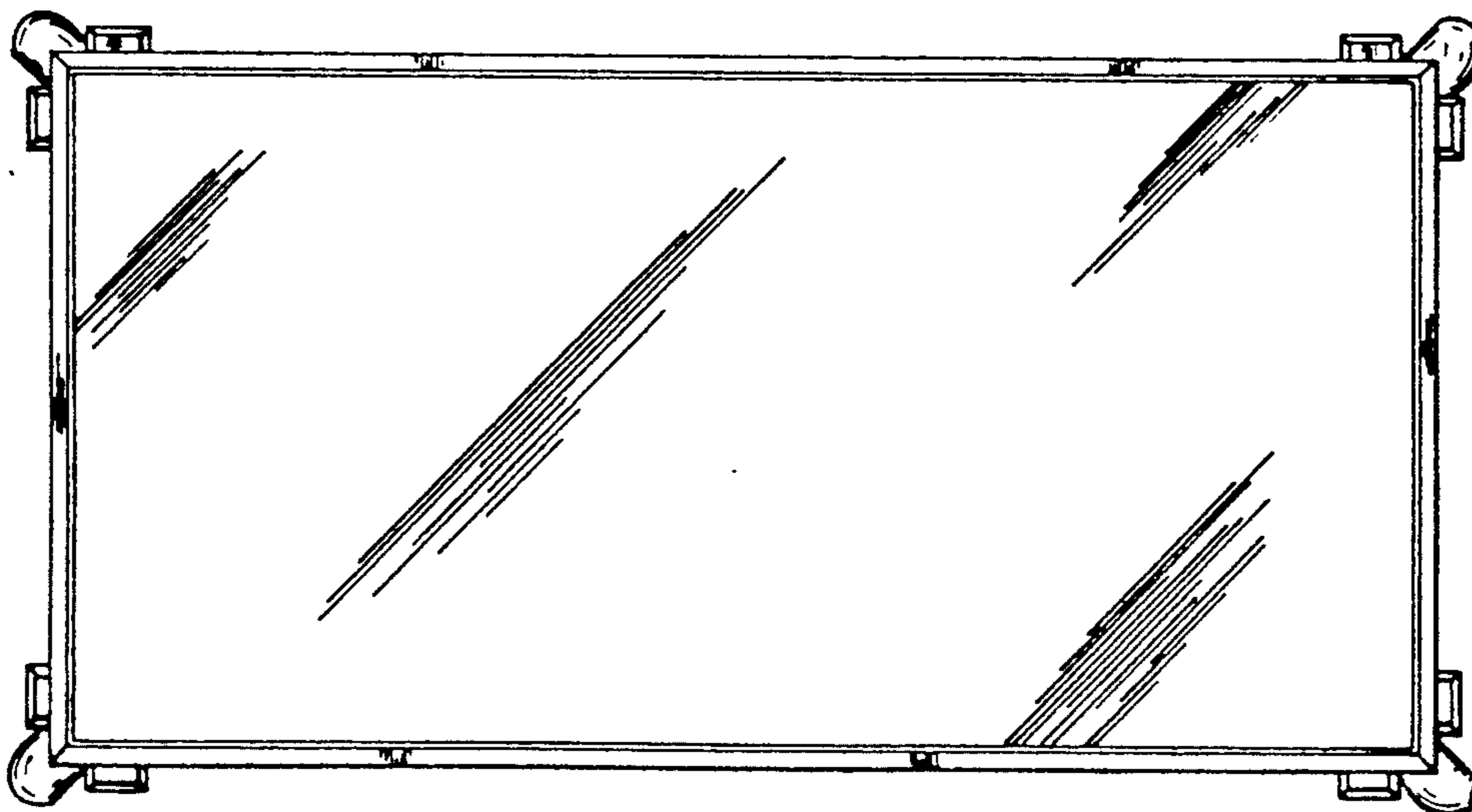

FIG. 4

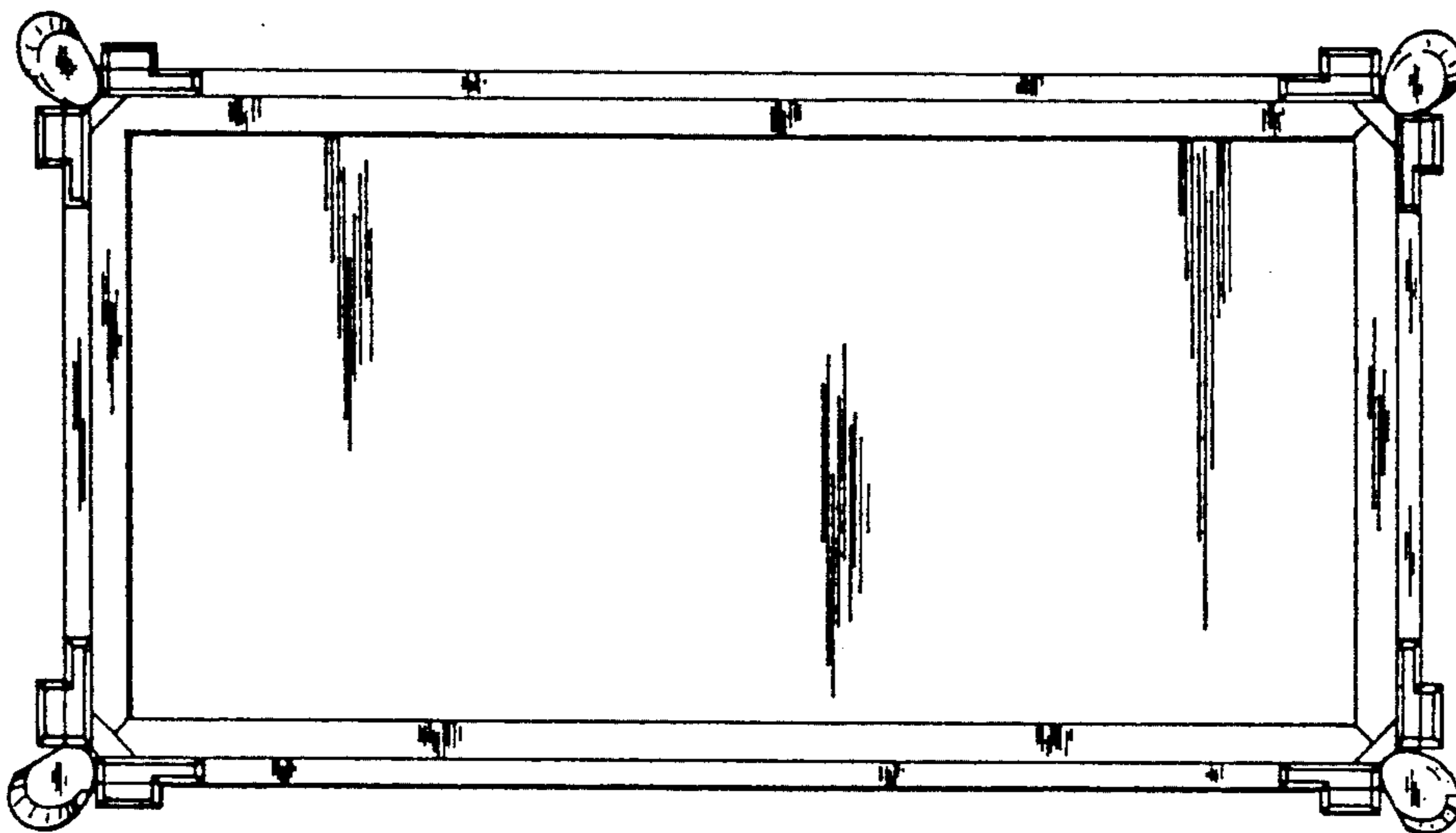

FIG. 5

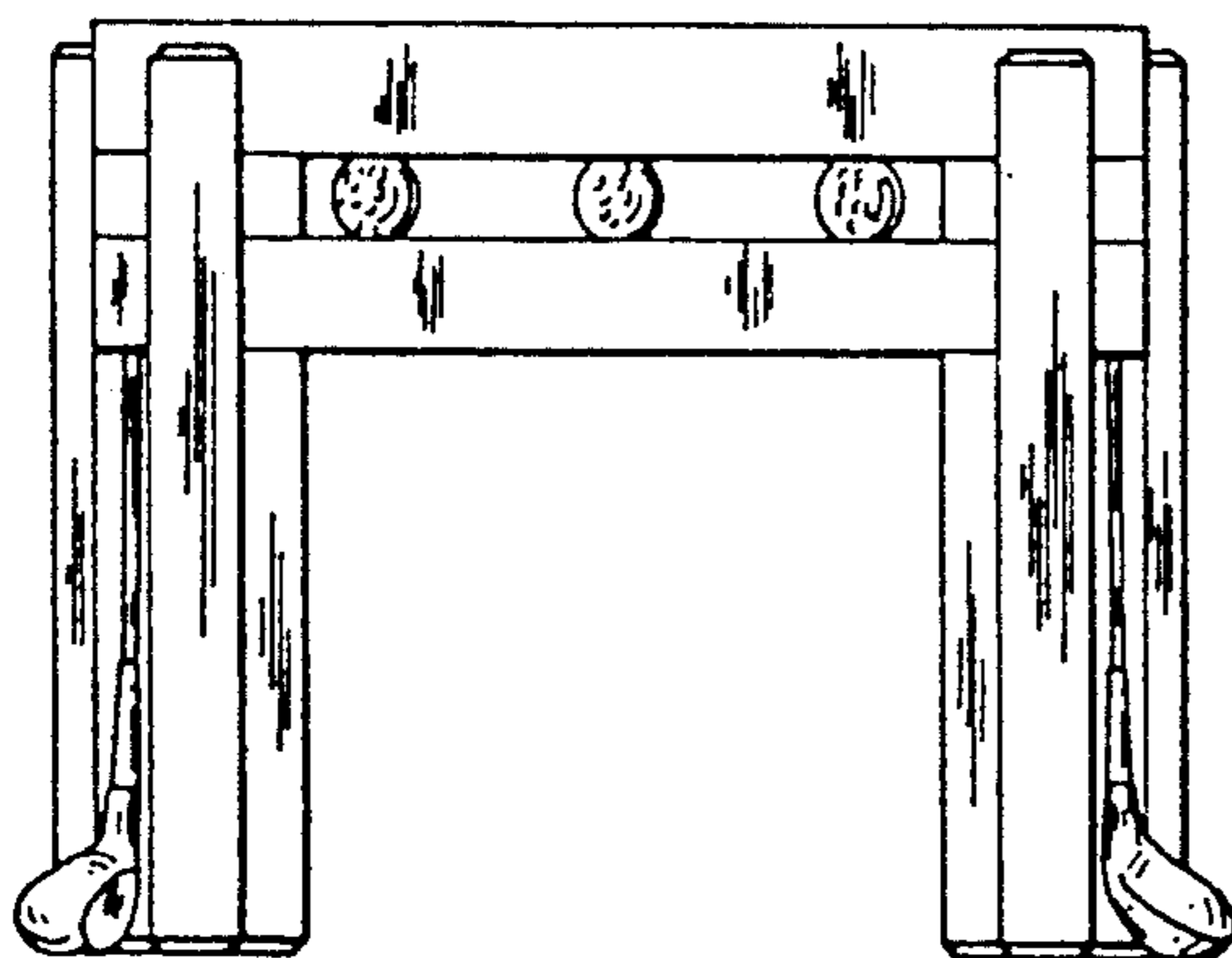

FIG. 6

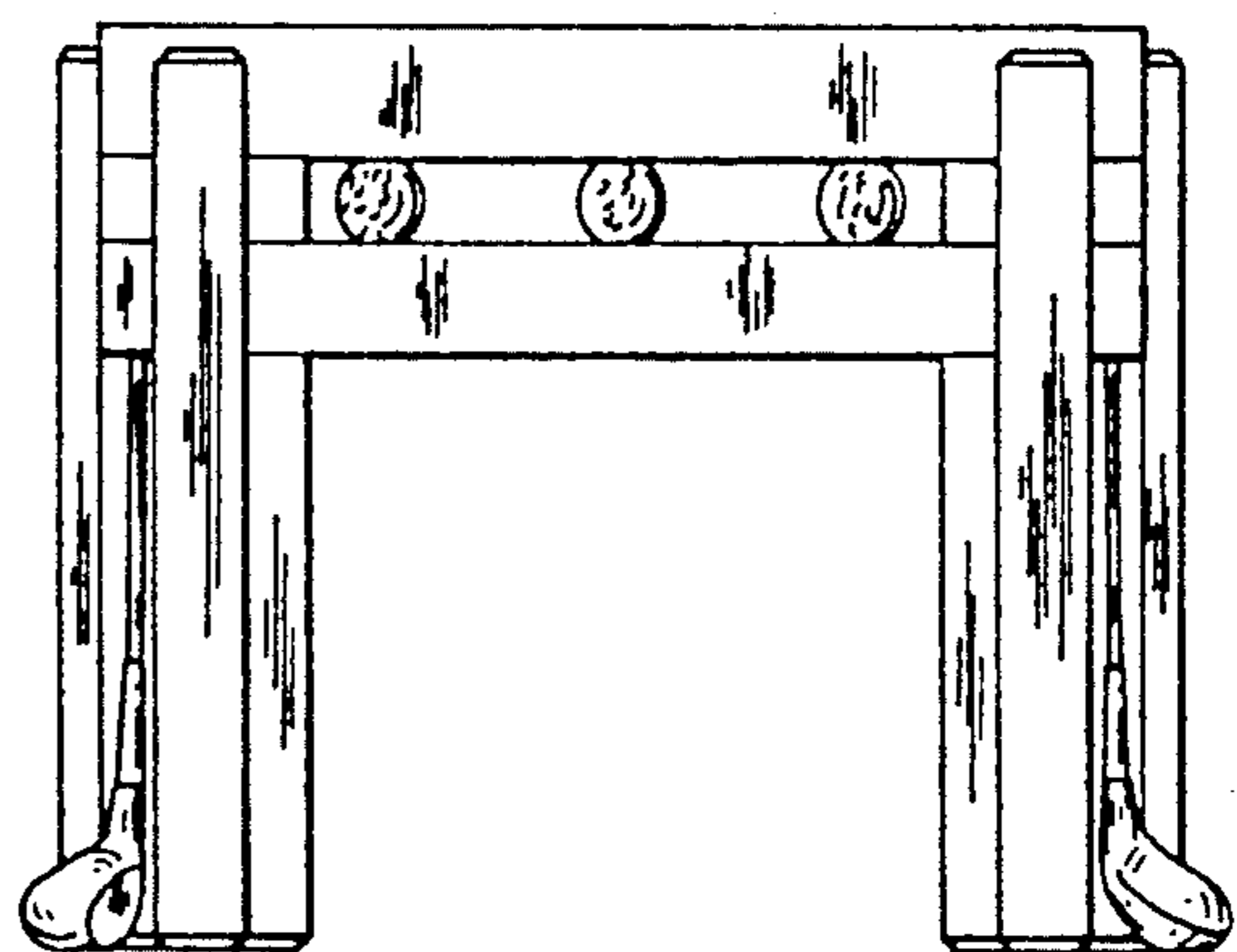

FIG. 7

