



US00D346913S

United States Patent [19]

[11] Patent Number: **Des. 346,913**

Lechman et al.

[45] Date of Patent: **** May 17, 1994**

[54] **DESK**

[57] **CLAIM**

[75] Inventors: **John N. Lechman; Thomas Wegman,**
both of Effingham, Ill.

The ornamental design for a desk, as shown and described.

[73] Assignee: **Nova Office Furniture, Inc.,**
Effingham, Ill.

DESCRIPTION

[**] Term: **14 Years**

FIG. 1 is a rear perspective view of a desk showing our new design;

[21] Appl. No.: **714,179**

FIG. 2 is a right rear elevational view thereof;

[22] Filed: **Jun. 11, 1991**

FIG. 3 is a top plan view thereof;

[52] U.S. Cl. **D6/427**

FIG. 4 is a left rear elevational view thereof;

[58] Field of Search **D6/421-428,**
D6/480, 484; 312/194-196; 108/59, 60, 92

FIG. 5 is a right front elevational view thereof;

FIG. 6 is a left front elevational view thereof;

FIG. 7 is a rear perspective view of a second embodiment of the desk shown in FIG. 1.

[56] **References Cited**

U.S. PATENT DOCUMENTS

D. 99,564	5/1936	Talbert	D6/428
D. 273,449	4/1984	Wieczorek	D6/426
D. 279,846	7/1985	Esslinger	D6/484 X
D. 329,551	9/1992	Lechman	D6/422
3,533,362	10/1970	Thompson	312/195 X
4,345,803	8/1982	Heck	312/194

FIG. 8 is a left rear elevational view thereof;

FIG. 9 is a top plan view thereof;

FIG. 10 is a right rear elevational view thereof;

FIG. 11 is a right front elevational view thereof;

FIG. 12 is a left front elevational view thereof;

FIG. 13 is a rear perspective view of a third embodiment of the desk shown in FIG. 1;

FIG. 14 is a right rear elevational view thereof;

FIG. 15 is a top plan view thereof;

FIG. 16 is a left rear elevational view thereof;

FIG. 17 is a left front elevational view thereof;

FIG. 18 is a right front elevational view thereof;

FIG. 19 is a perspective view of fourth embodiment of the desk shown in FIG. 1;

FIG. 20 is left rear elevational view thereof;

FIG. 21 is a top plan view thereof;

FIG. 22 is a right rear elevational view thereof;

FIG. 23 is a right front elevational view thereof; and,

FIG. 24 is a left front elevational view thereof.

OTHER PUBLICATIONS

OPD, May 1984, p. 80; top corner desk on page.

Primary Examiner—Carmen H. Vales-Lado
Attorney, Agent, or Firm—Olson & Hierl, Ltd.

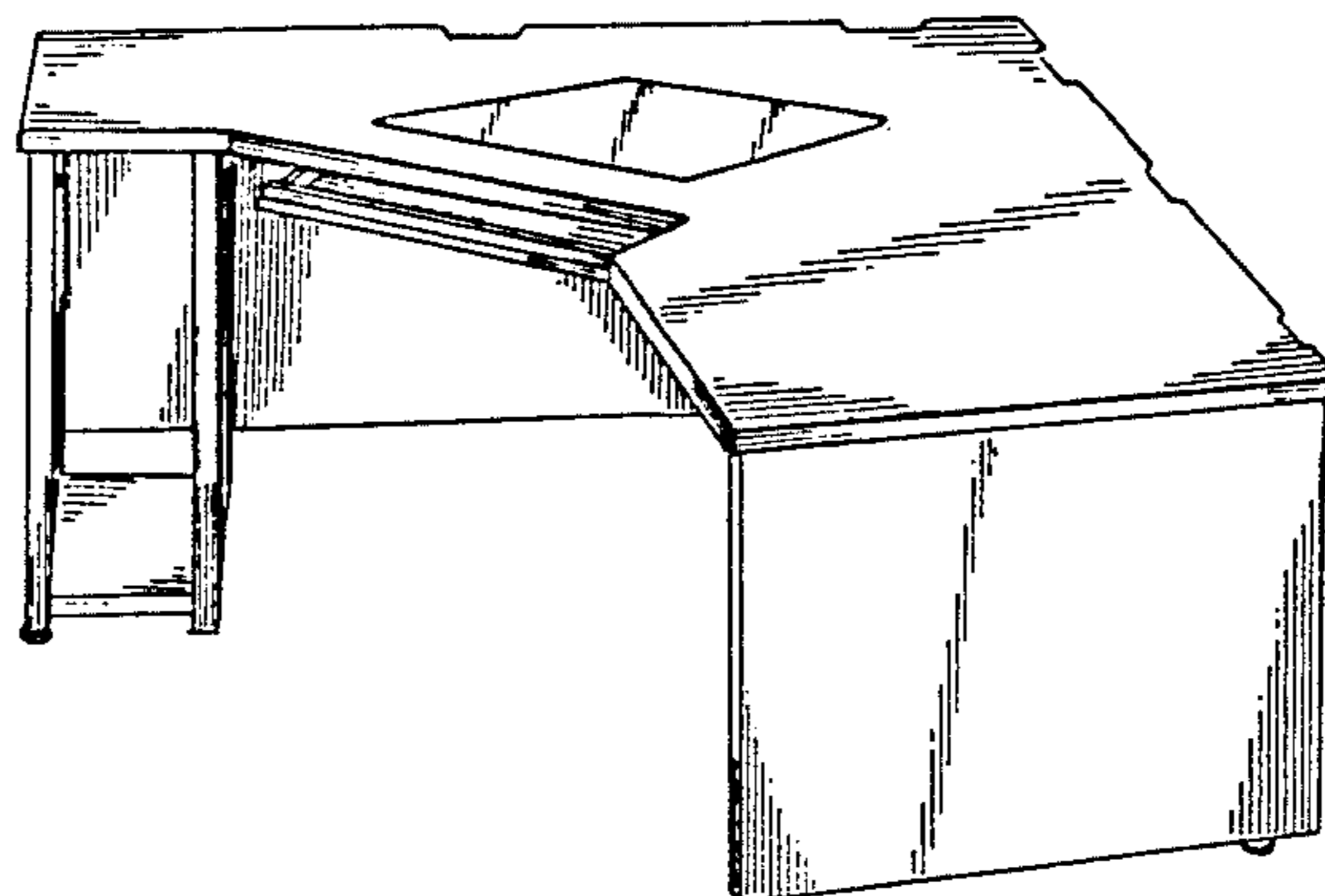
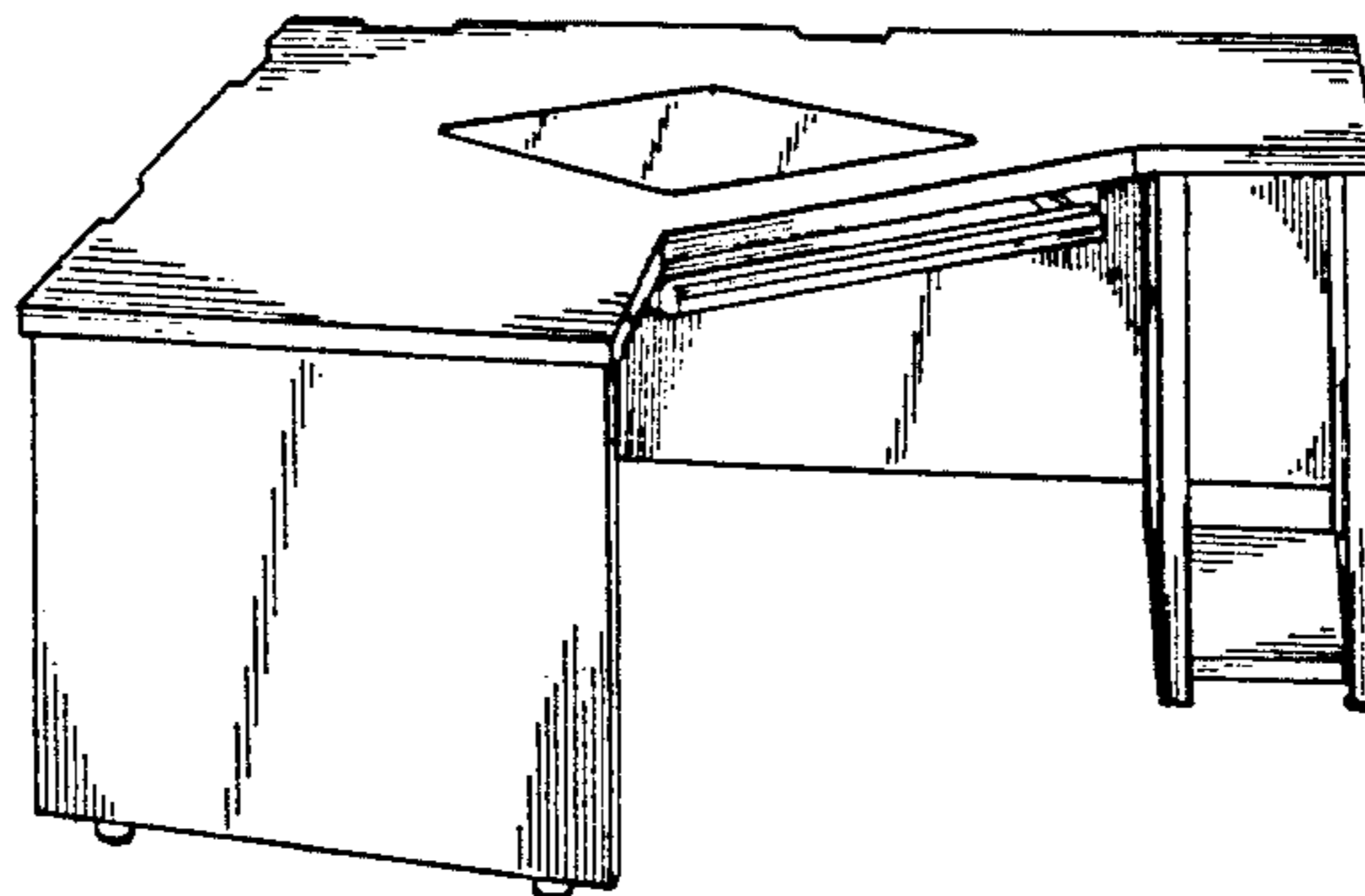

FIG. 1

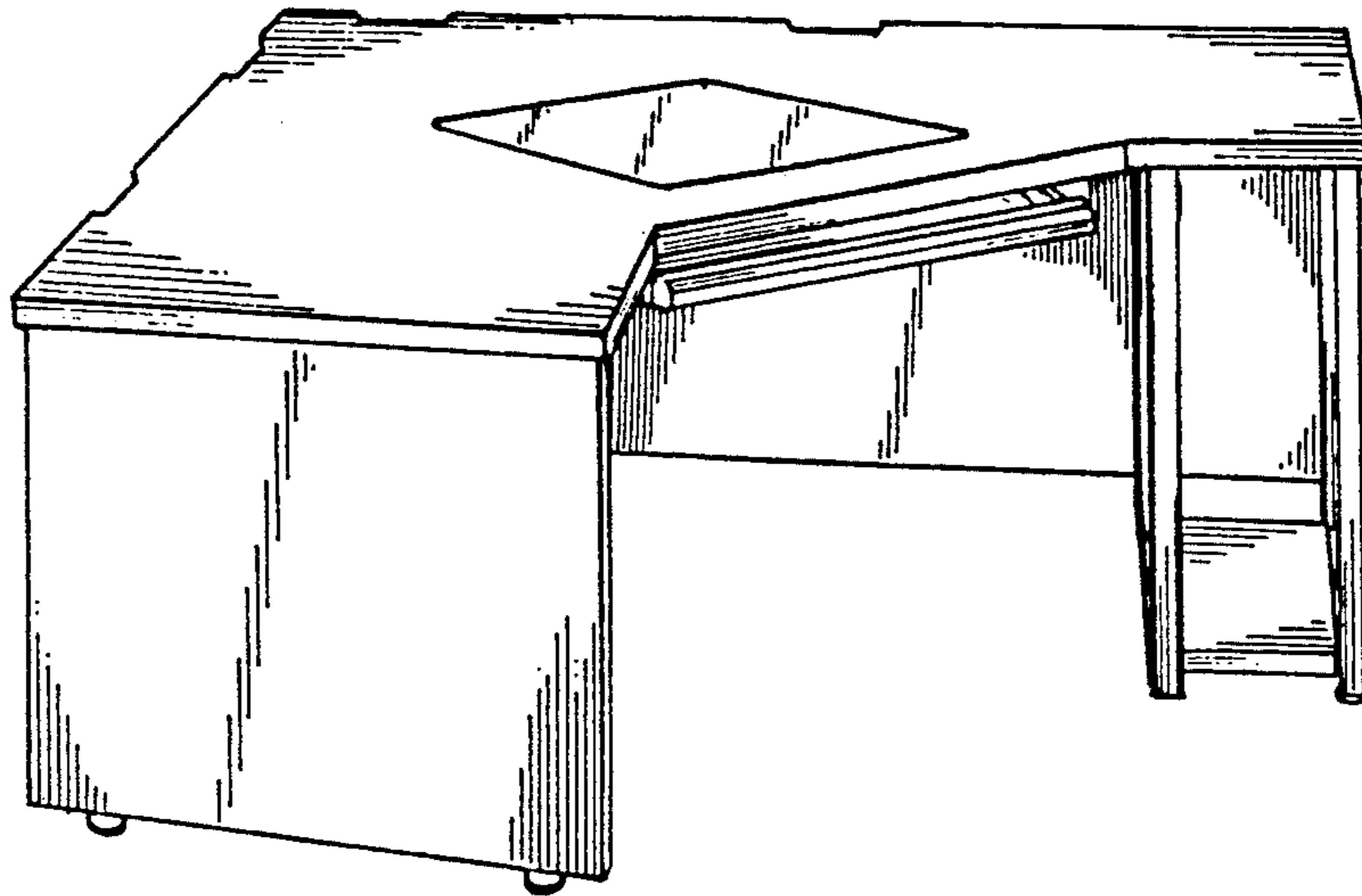

FIG. 2

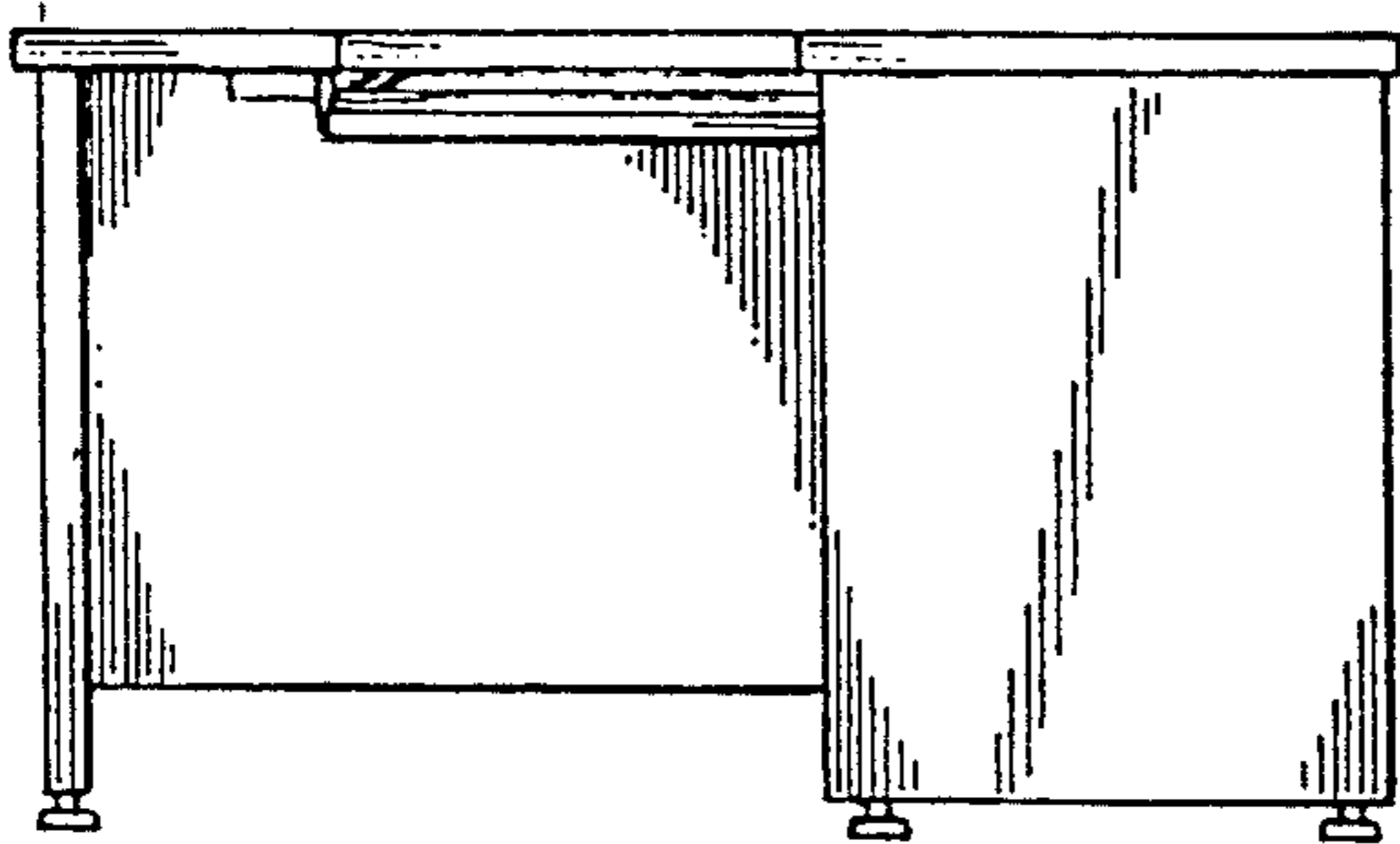

FIG. 3

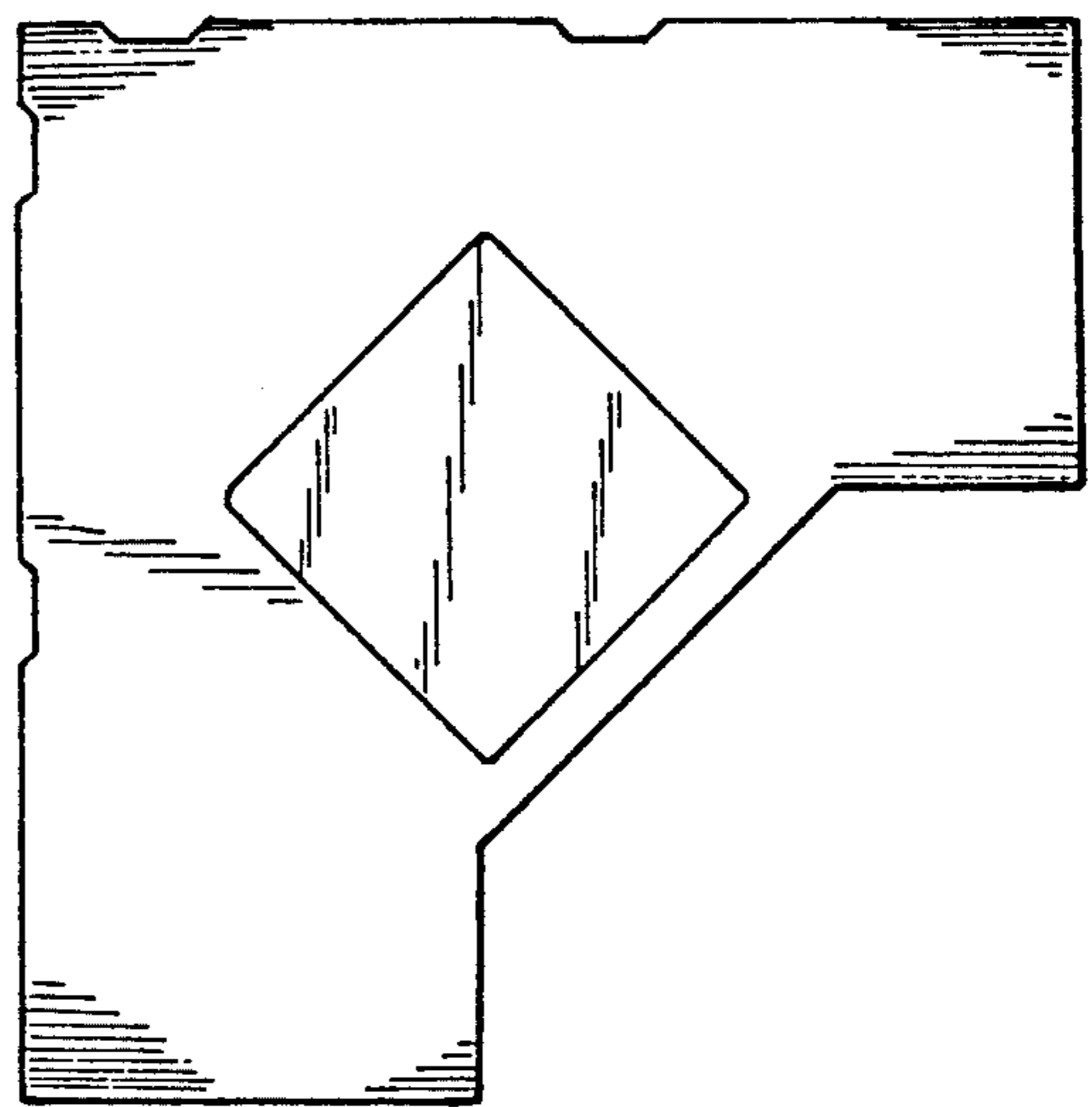

FIG. 4

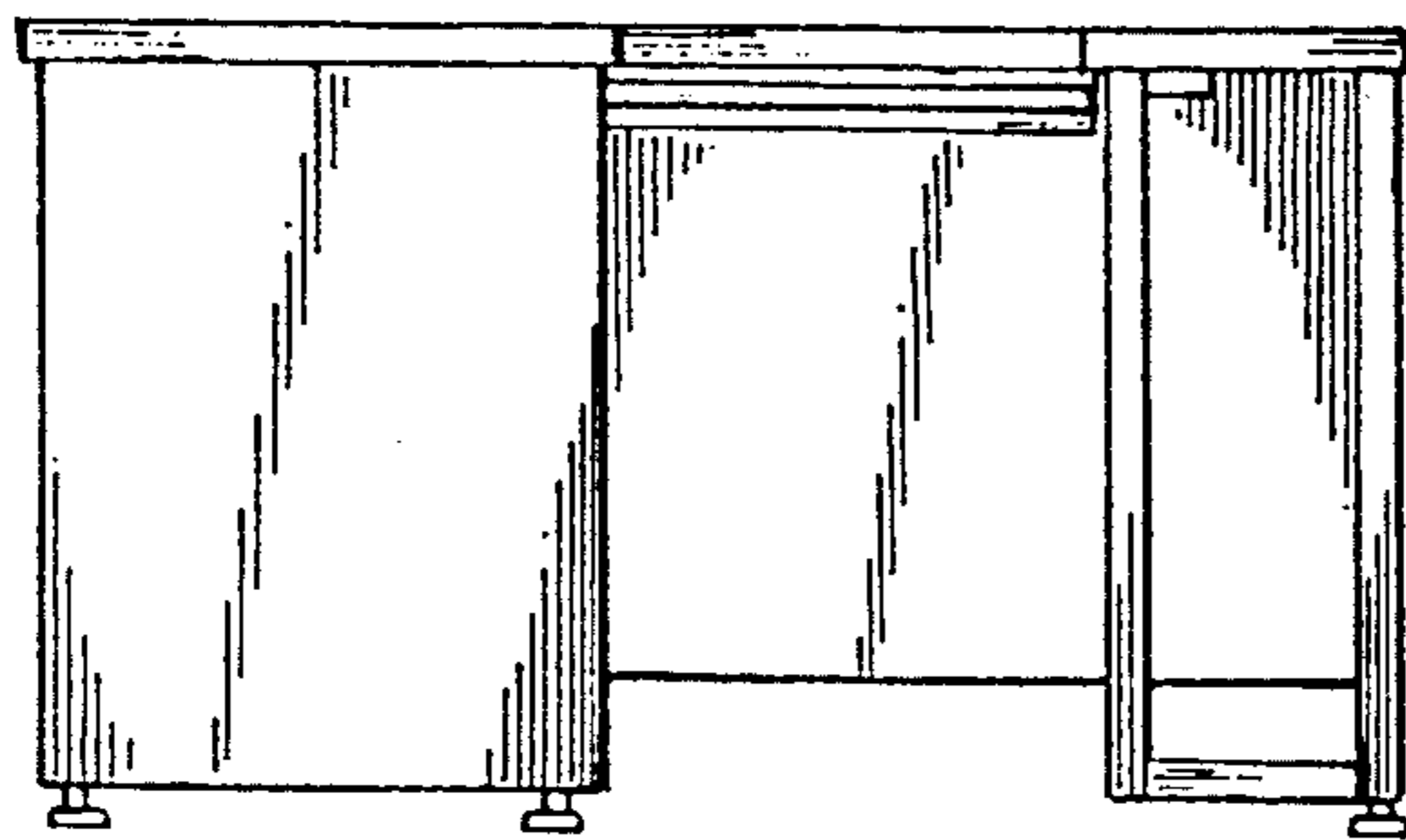

FIG. 5

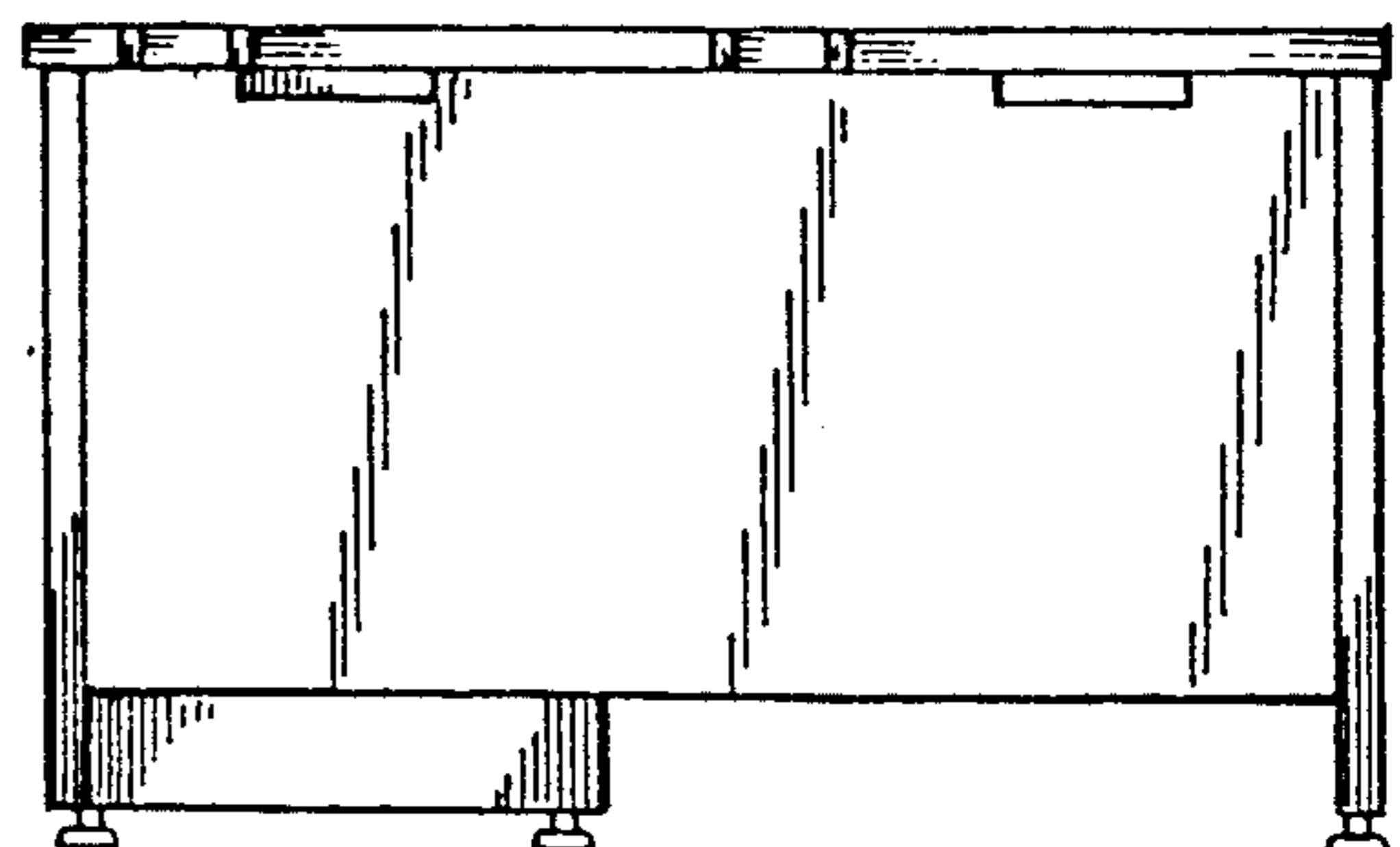

FIG. 6

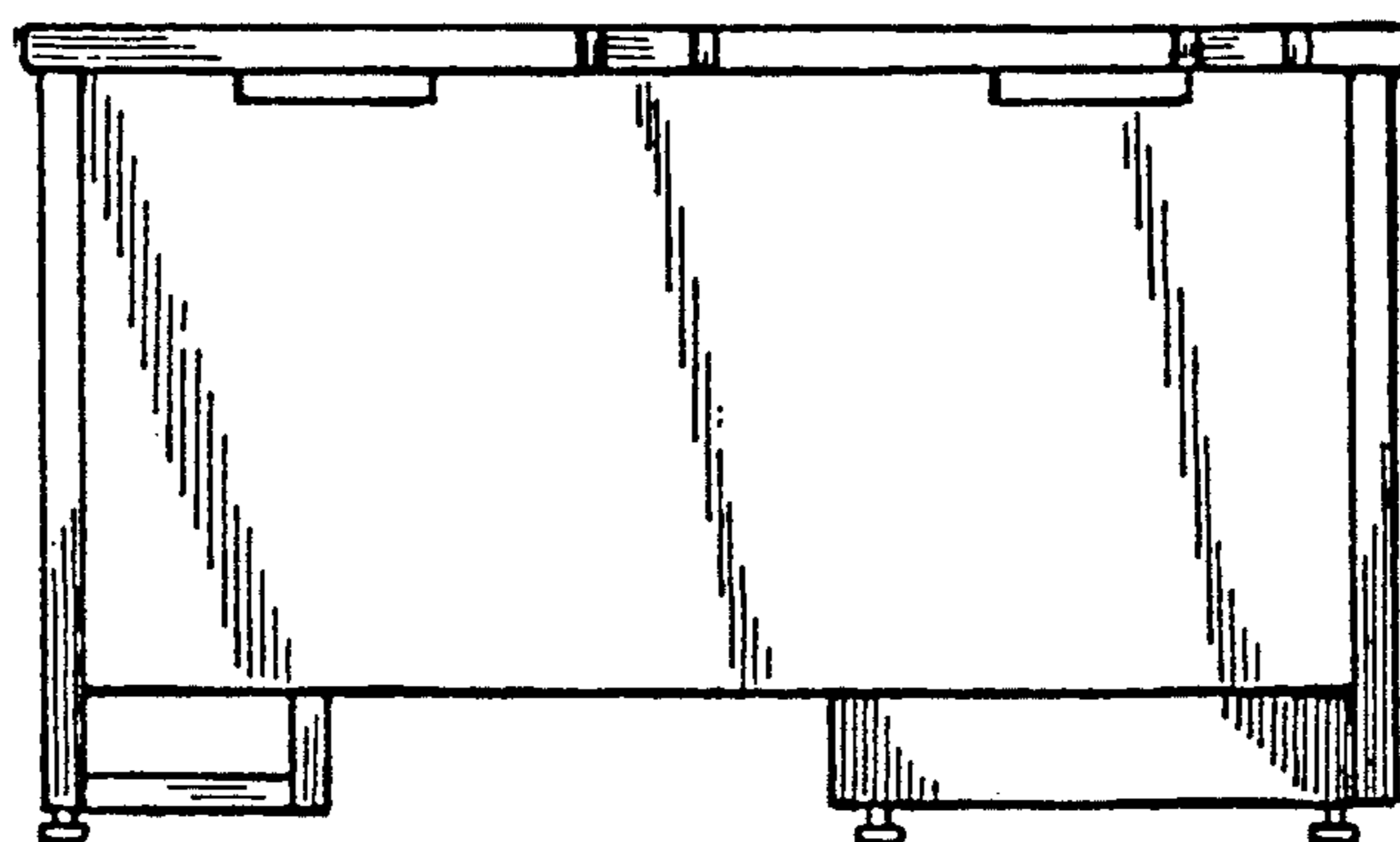

FIG. 7

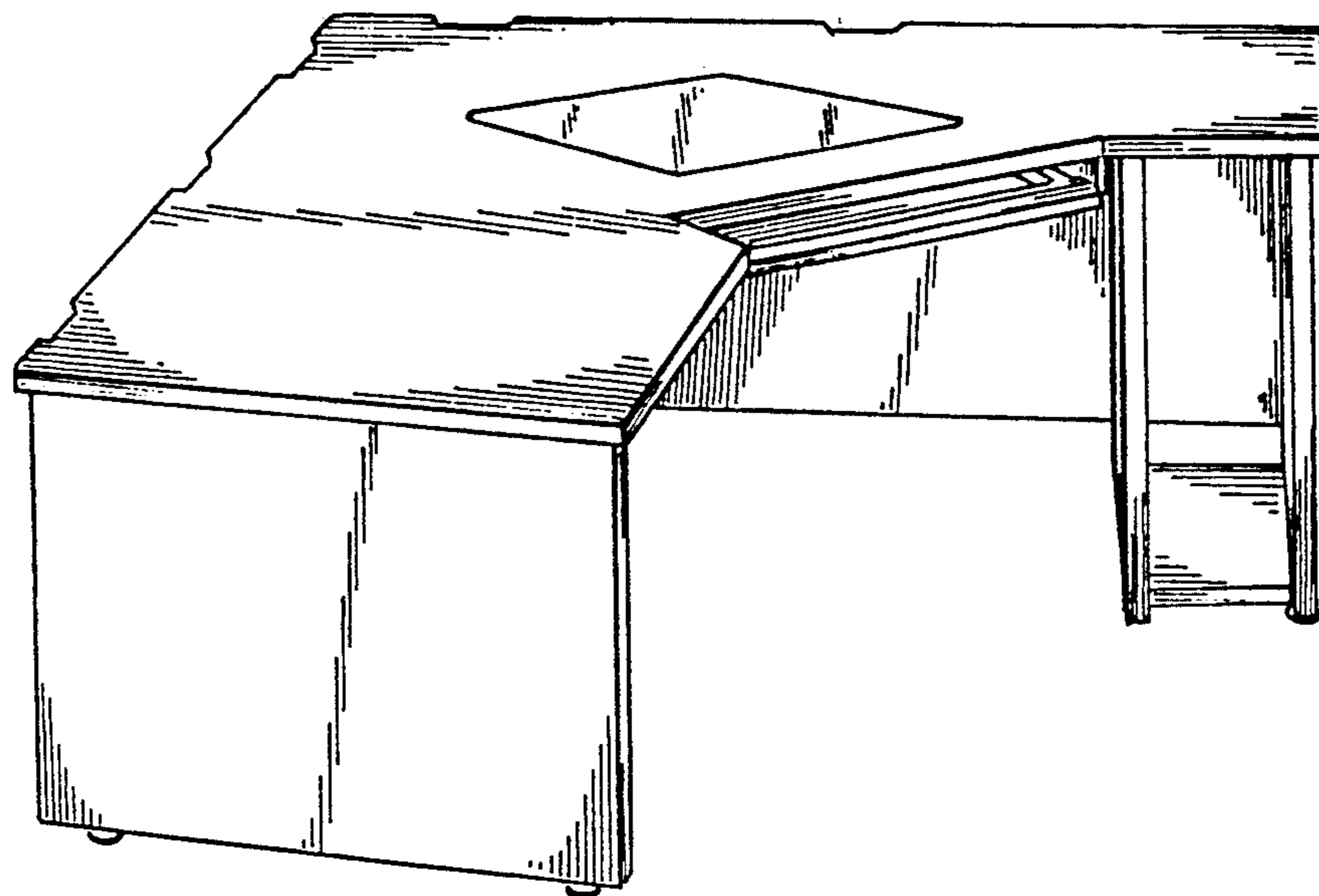

FIG. 9

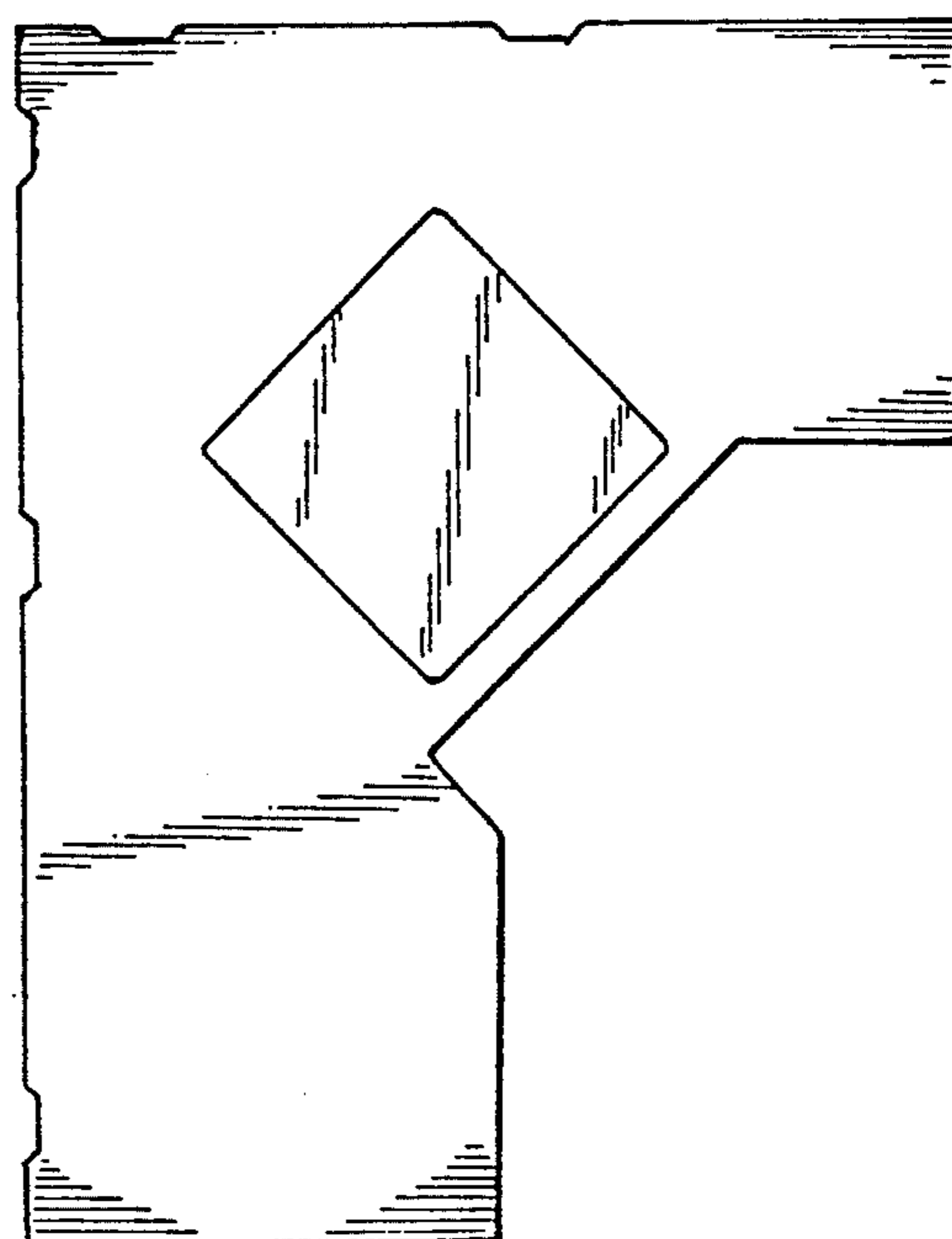

FIG. 8

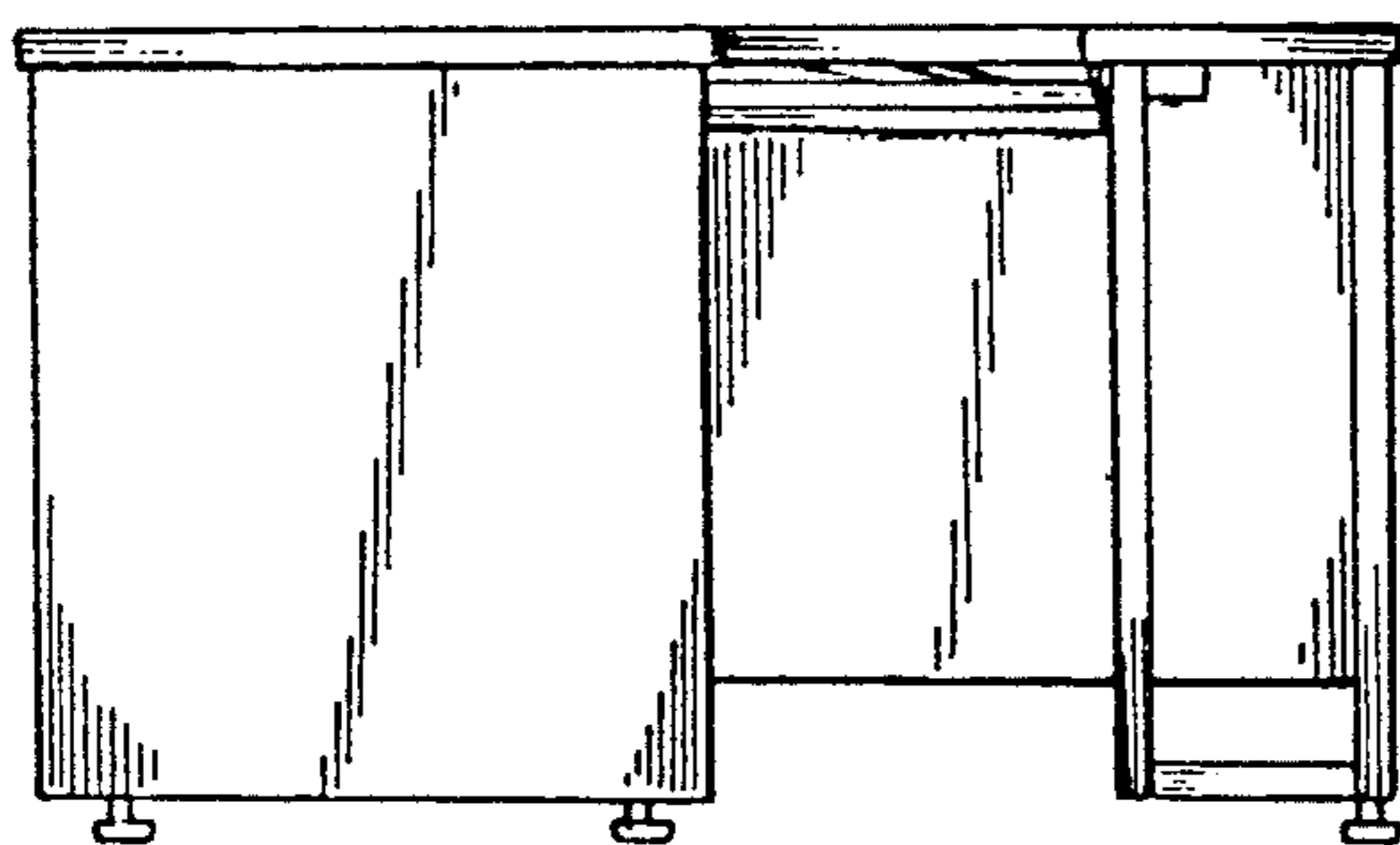

FIG. 10

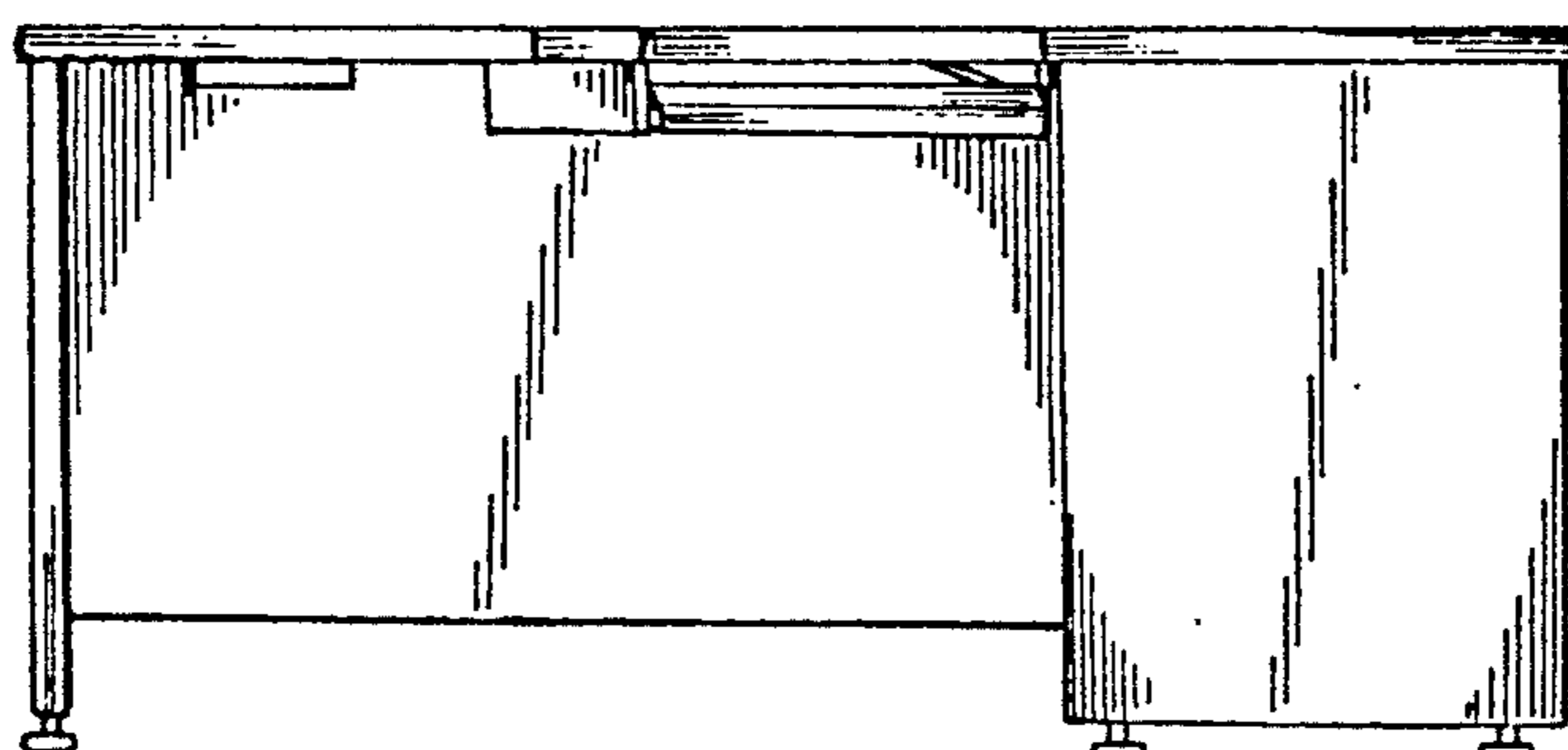

FIG. 11

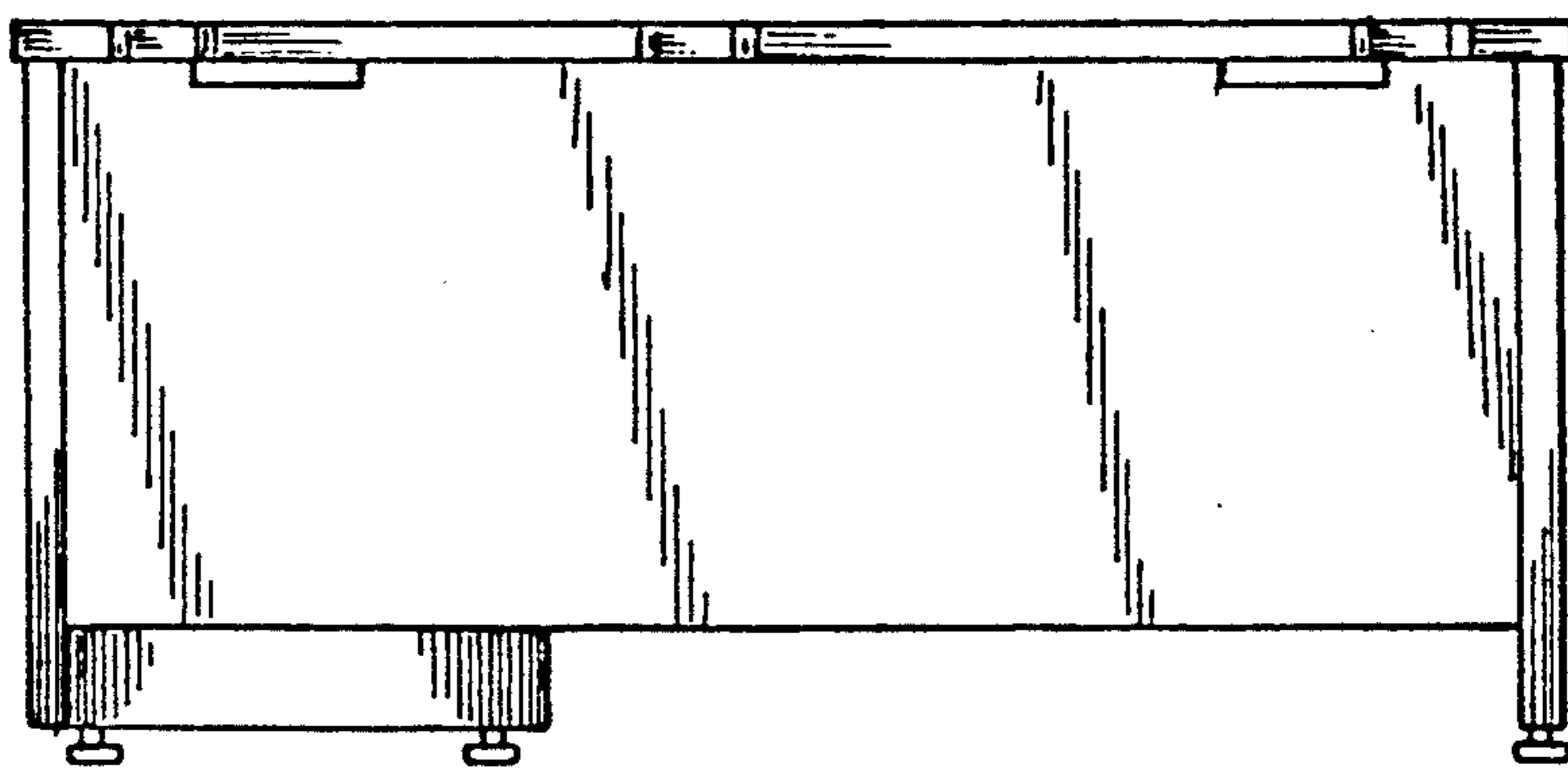

FIG. 12

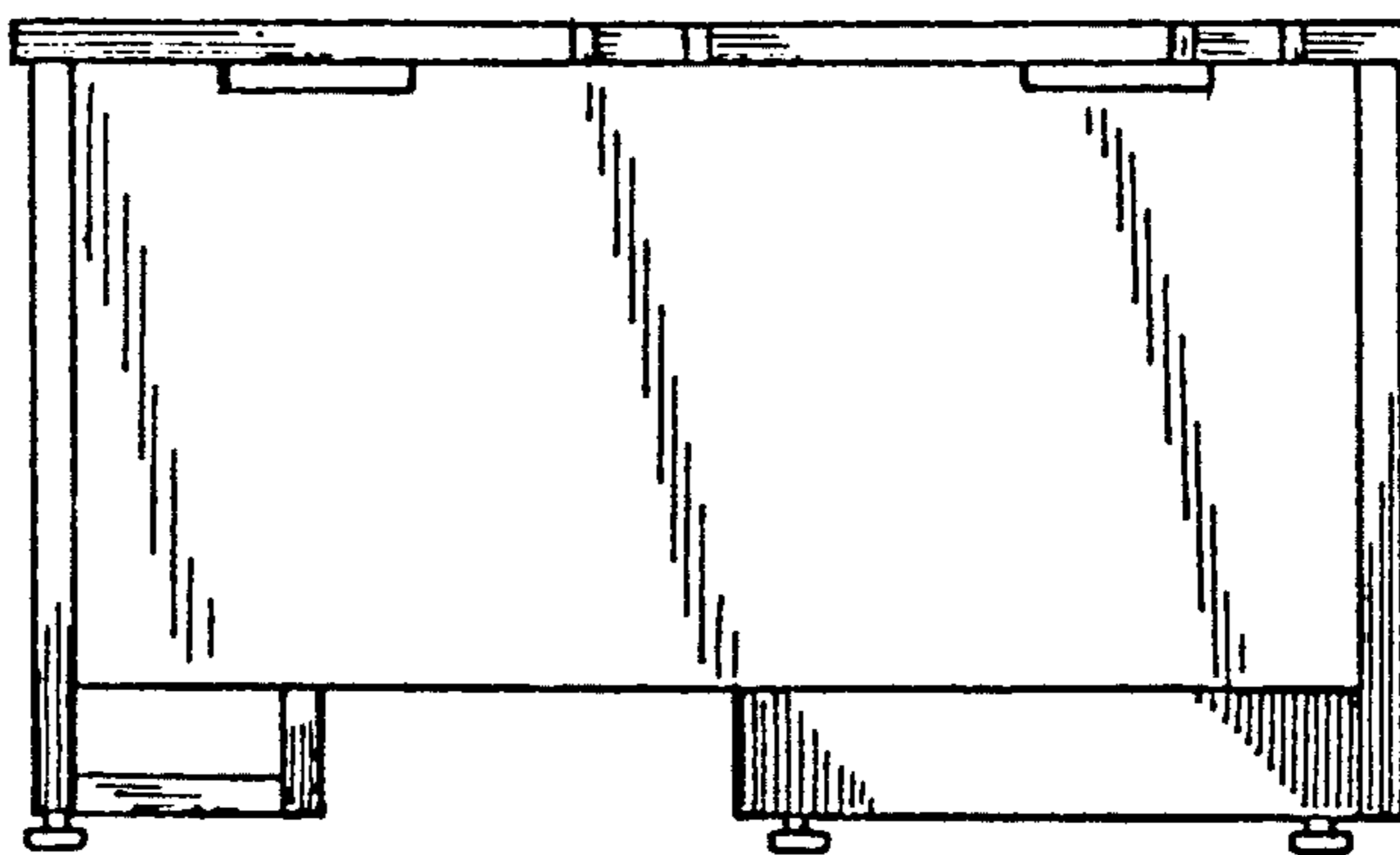

FIG. 13

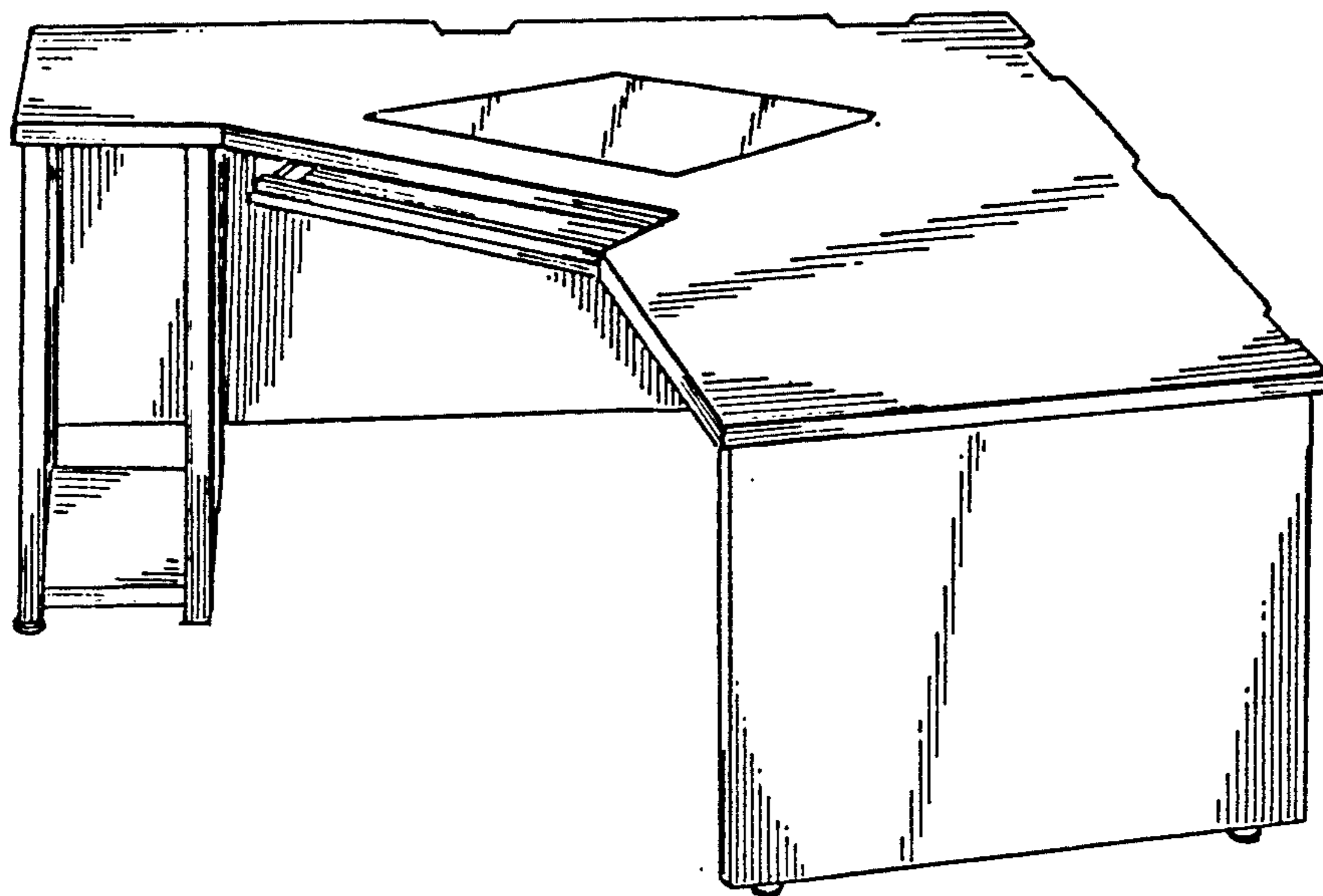

FIG. 15

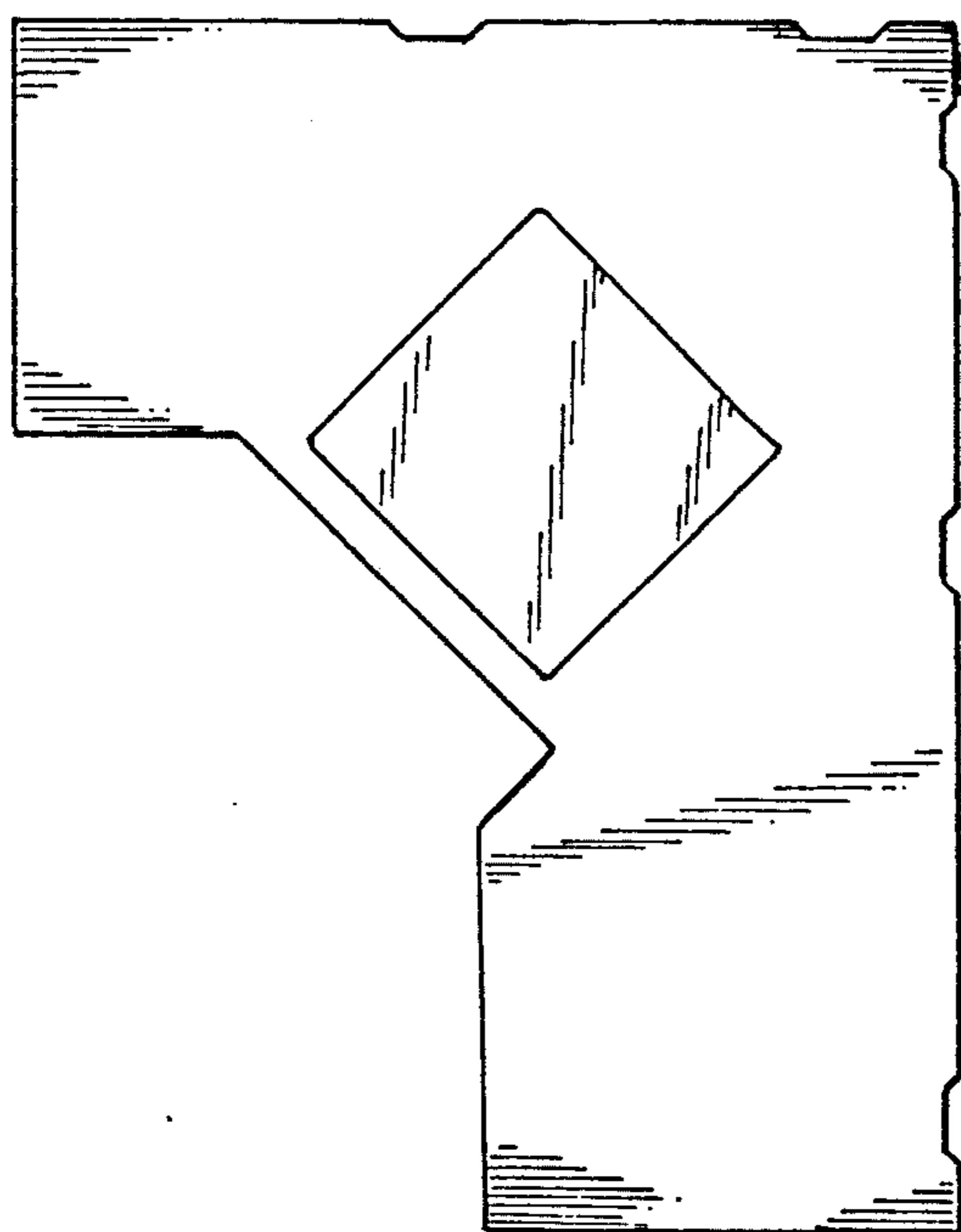

FIG. 14

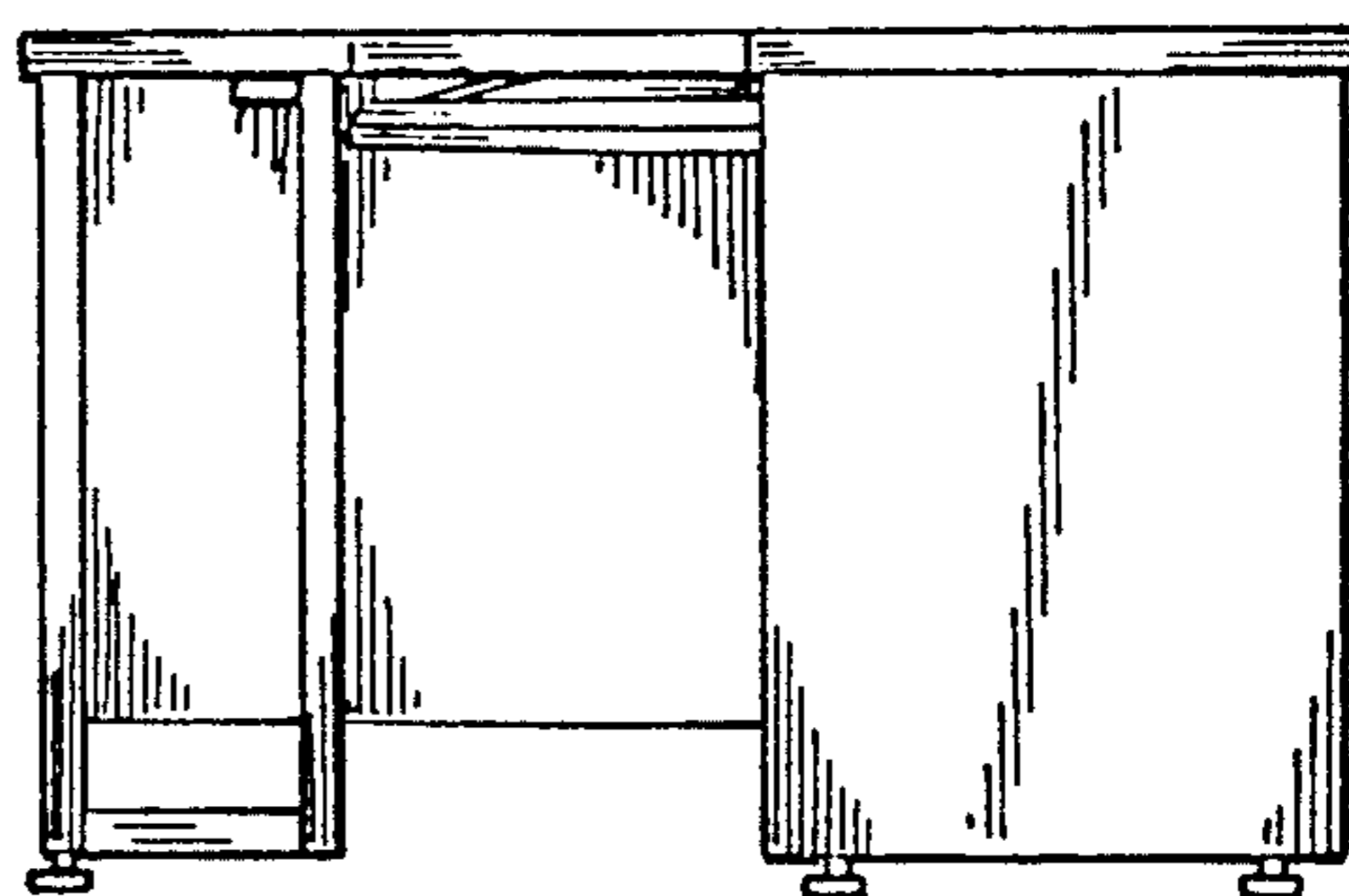

FIG. 16

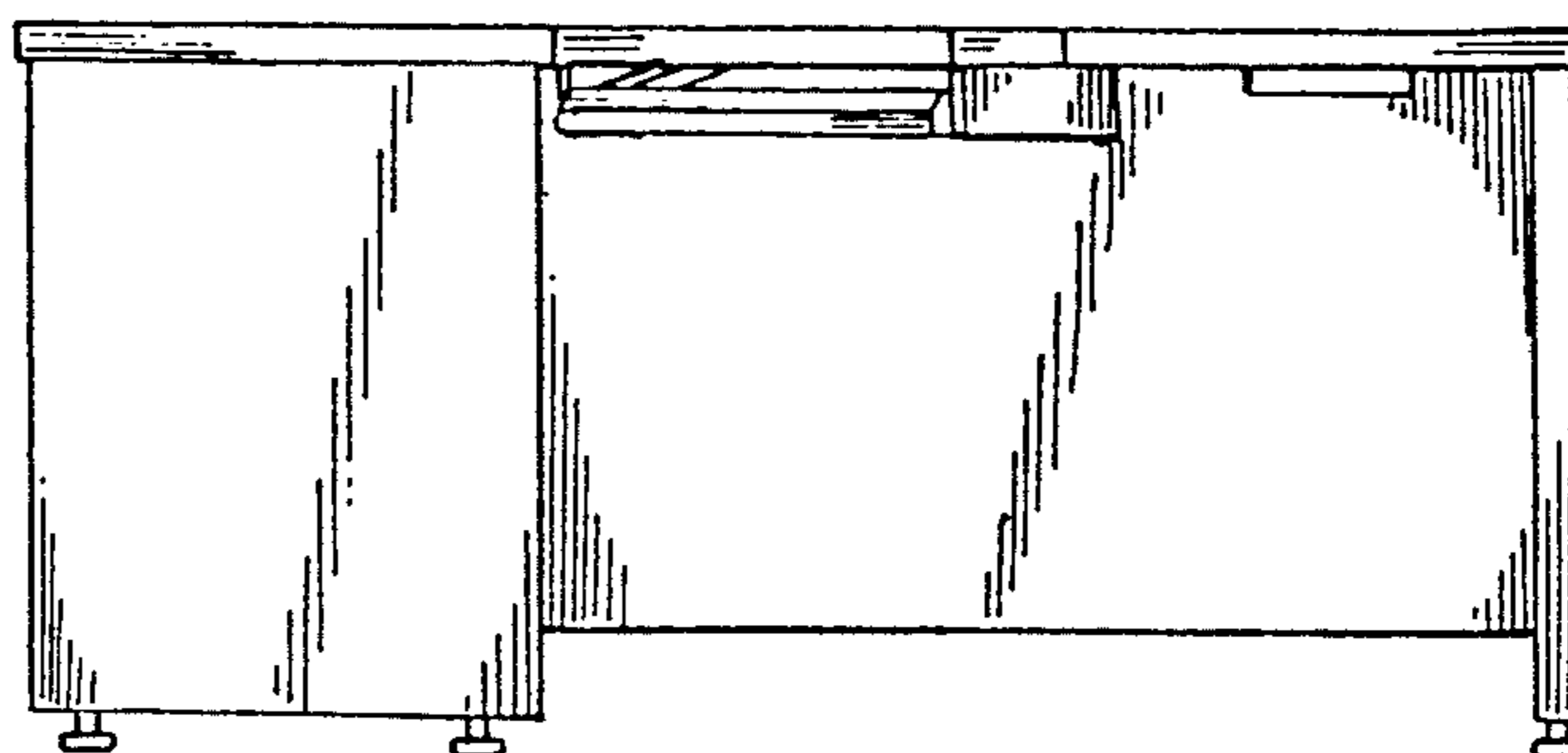

FIG. 17

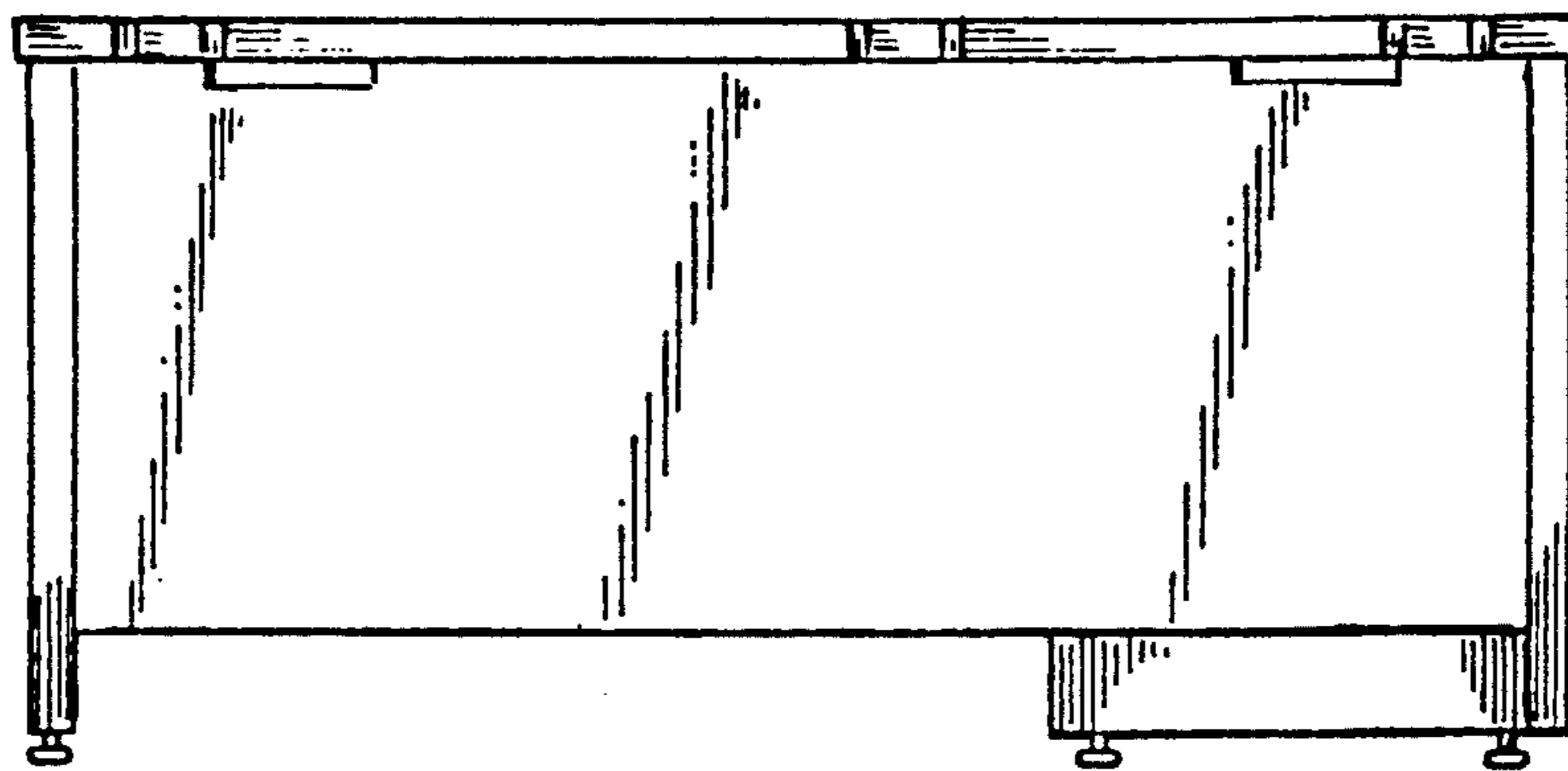
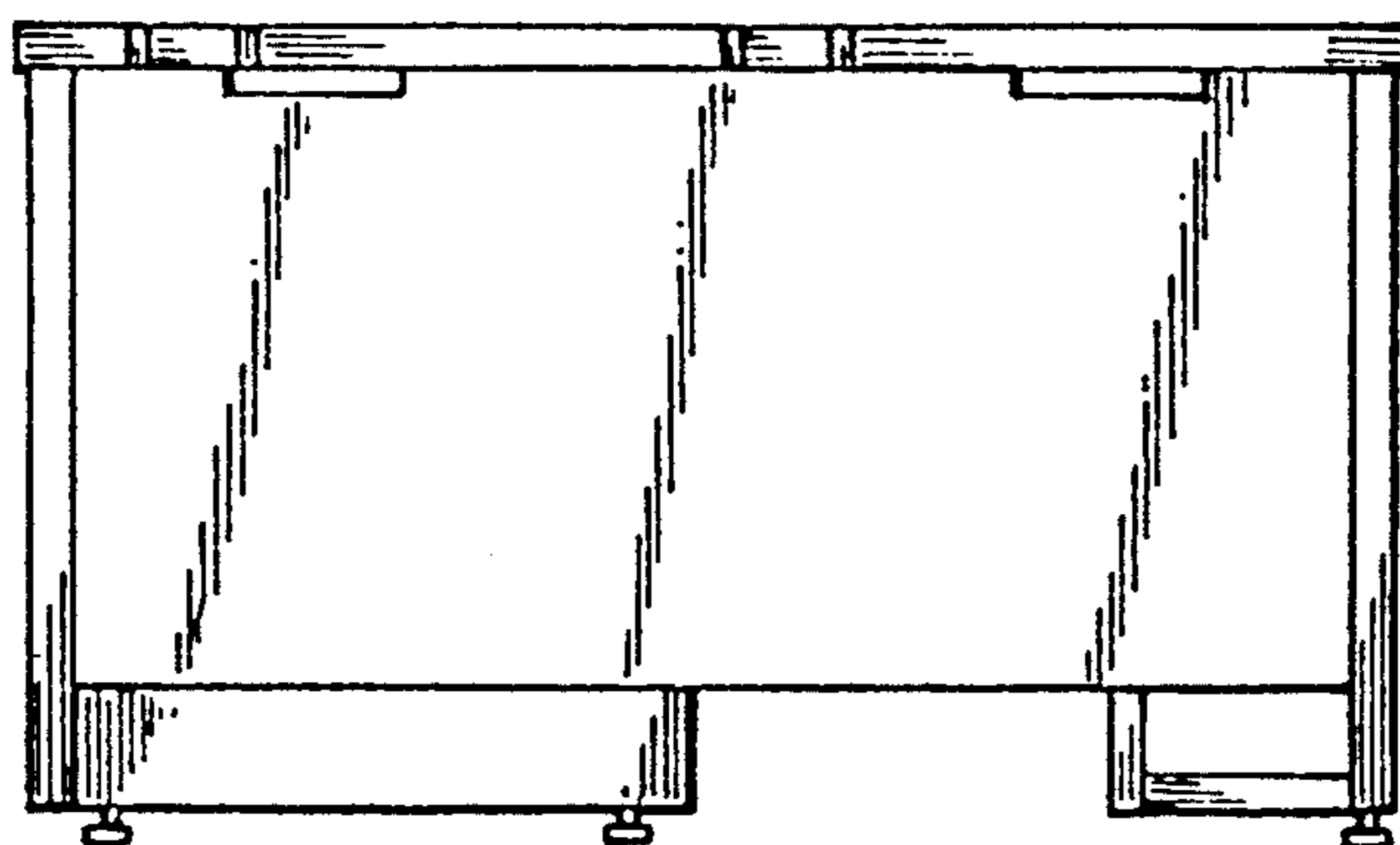

FIG. 18



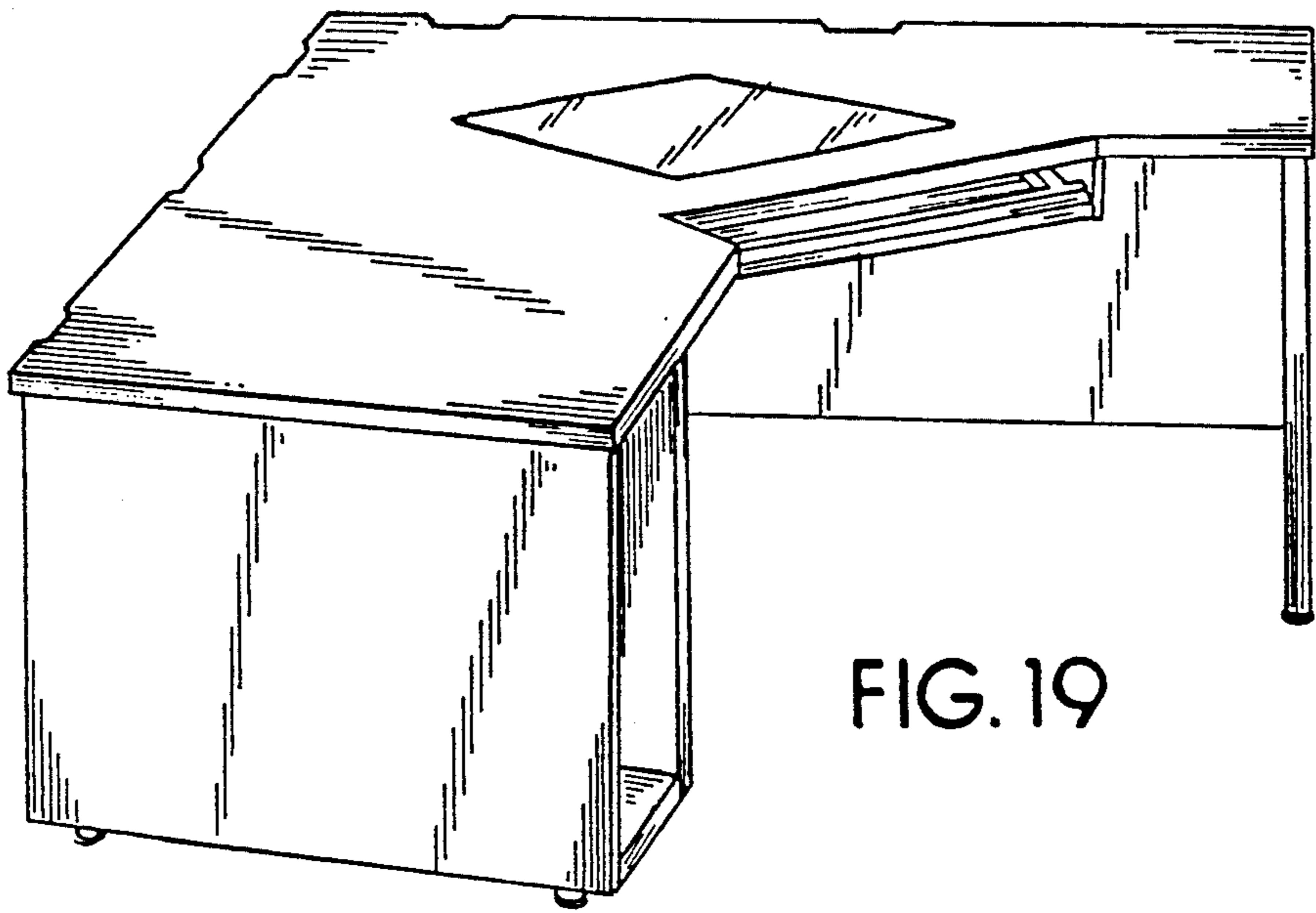

FIG. 19

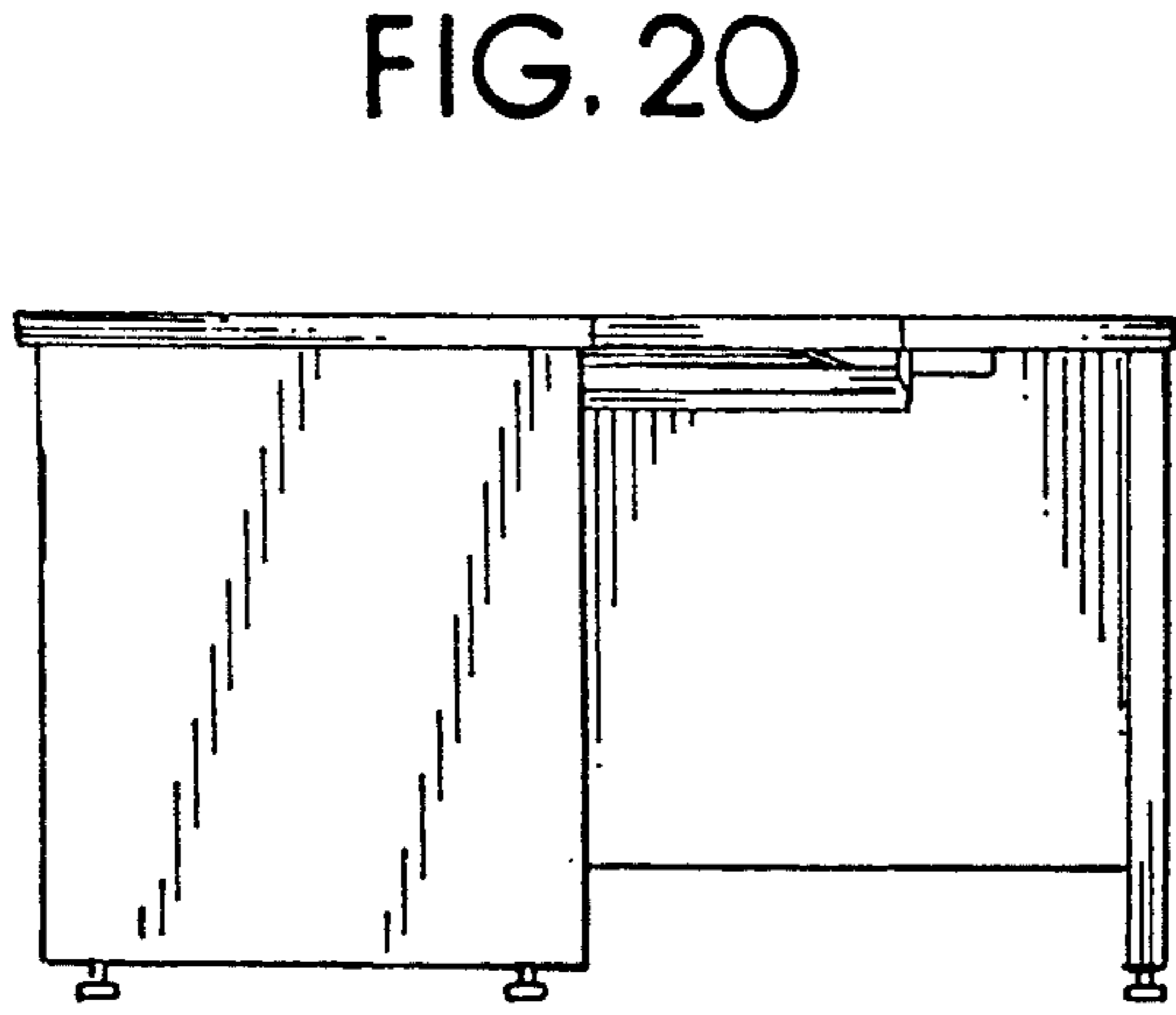

FIG. 20

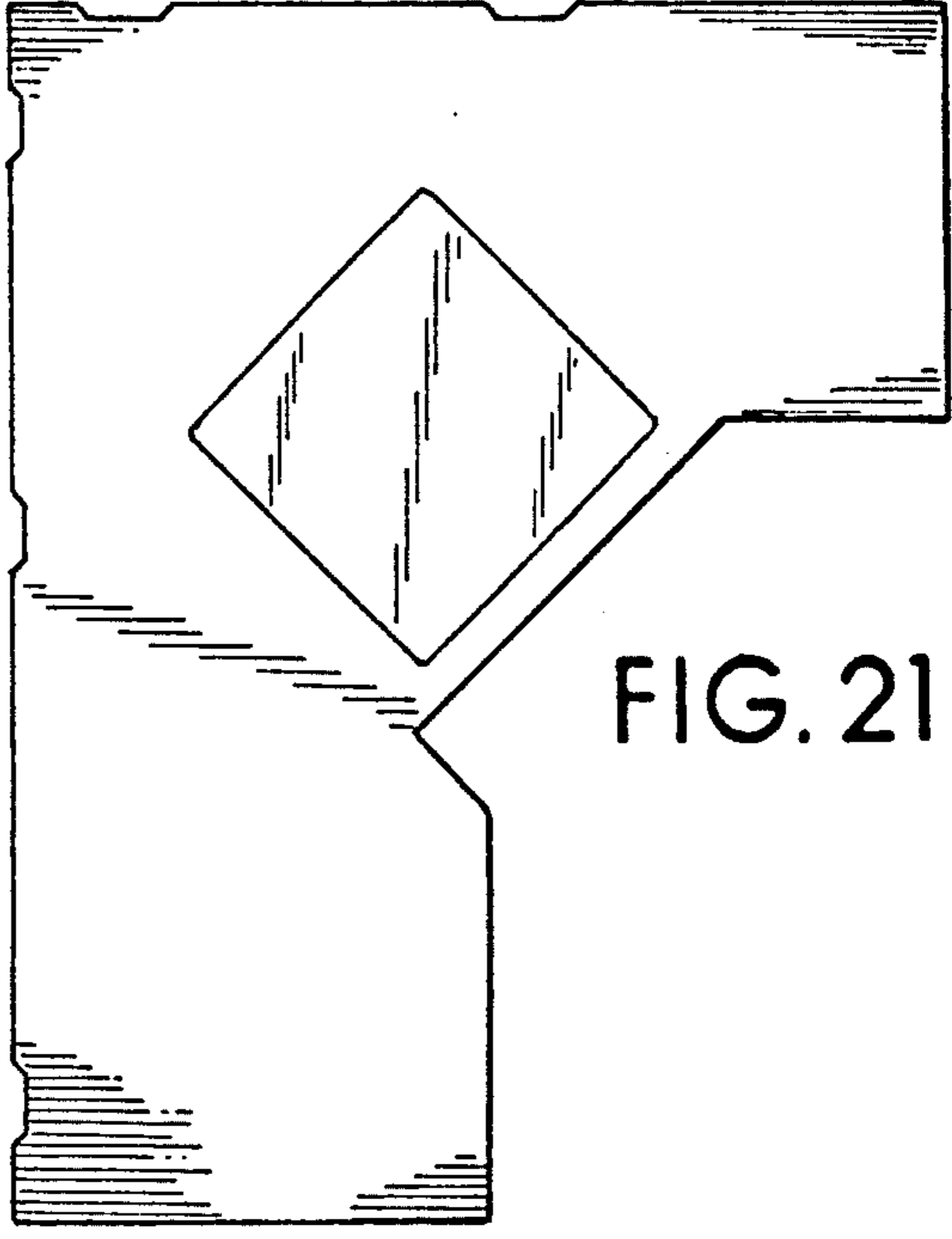

FIG. 21

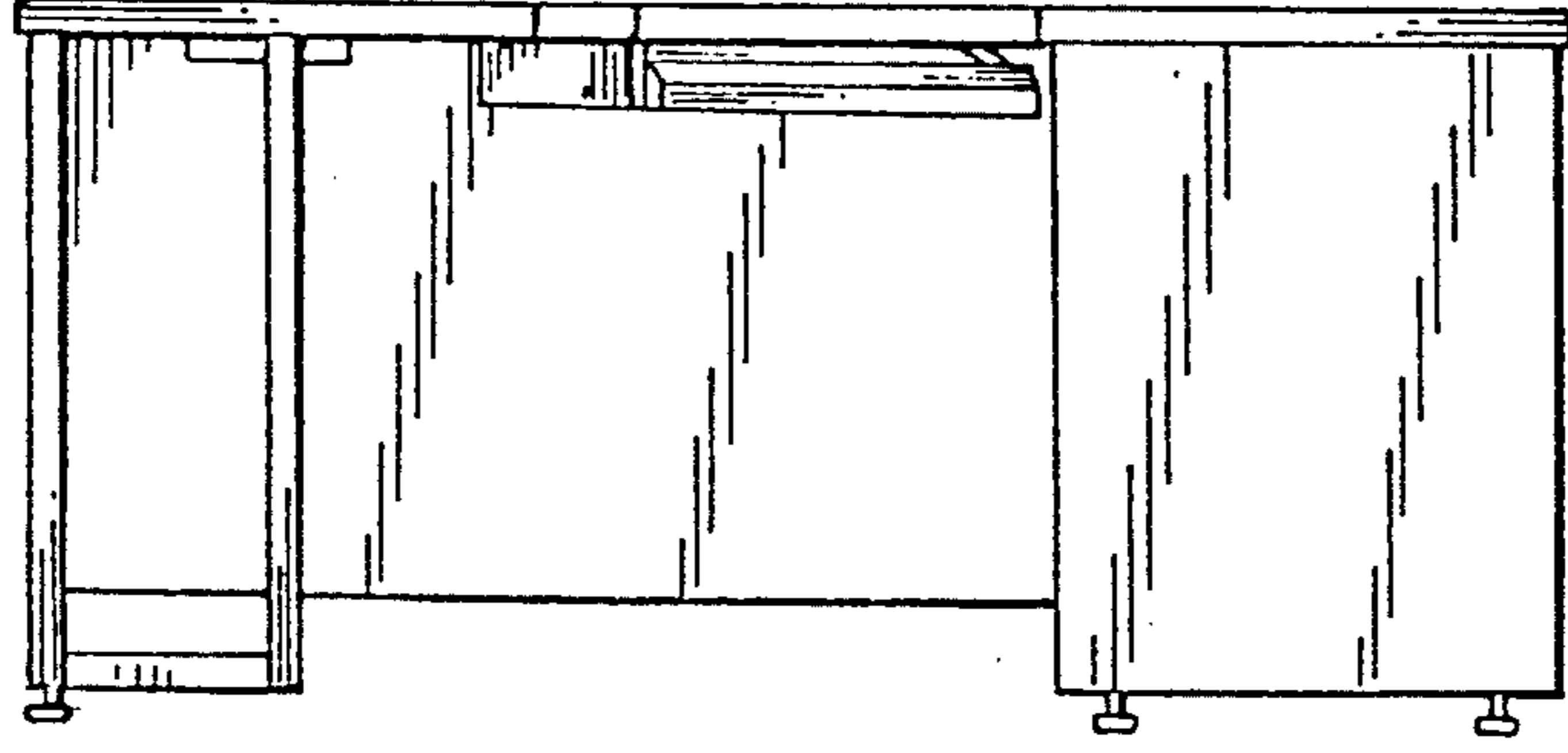

FIG. 22

FIG. 23

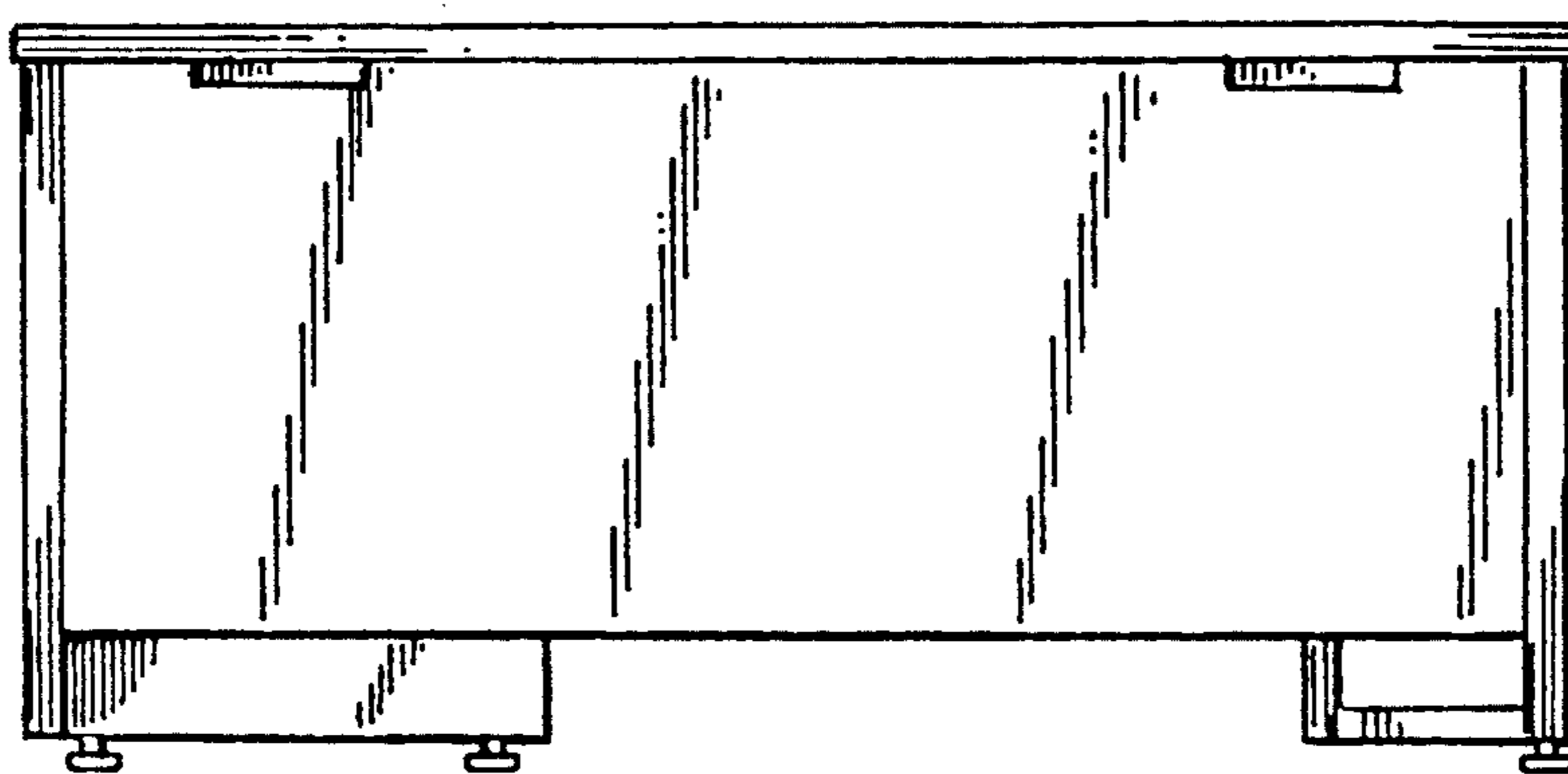

FIG. 24

