



US00D346894S

**United States Patent** [19]  
**Hatfield**

[11] **Patent Number: Des. 346,894**  
[45] **Date of Patent: \*\* May 17, 1994**

[54] **STRAP SYSTEM FOR A SHOE UPPER**

[75] **Inventor: Tinker L. Hatfield, Portland, Oreg.**

[73] **Assignee: Nike, Inc., Beaverton, Oreg.**

[\*] **Notice:** The portion of the term of this patent subsequent to May 10, 1994 has been disclaimed.

[\*\*] **Term: 14 Years**

[21] **Appl. No.: 2,418**

[22] **Filed: Dec. 11, 1992**

**Related U.S. Application Data**

[63] Continuation-in-part of Ser. No. 866,548, Apr. 10, 1992, Pat. No. Des. 337,425.

[52] **U.S. Cl. .... D2/973**

[58] **Field of Search .... D2/264, 265, 277, 275, D2/308-314; 36/7.7, 9, 11.5, 50, 83, 84, 89, 100-107, 110, 112-114, 117, 121, 132, 136**

[56] **References Cited**

**U.S. PATENT DOCUMENTS**

- D. 283,173 4/1986 Malone ..... D2/309
- D. 295,229 4/1988 Brown et al. .... D2/314
- D. 300,282 3/1989 Brown et al. .... D2/314
- D. 326,949 6/1992 Beckley ..... D2/314 X
- 177,396 3/1876 Harris .

(List continued on next page.)

**FOREIGN PATENT DOCUMENTS**

- 594774 2/1933 Fed. Rep. of Germany .
- 864069 1/1953 Fed. Rep. of Germany ..... 36/117

**OTHER PUBLICATIONS**

- Nike Spring 1986 Footwear Catalog, p. 9 (published May 1985).
- Nike Spring 1991 Footwear, pp. 18, 88, 90 (published May 1990).
- Nike Spring 1992 Footwear Catalog, pp. 34, 62 (published May 1991).
- Nike Fall 1992 Footwear Catalog, pp. 26, 38 (published Dec. 1991).

*Primary Examiner*—Louis S. Zarfes

*Attorney, Agent, or Firm*—Banner, Birch, McKie & Beckett

[57] **CLAIM**

The ornamental design for a strap system for a shoe upper, as shown and described.

**DESCRIPTION**

FIG. 1 is a side elevational view of one side of a strap system for a shoe upper showing a first embodiment of my new design;

FIG. 2 is a side elevational view of the other side of the strap system showing in FIG. 1;

FIG. 3 is a front elevational view of the strap system shown in FIG. 1;

FIG. 4 is a rear elevational view of the strap system shown in FIG. 1;

FIG. 5 is a top plan view of the strap system shown in FIG. 1;

FIG. 6 is a side elevational view of one side of a strap system for a shoe upper showing a second embodiment of my new design;

FIG. 7 is a side elevational view of the other side of the strap system shown in FIG. 6;

FIG. 8 is a front elevational view of the strap system shown in FIG. 6;

FIG. 9 is a rear elevational view of the strap system shown in FIG. 6;

FIG. 10 is a top plan view of the strap system shown in FIG. 6;

FIG. 11 is a side elevational view of one side of a strap system for a shoe upper showing a third embodiment of my new design;

FIG. 12 is a side elevational view of the other side of the strap system shown in FIG. 11;

FIG. 13 is a front elevational view of the strap system shown in FIG. 11;

FIG. 14 is a rear elevational view of the strap system shown in FIG. 11;

FIG. 15 is a top plan view of the strap system shown in FIG. 11 with the strap done; and,

FIG. 16 is a top plan view of the strap system shown in FIG. 11 with the straps undone.

The broken line showing of a shoe upper and sole periphery in the figures are for illustrative purposes and form no part of the claimed design.

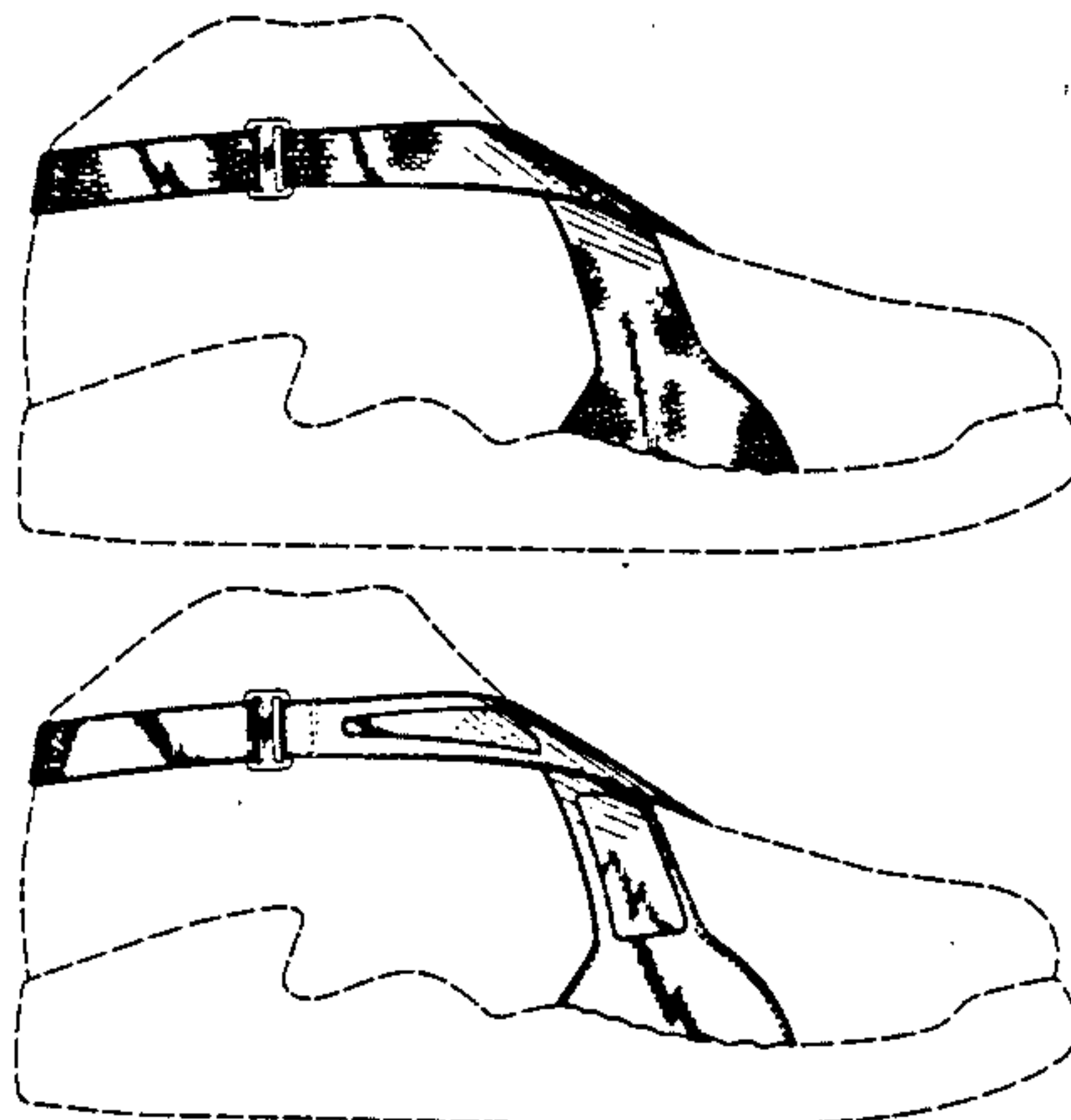

U.S. PATENT DOCUMENTS

1,283,335	10/1918	Shillcock .			
2,630,636	3/1953	Cockrell .....	36/9	4,441,265	4/1984 Burns et al. .... 36/117
3,327,410	6/1967	Park, Sr. et al. ....	36/89	4,446,856	5/1984 Jordan .
4,005,533	2/1977	Anderson et al. ....	36/7.7	4,547,981	10/1985 Thais .....
4,130,949	12/1978	Seidel .....	36/50	4,567,678	2/1986 Morgan et al. .... 36/110
4,200,997	5/1980	Scheinhaus et al. ....	36/11.5	4,577,419	3/1986 Chassaing .....
4,282,659	8/1981	Bourque et al. ....	36/121	4,621,648	11/1986 Ivany .....
4,308,672	1/1982	Antonious .....	D2/314 X	4,640,025	2/1987 DeRenzo .....
4,313,433	2/1982	Cramer .		4,676,011	6/1987 O'Rourke et al. .... 36/89
4,414,759	11/1983	Morgan et al. ....	36/11.5	4,793,075	12/1988 Thatcher .....
				4,811,502	3/1989 Barrett .....
				4,817,589	4/1989 Wertz .....
				5,014,448	5/1991 Perrone .....

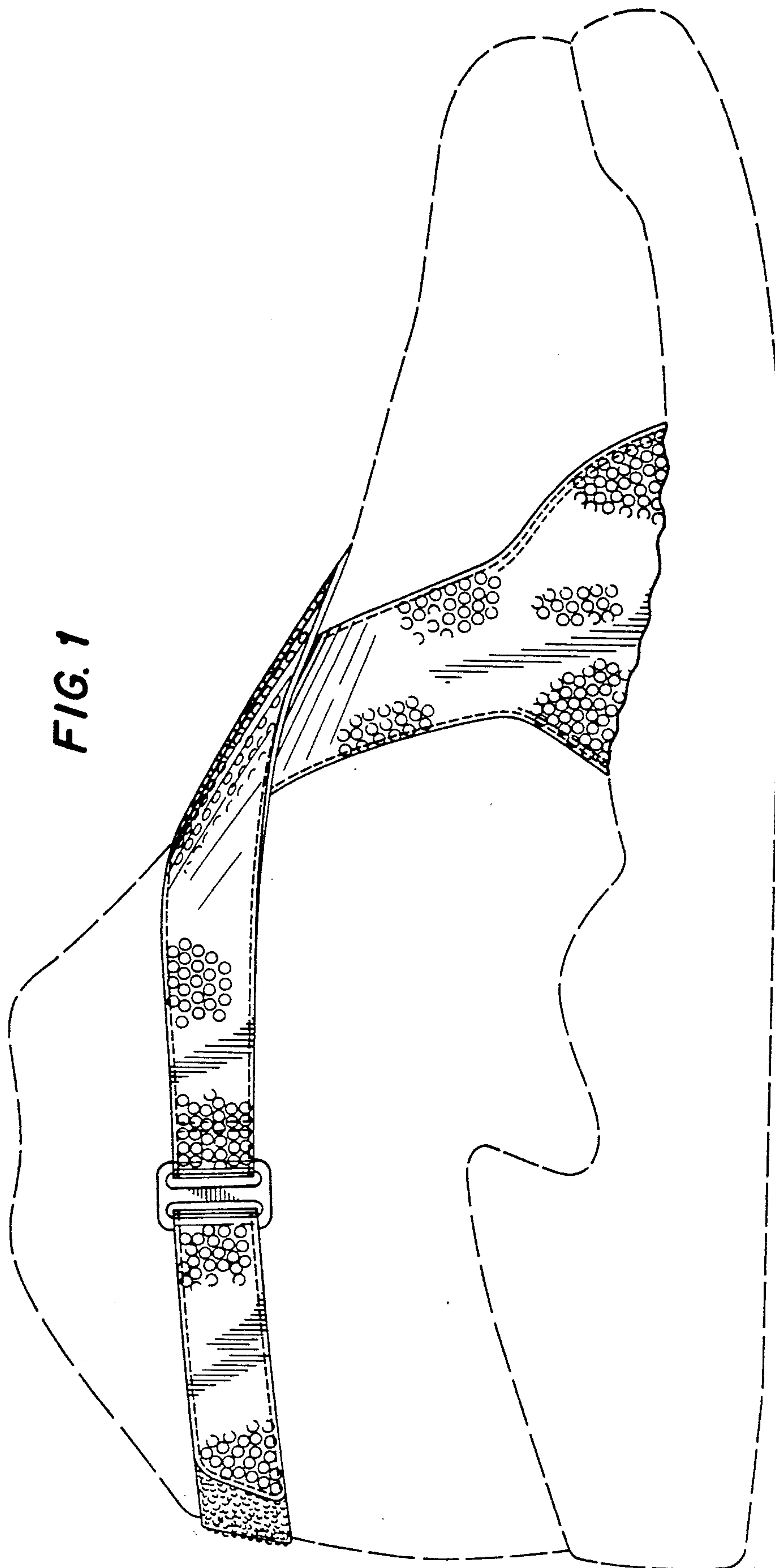

FIG. 1



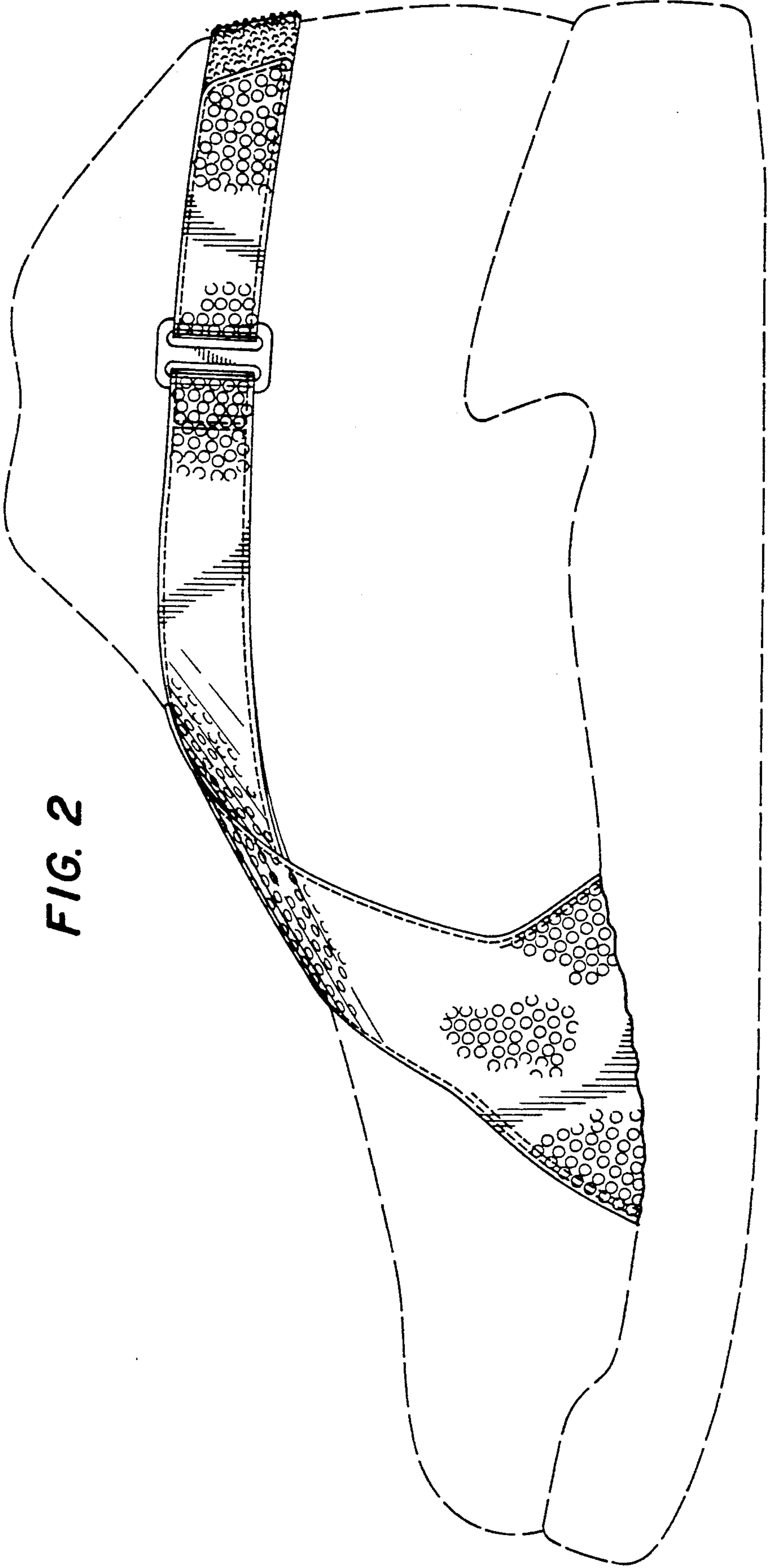

FIG. 2

FIG. 4

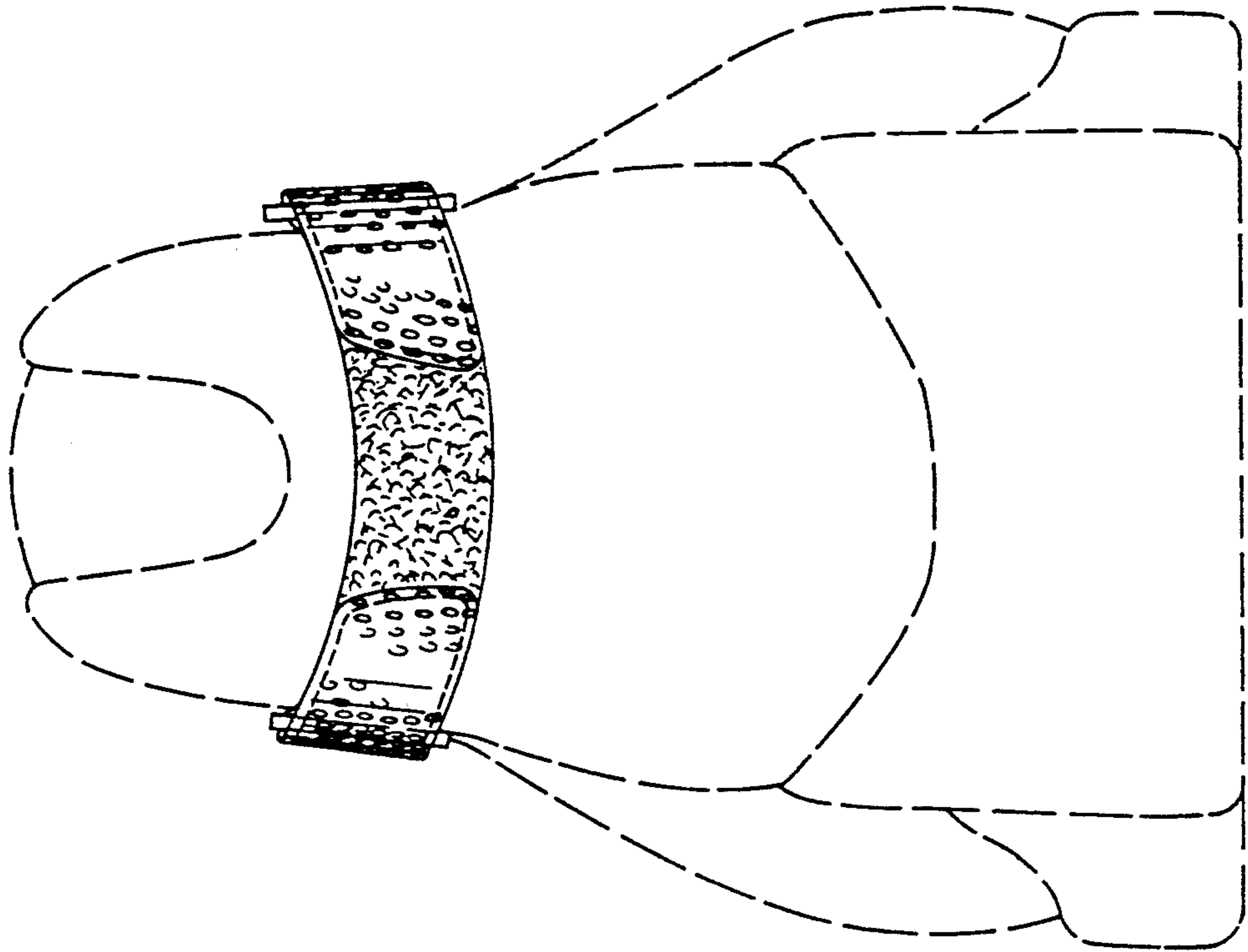

FIG. 3

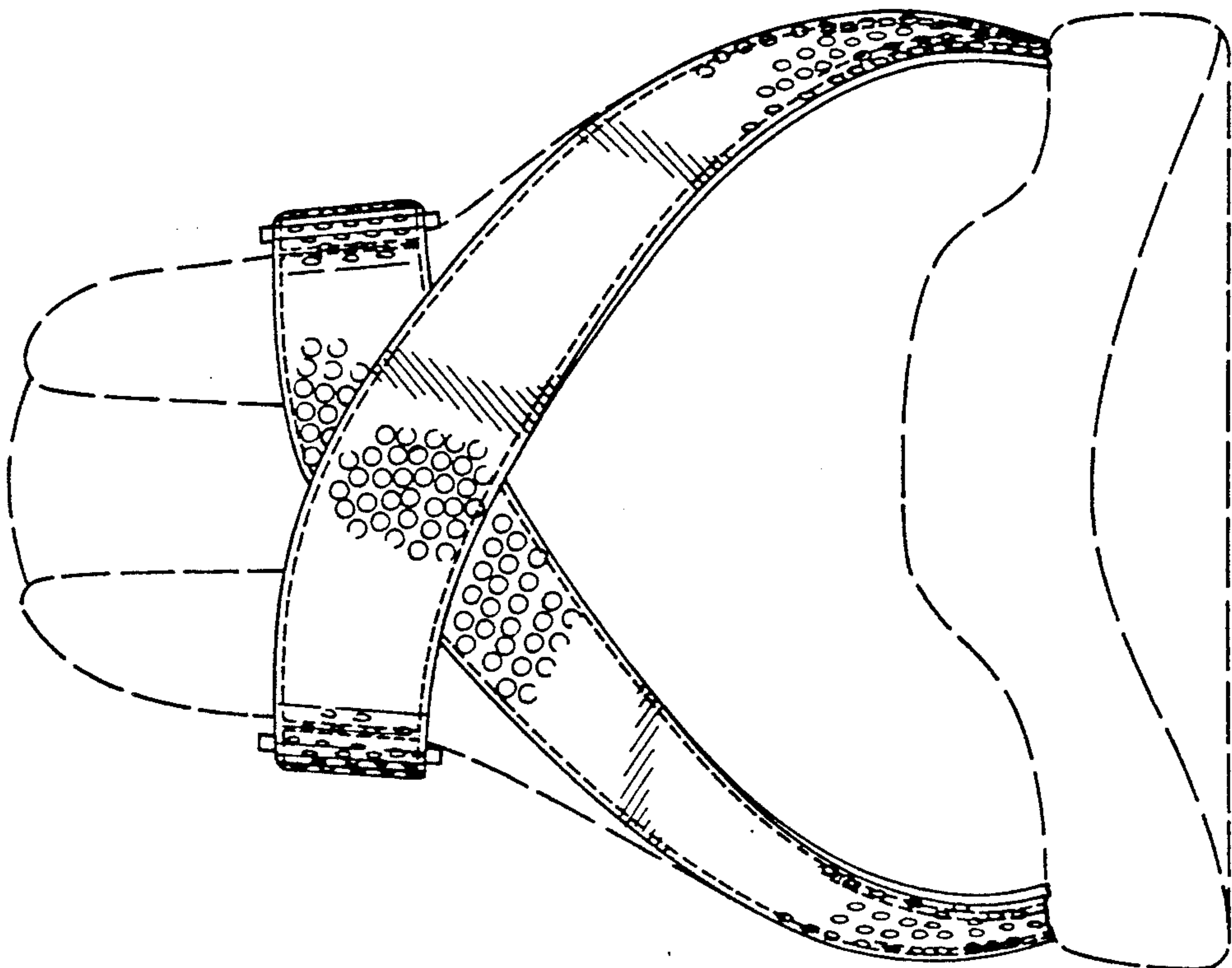

FIG. 5

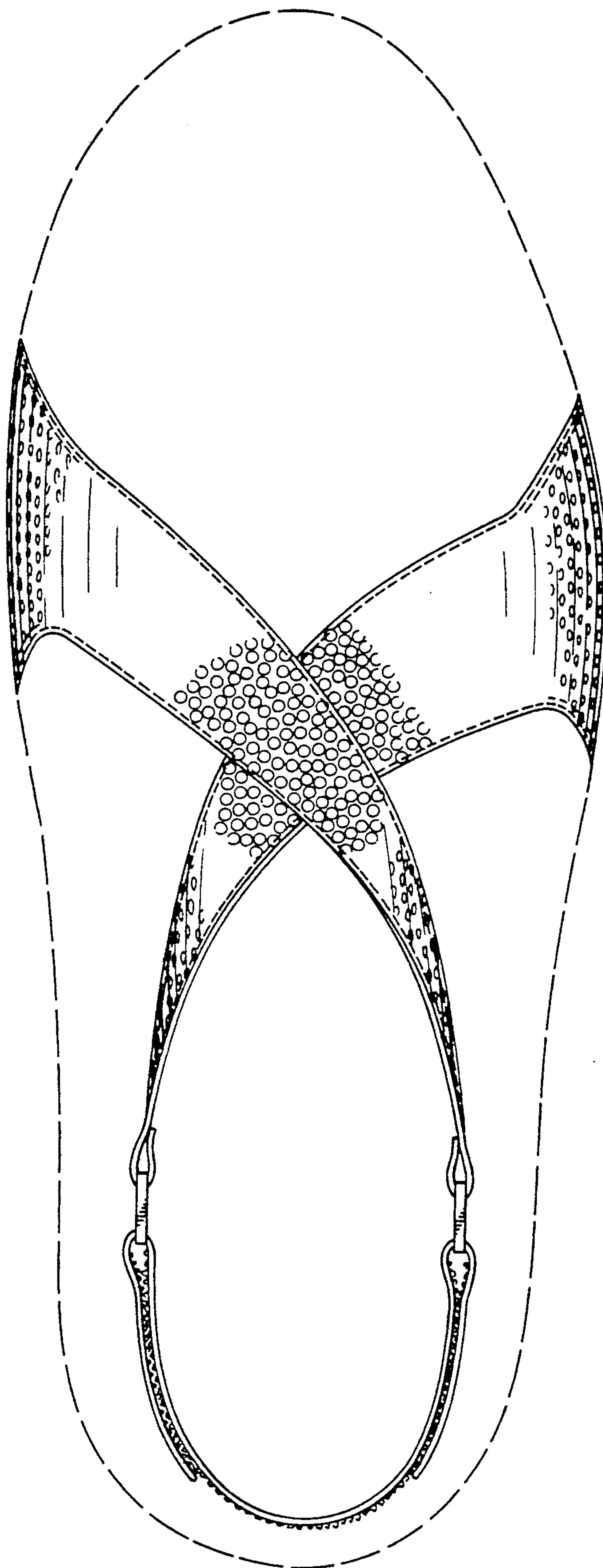
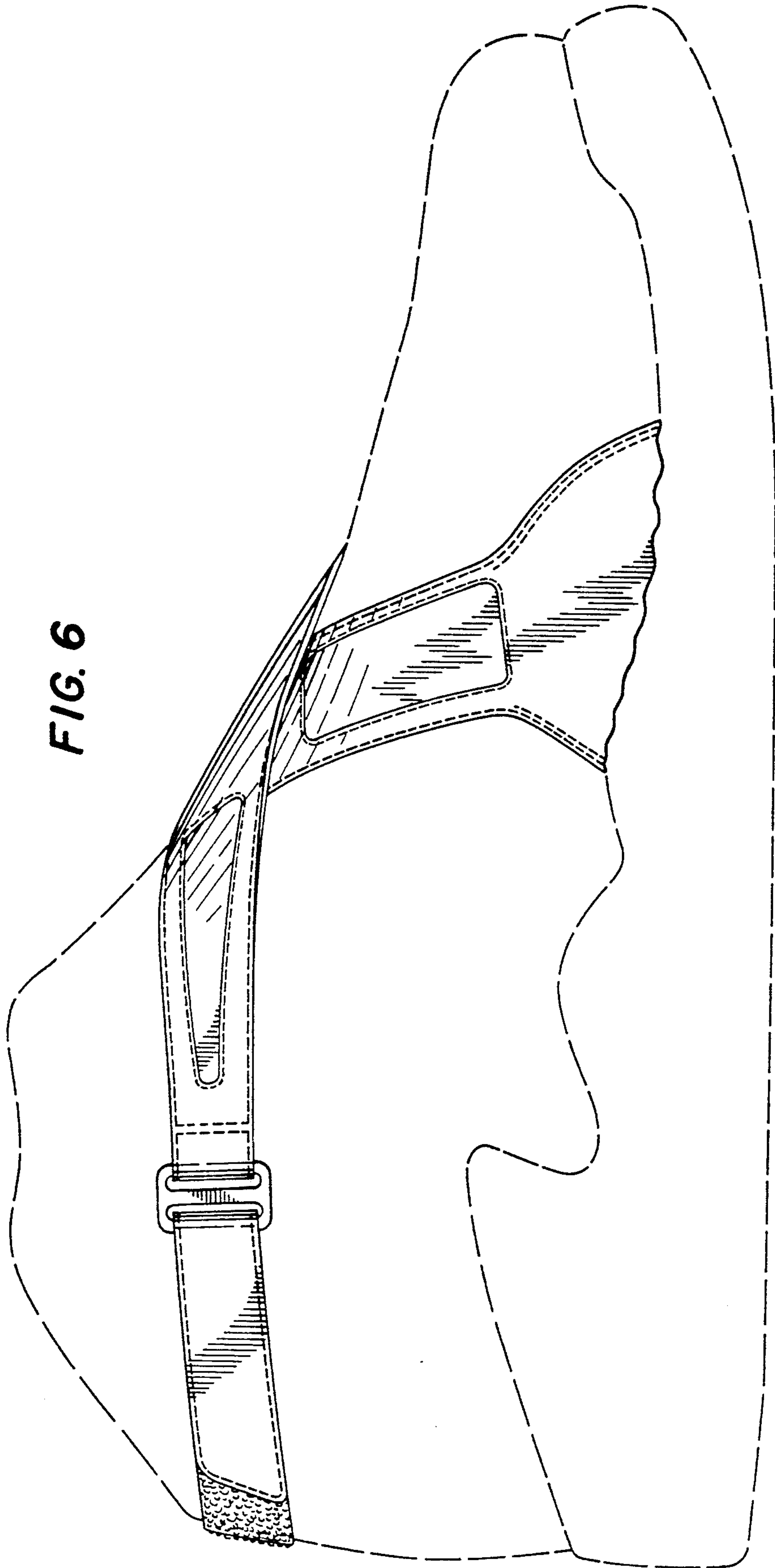

FIG. 6



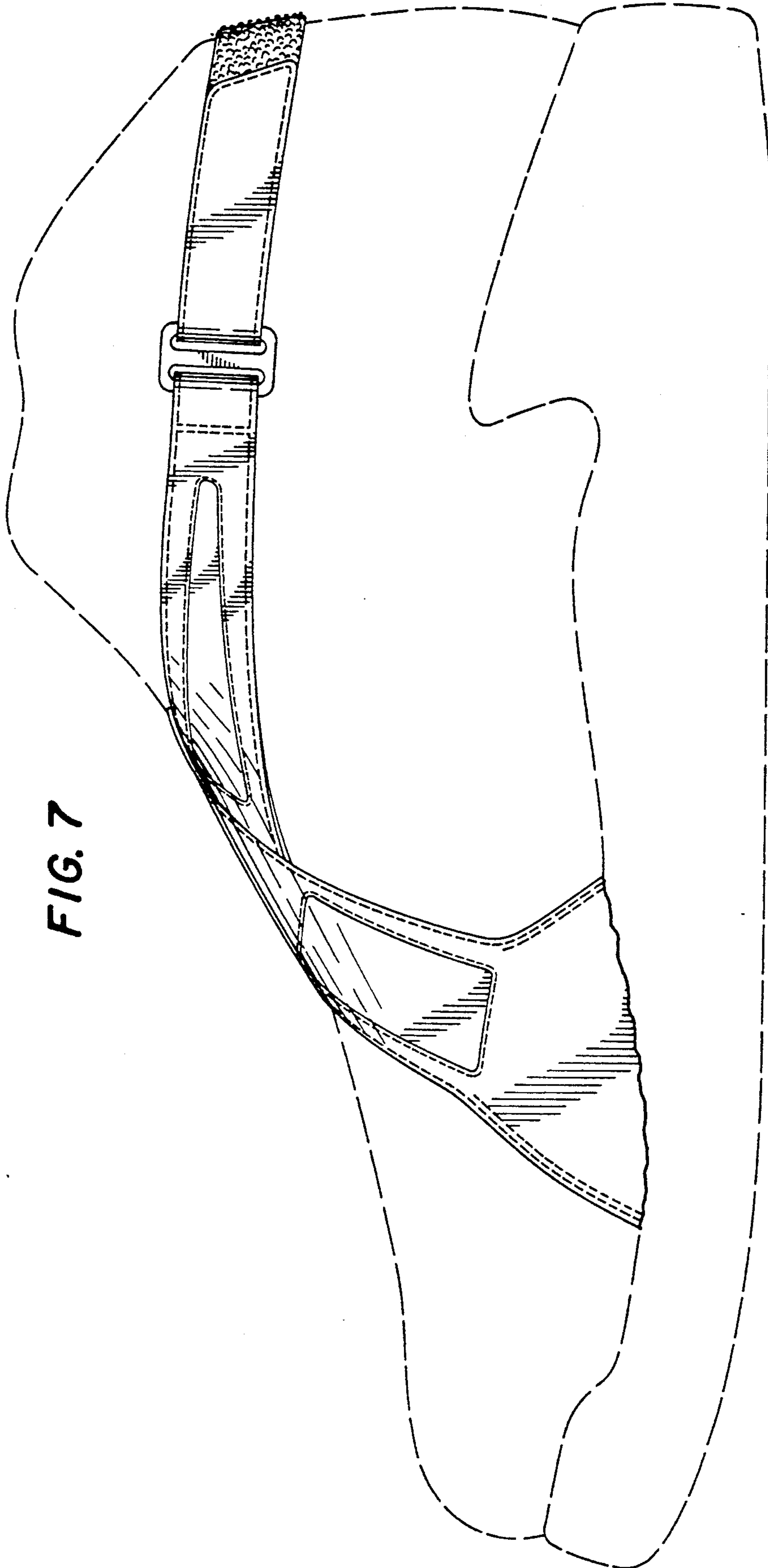

FIG. 7



FIG. 9

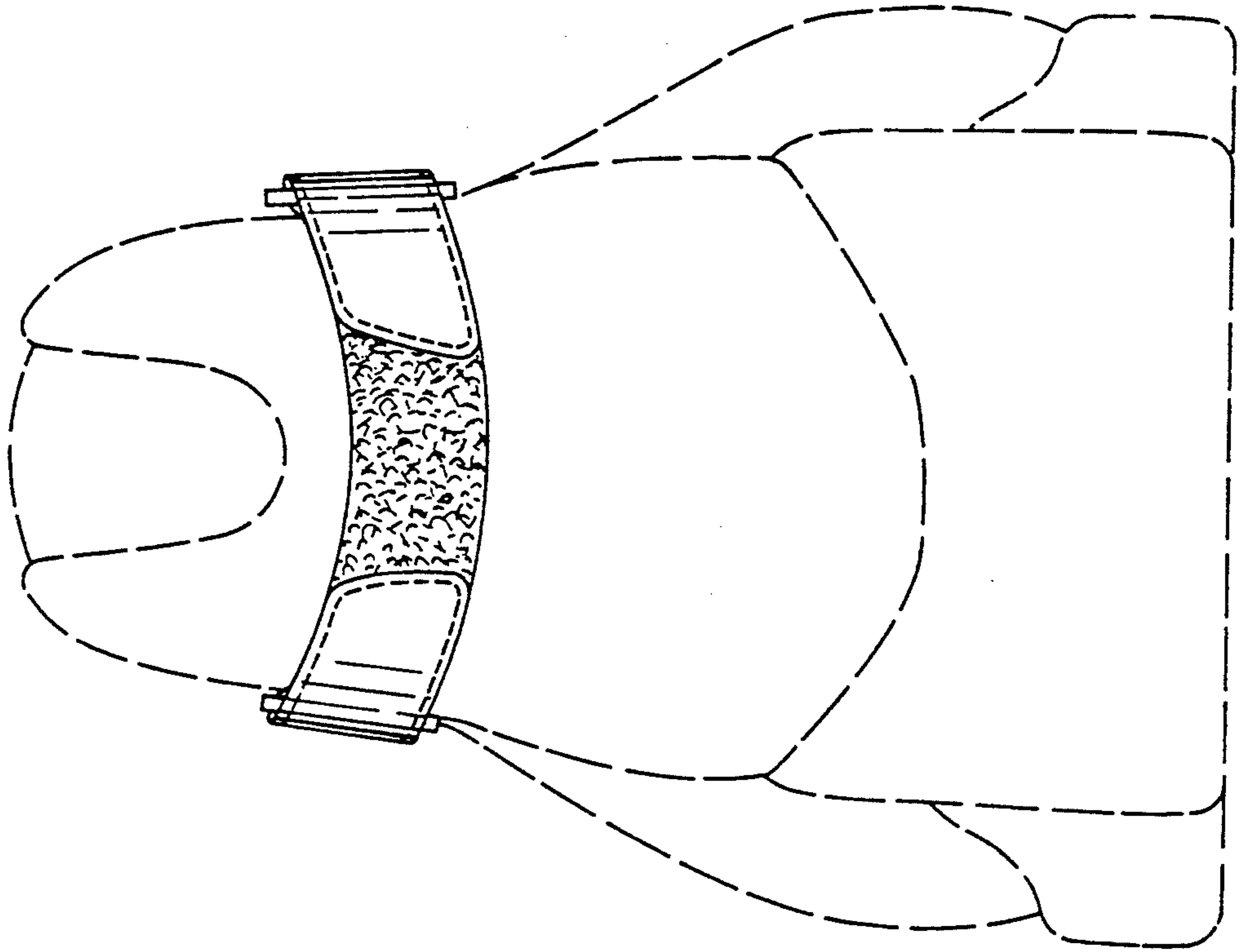

FIG. 8

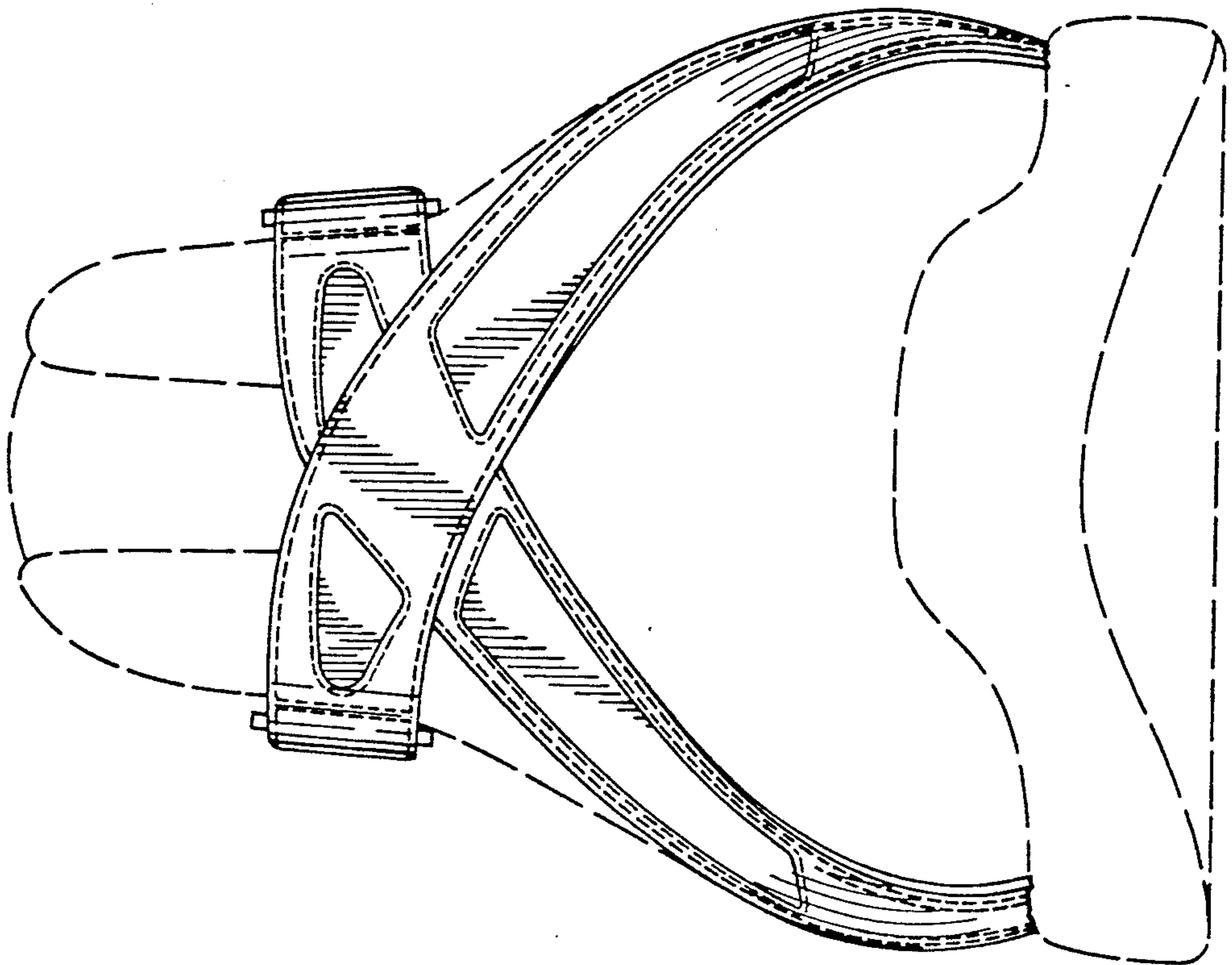

FIG. 10

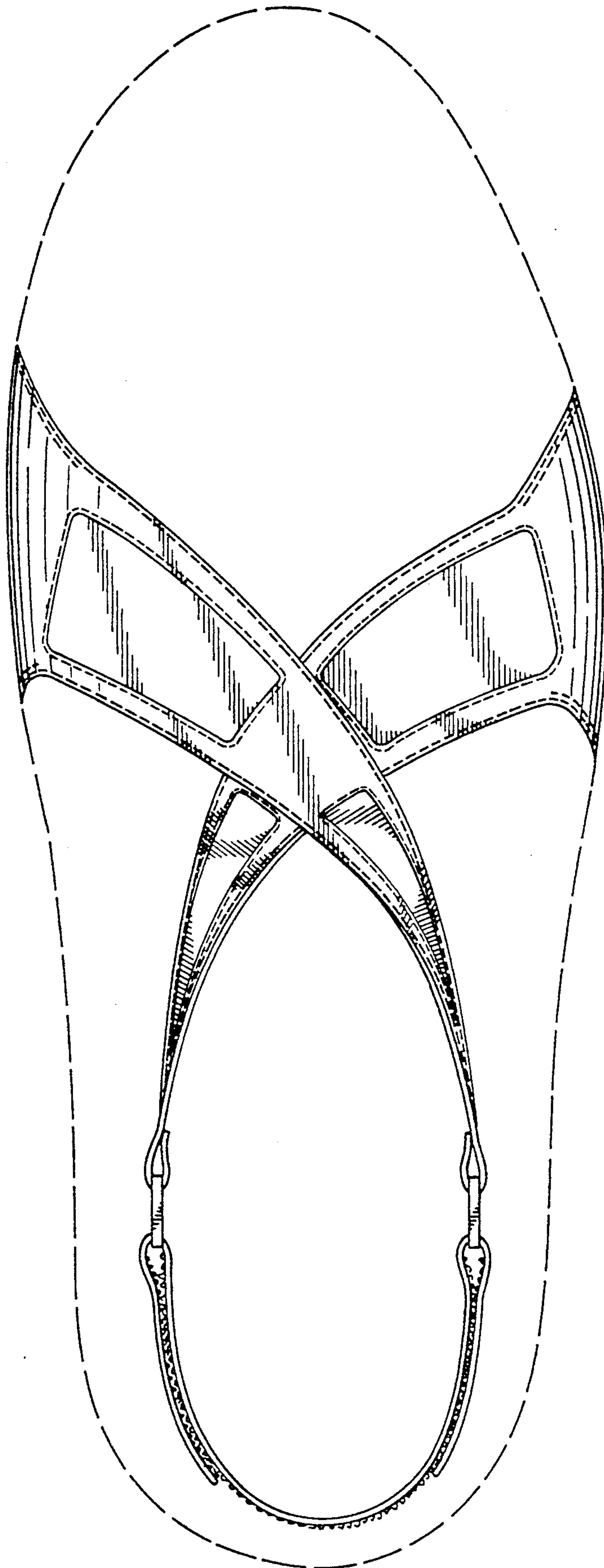
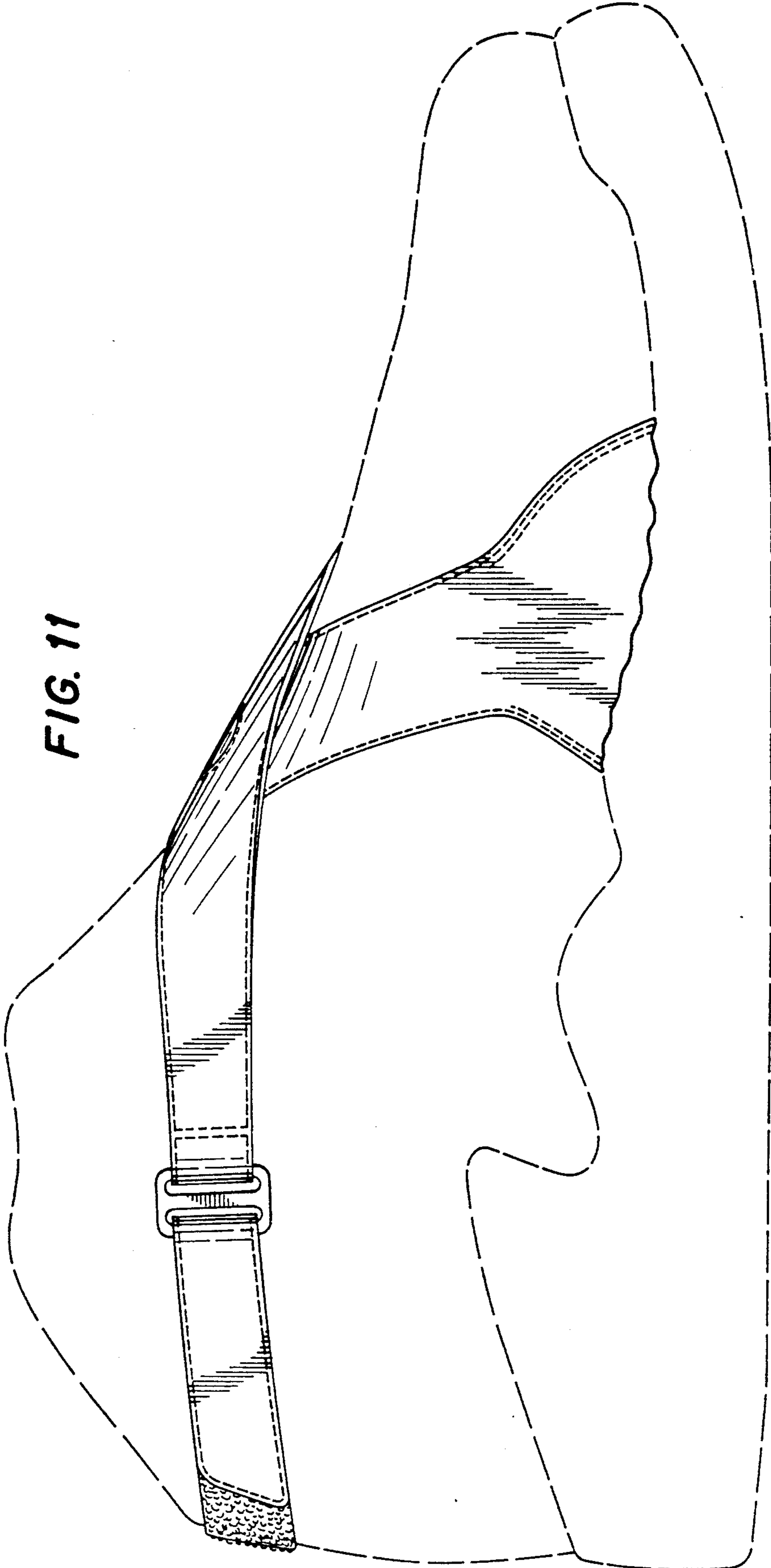

FIG. 11



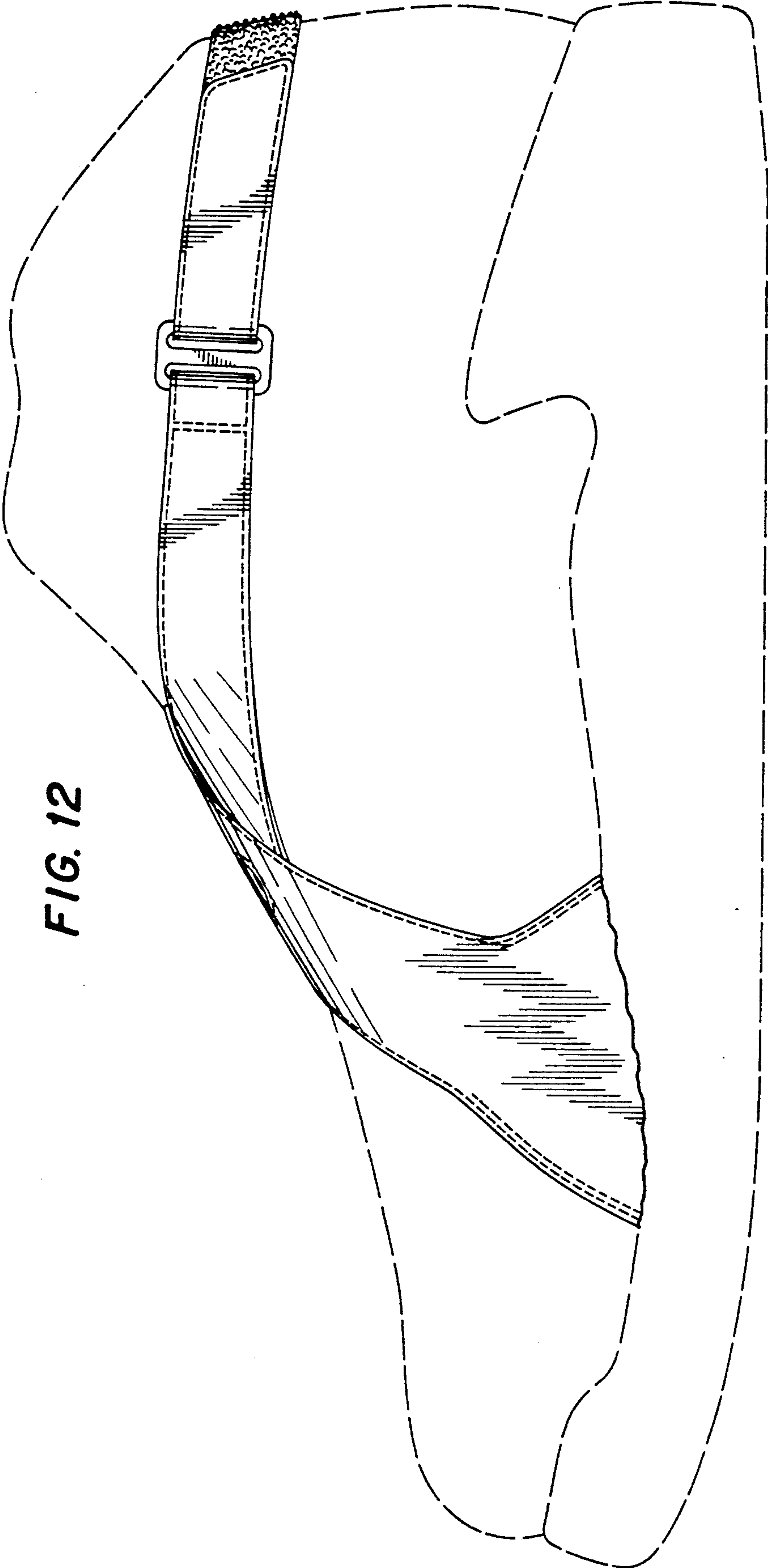
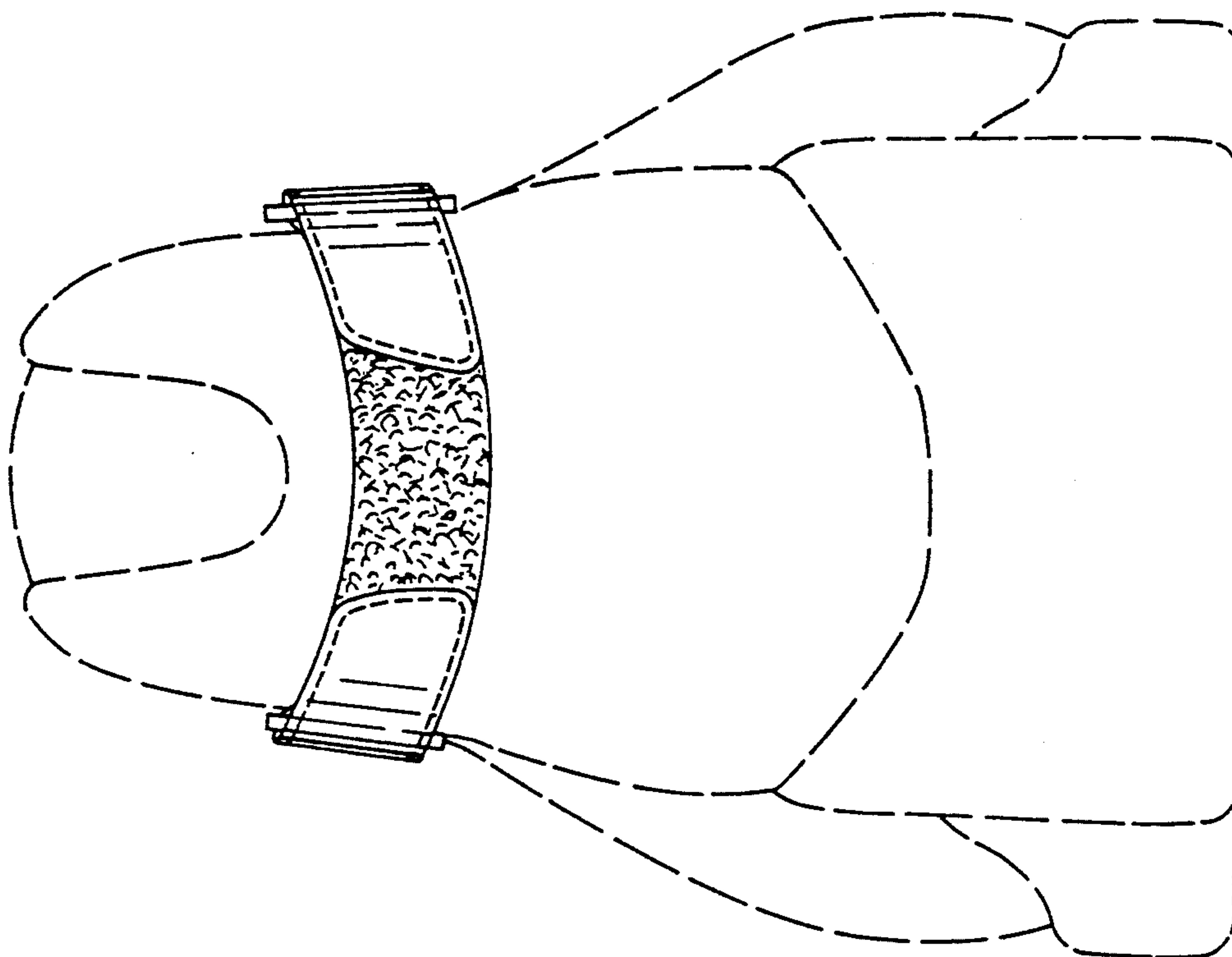

FIG. 12



**FIG. 14**



**FIG. 13**

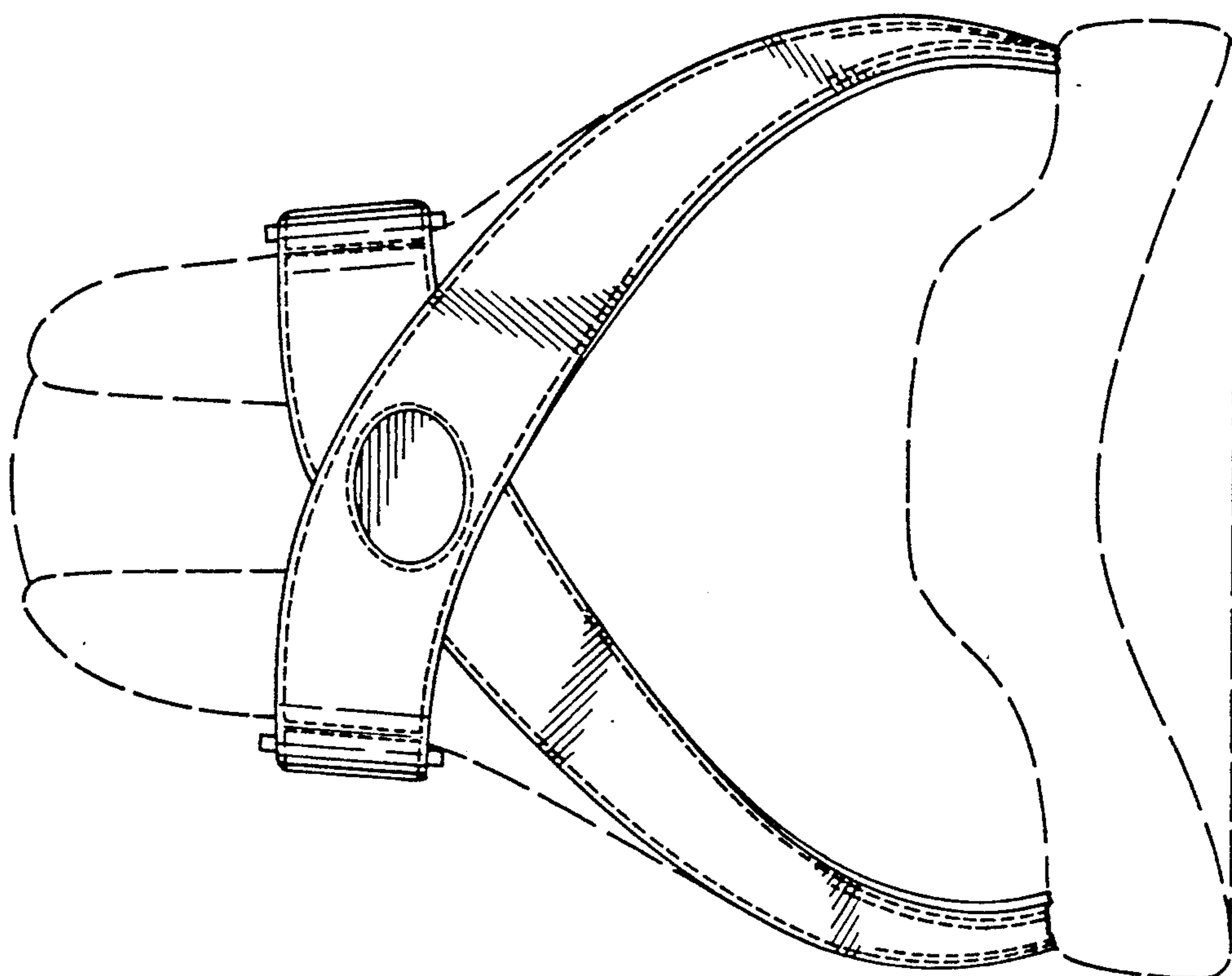

FIG. 15

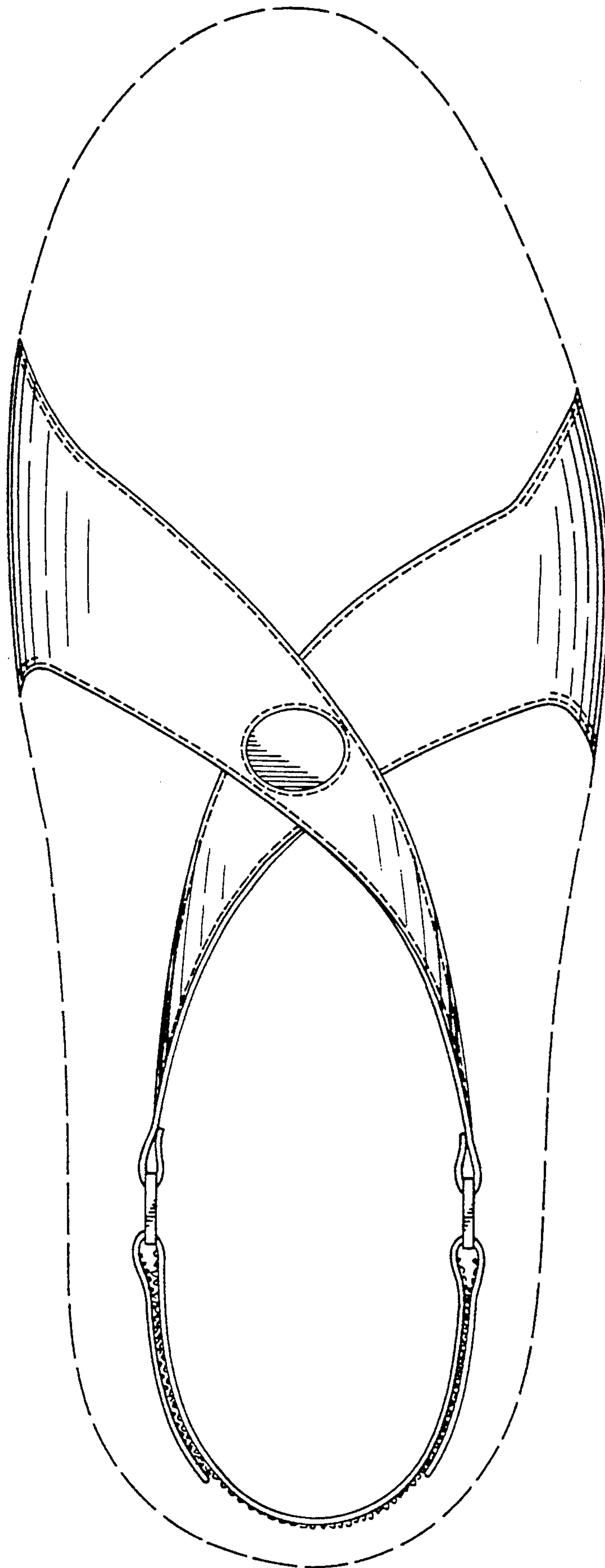
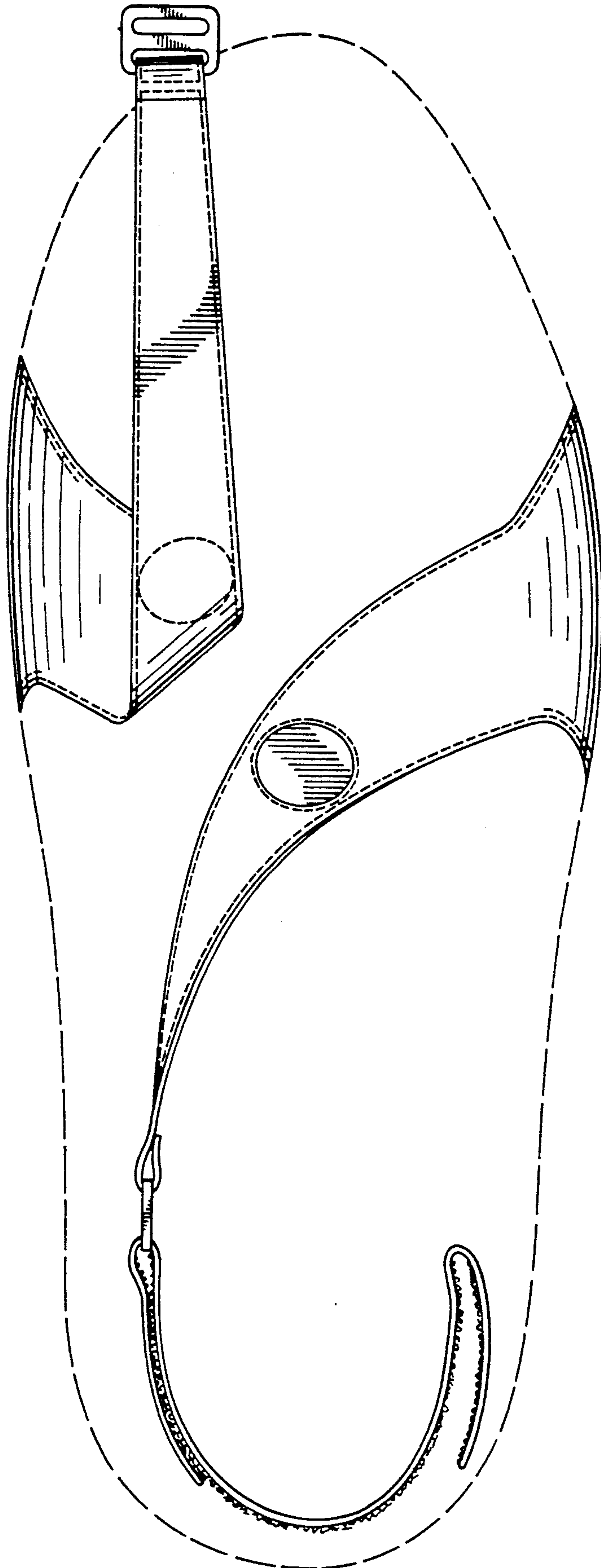

FIG. 16



UNITED STATES PATENT AND TRADEMARK OFFICE  
**CERTIFICATE OF CORRECTION**

PATENT NO. : Des. 346,894  
DATED : May 17, 1994  
INVENTOR(S) : Tinker L. Hatfield

Page 1 of 1

It is certified that error appears in the above-identified patent and that said Letters Patent is hereby corrected as shown below:

Title page.

Item [\*] Notice, "May 10, 1004" should be -- May 10, 2008 --.

Signed and Sealed this

Twenty-fifth Day of April, 2006

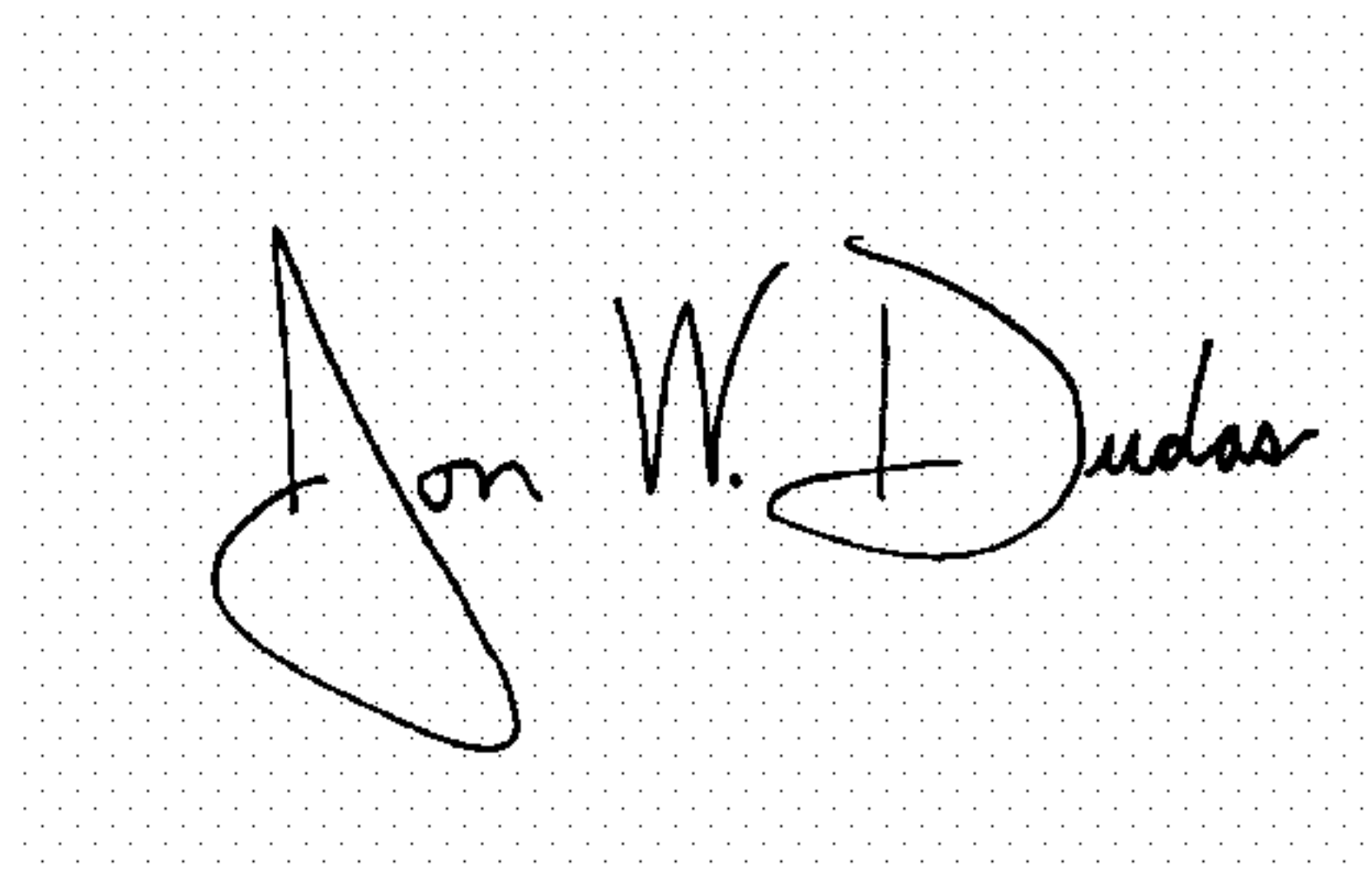
A handwritten signature in black ink on a light gray dotted background. The signature reads "Jon W. Dudas" in a cursive style.

JON W. DUDAS

*Director of the United States Patent and Trademark Office*