



US00D346852S

United States Patent [19]
Hill

[11] **Patent Number: Des. 346,852**
[45] **Date of Patent: ** May 10, 1994**

[54] **FAUCET BODY**

[75] **Inventor: Loran R. Hill, Indianapolis, Ind.**

[73] **Assignee: Masco Corporation of Indiana, Taylor, Mich.**

[**] **Term: 14 Years**

[21] **Appl. No.: 823,650**

[22] **Filed: Jan. 22, 1992**

[52] **U.S. Cl. D23/241**

[58] **Field of Search 137/606, 801;
4/675-678; D23/238-243**

[56] **References Cited**

U.S. PATENT DOCUMENTS

D. 181,595	12/1957	McLean	D23/241
D. 190,791	6/1961	Kohler	D23/241
D. 200,042	1/1965	MacKay et al.	D23/241
D. 229,495	12/1973	Landell	D23/241
D. 323,877	2/1992	Haug et al. .	
2,474,108	6/1949	Kadish	137/606
2,546,327	3/1951	Young	137/606 X
3,448,768	6/1969	Keller, III	137/606
4,290,445	9/1981	Turner	137/801 X

OTHER PUBLICATIONS

Catalog entitled "Delta HDF" Commercial Products Catalog, one page unnumbered. ©1987.
Peerless Faucet Full Line Catalog, three pages unnumbered. ©1989.

Primary Examiner—James R. Largen
Attorney, Agent, or Firm—Myron B. Kapustij; Malcolm L. Sutherland

[57] **CLAIM**

The ornamental design for a faucet body, as shown and described.

DESCRIPTION

FIG. 1 is a top perspective view of a faucet body showing my new design;
FIG. 2 is a front elevational view thereof;
FIG. 3 is a rear elevational view thereof;
FIG. 4 is a left side elevational view thereof;
FIG. 5 is a right side elevational view thereof; and,
FIG. 6 is a top plan view thereof.
The broken line representation of the lift rod in FIGS. 1, 3, 4, 5 and 6 and of the aerator in FIGS. 1, 2, 4 and 5 are for purposes of illustration only and form no part of the claimed design.

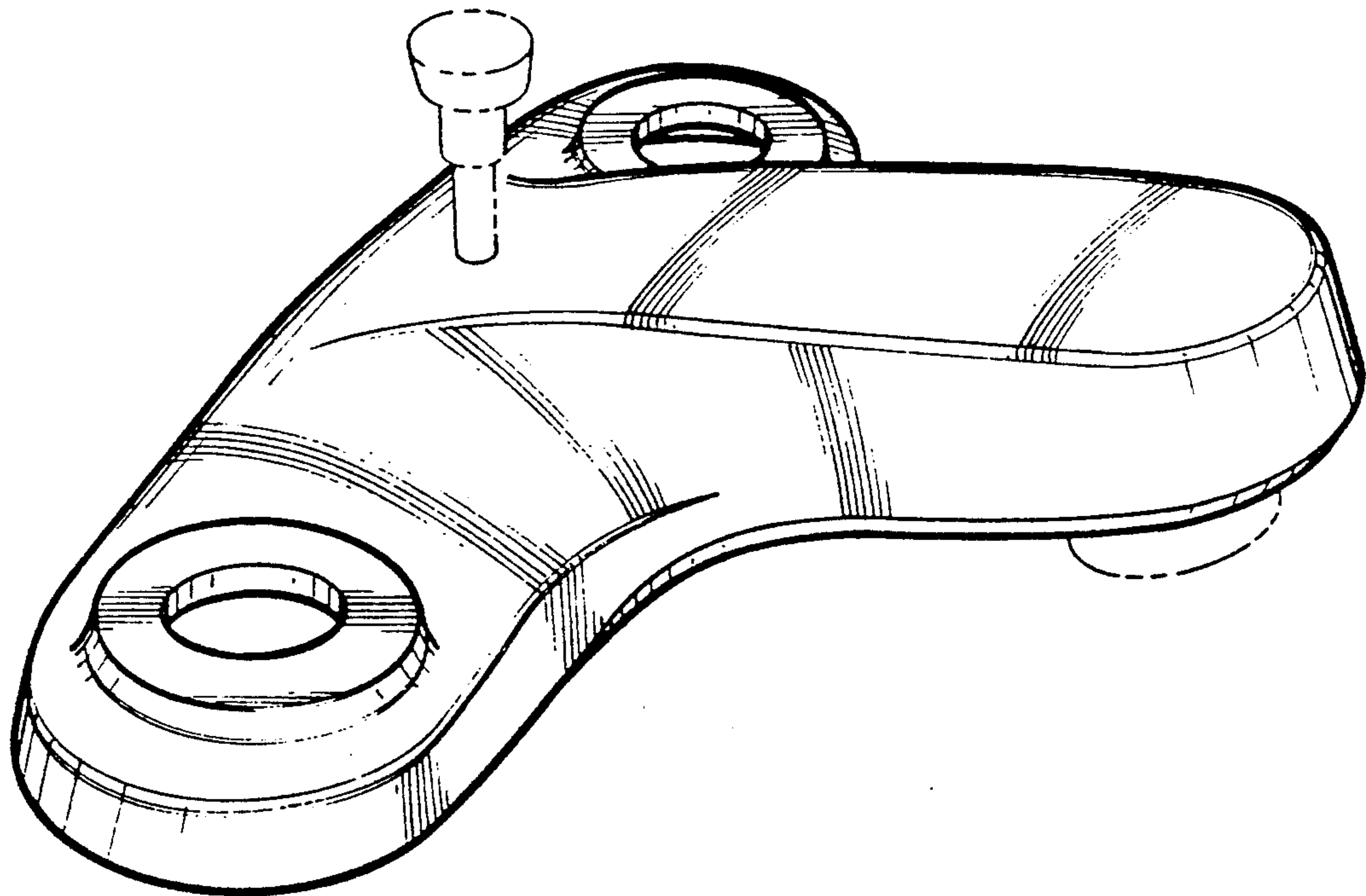

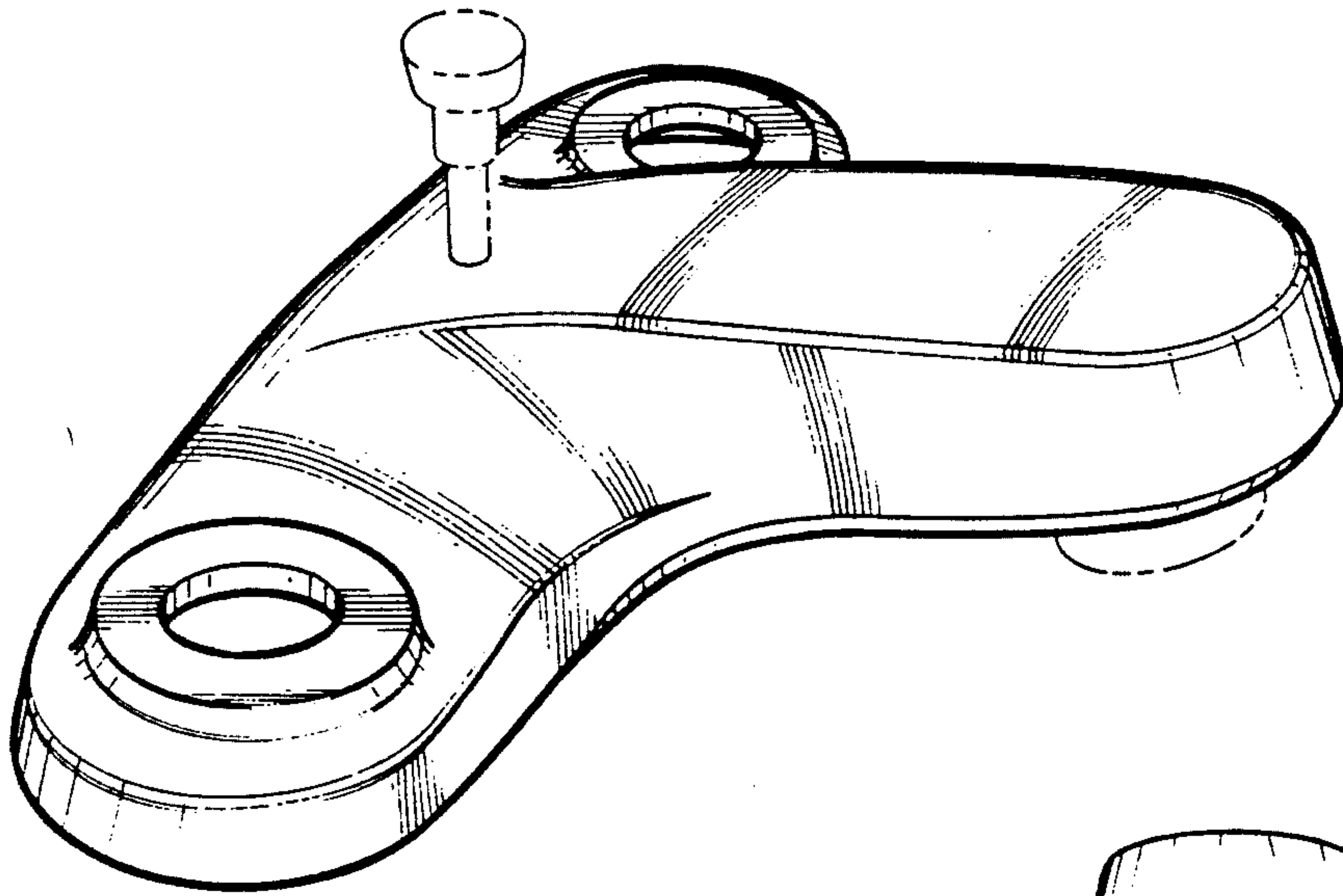

Fig-1

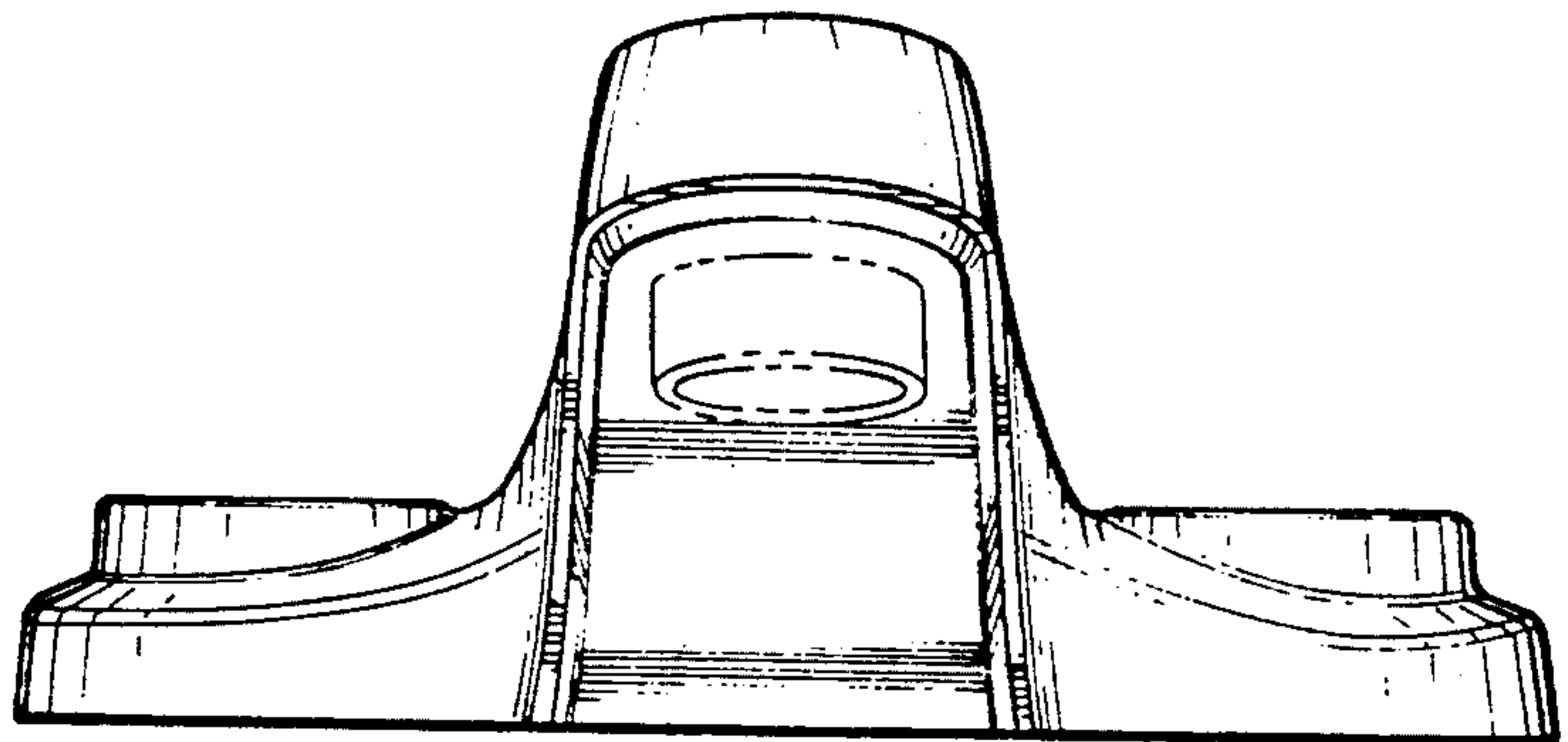

Fig-2

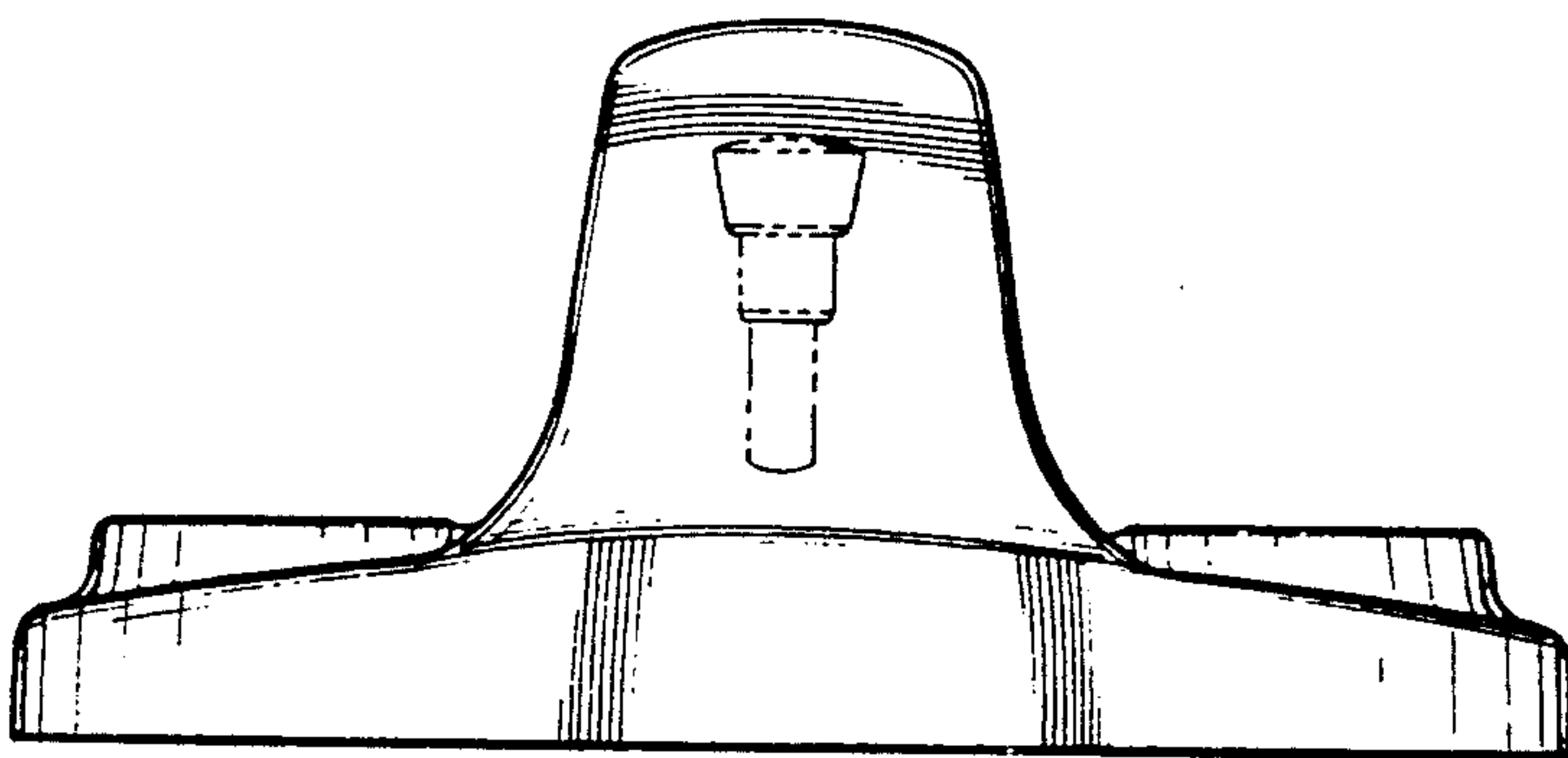

Fig-3

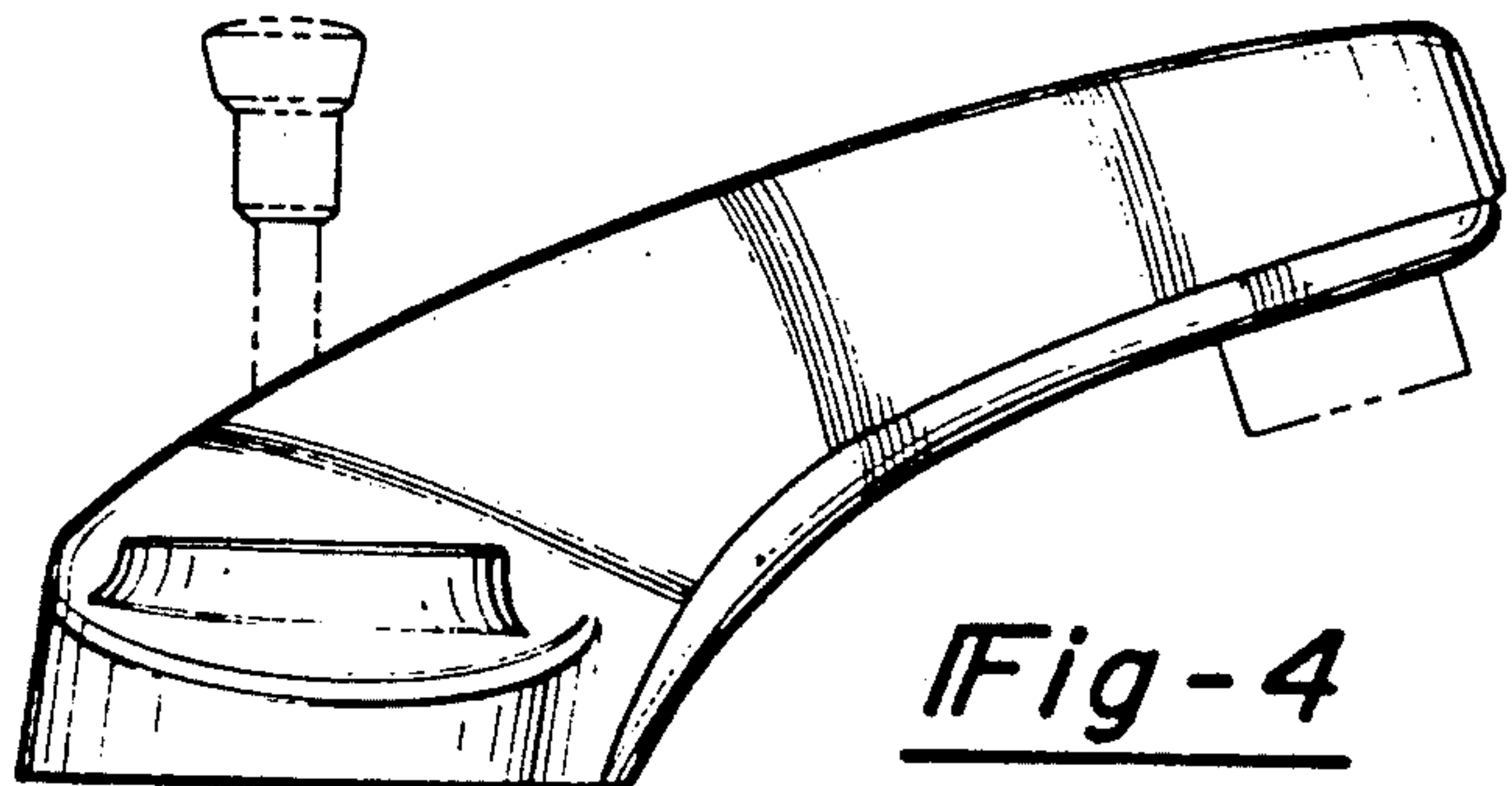

Fig-4

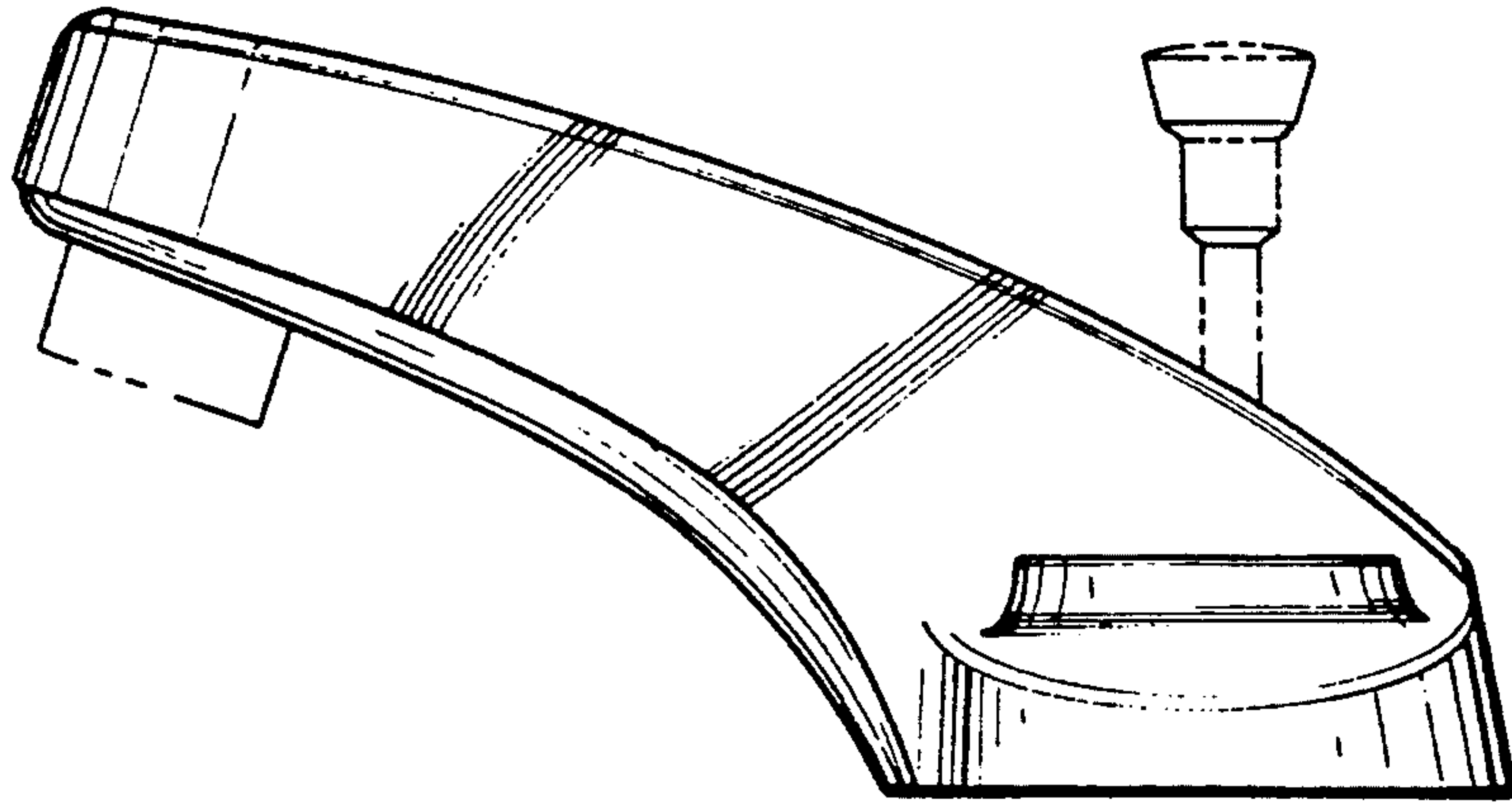

Fig-5

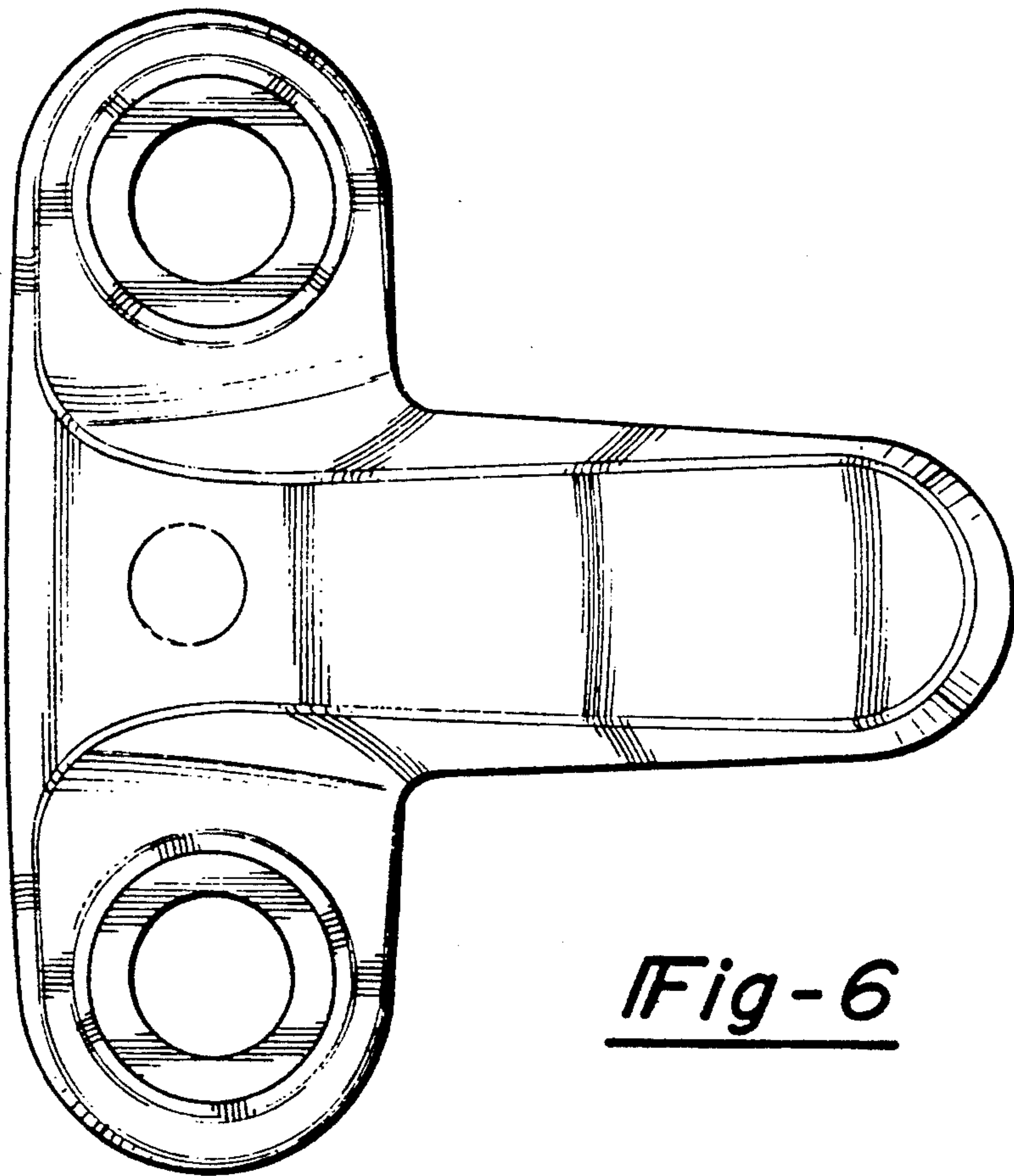

Fig-6