



US00D346849S

United States Patent [19]
Yamamoto et al.

[11] **Patent Number: Des. 346,849**
[45] **Date of Patent: ** May 10, 1994**

[54] **LINE GUIDE FOR FISHING RODS**
[75] **Inventors: Shigeru Yamamoto; Shuichi Kimura,**
both of Higashikurume, Japan
[73] **Assignee: Daiwa Seiko, Inc., Tokyo, Japan**
[**] **Term: 14 Years**
[21] **Appl. No.: 875,141**
[22] **Filed: Apr. 29, 1992**

509742 11/1982 Japan .
505890 10/1983 Japan .
509742 6/1984 Japan .
509742 6/1984 Japan .
496896 3/1985 Japan .
496896 3/1986 Japan .
505953 11/1988 Japan .
505953 11/1988 Japan .
751220 12/1988 Japan .
496896 3/1989 Japan .

[30] **Foreign Application Priority Data**
Nov. 1, 1991 [JP] Japan 3-33220
[52] **U.S. Cl. D22/143**
[58] **Field of Search 43/24; D22/143**

Primary Examiner—A. Hugo Word
Assistant Examiner—Doris V. Coles
Attorney, Agent, or Firm—Cushman, Darby & Cushman

[56] **References Cited**
U.S. PATENT DOCUMENTS
D. 237,175 10/1975 Ohmura D22/143
D. 256,714 9/1980 Ohmura D22/143
D. 256,718 9/1980 Ohmura D22/143
D. 271,127 10/1983 Ohmura D22/143
D. 280,656 9/1985 Ohmura D22/143
4,141,132 2/1979 Ohmura 43/24

[57] **CLAIM**
The ornamental design for a line guide for fishing rods,
as shown and described.

FOREIGN PATENT DOCUMENTS

496896 3/1979 Japan .
505890 7/1979 Japan .
505890 7/1979 Japan .
505953 7/1979 Japan .
509742 8/1979 Japan .
496896 10/1979 Japan .
509742 4/1981 Japan .
496896 11/1982 Japan .

DESCRIPTION

FIG. 1 is a front, top and right side of the perspective view of a line guide for fishing rods showing our new design;
FIG. 2 is a front elevational view thereof;
FIG. 3 is a left side elevational view thereof;
FIG. 4 is a right side elevational view thereof;
FIG. 5 is a top plan view thereof;
FIG. 6 is a bottom view thereof;
FIG. 7 is a front, top and right side of the perspective view of the other embodiment showing our new design;
FIG. 8 is a front elevational view thereof;
FIG. 9 is a left side elevational view thereof;
FIG. 10 is a right side elevational view thereof;
FIG. 11 is a top plan view thereof; and,
FIG. 12 is a bottom view thereof.

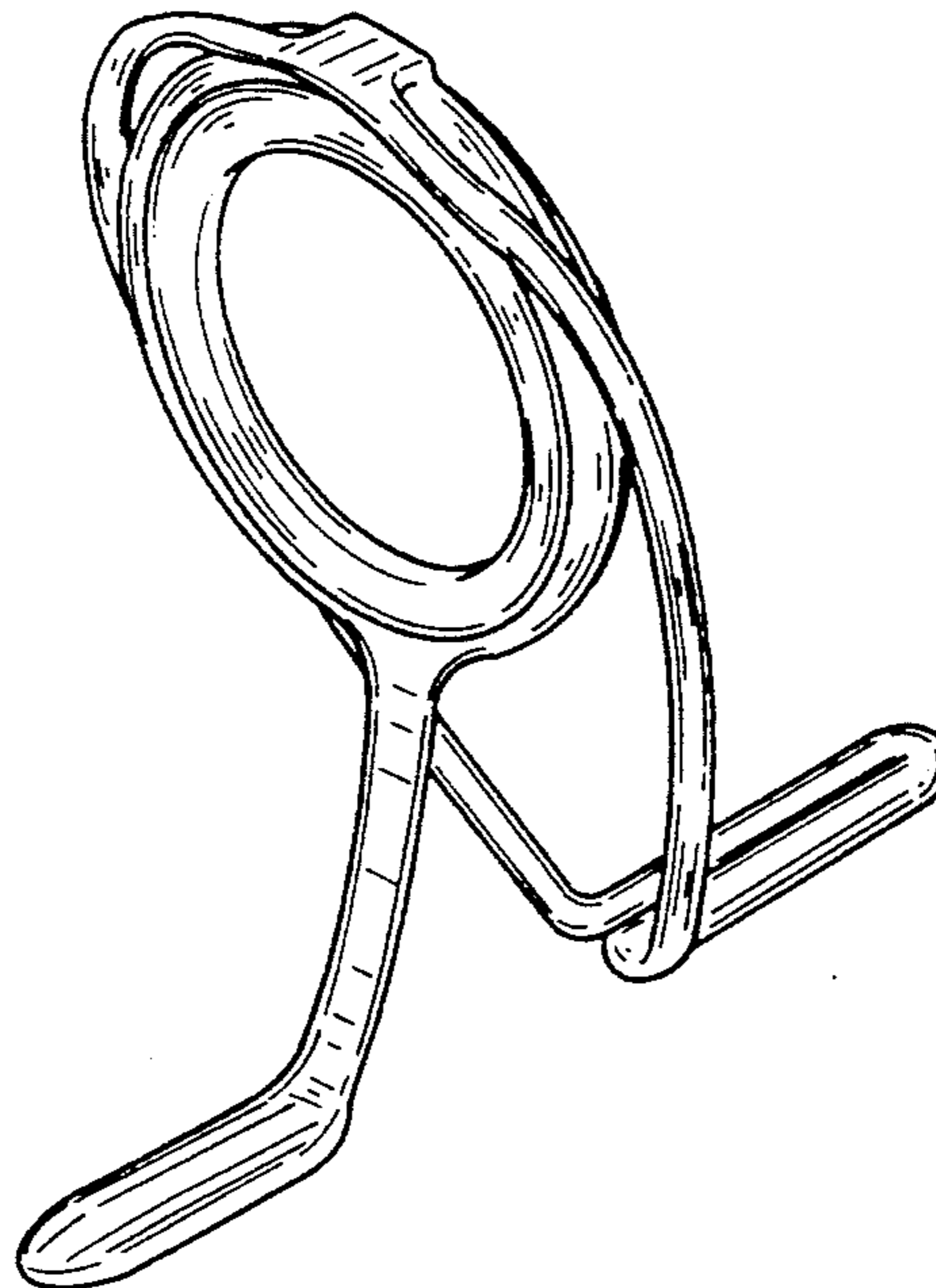

Fig. 1

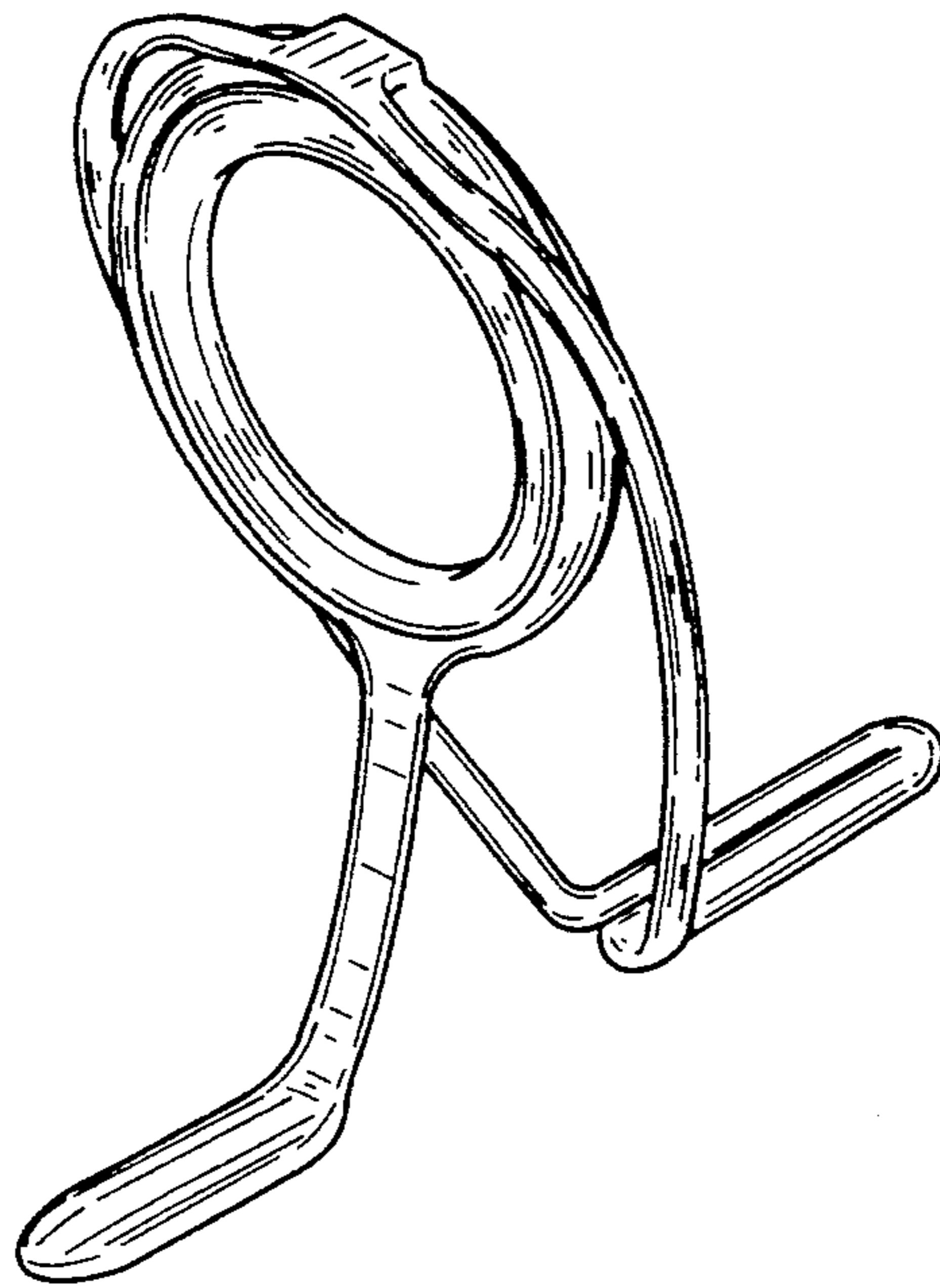

Fig. 2

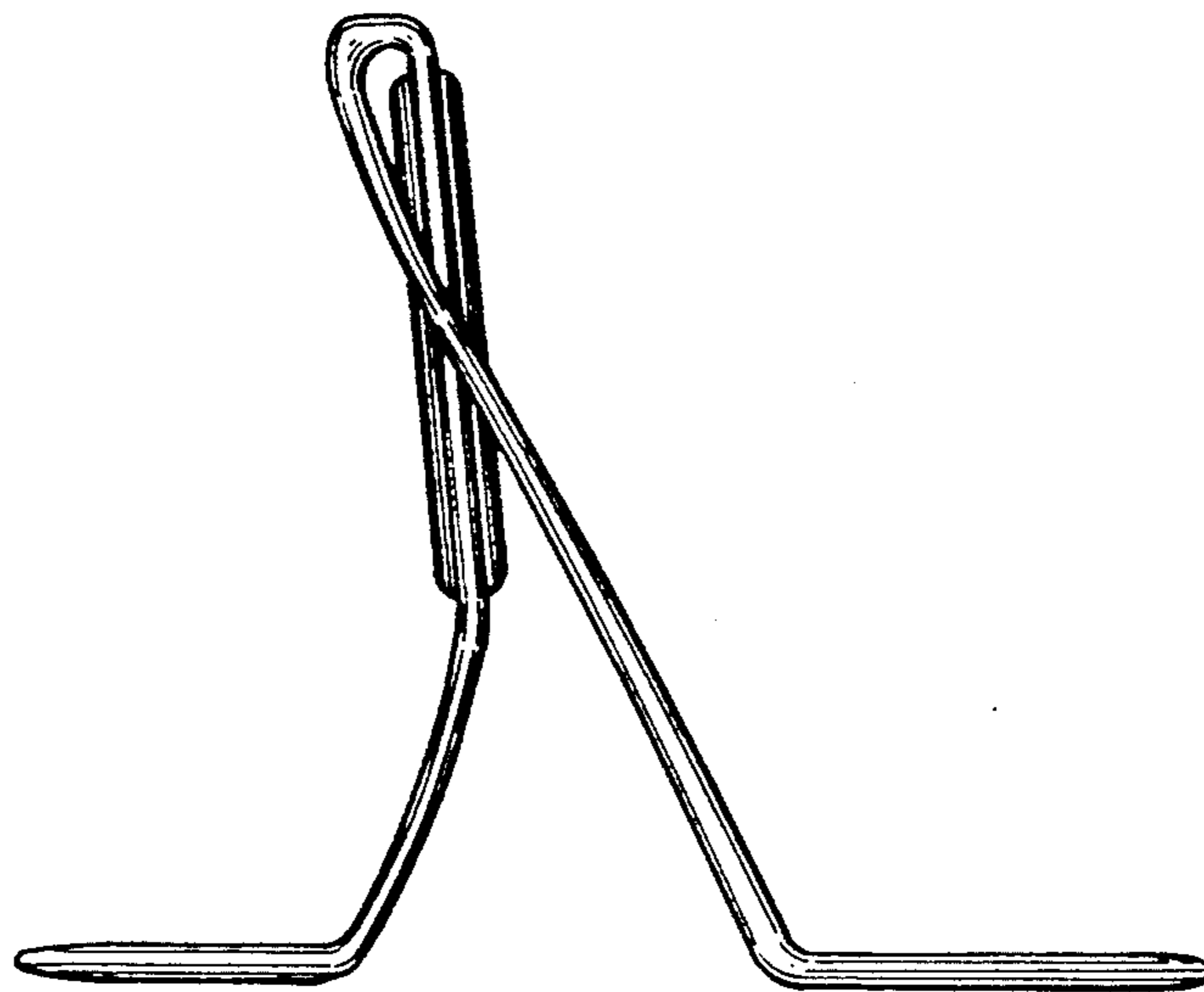

Fig. 3

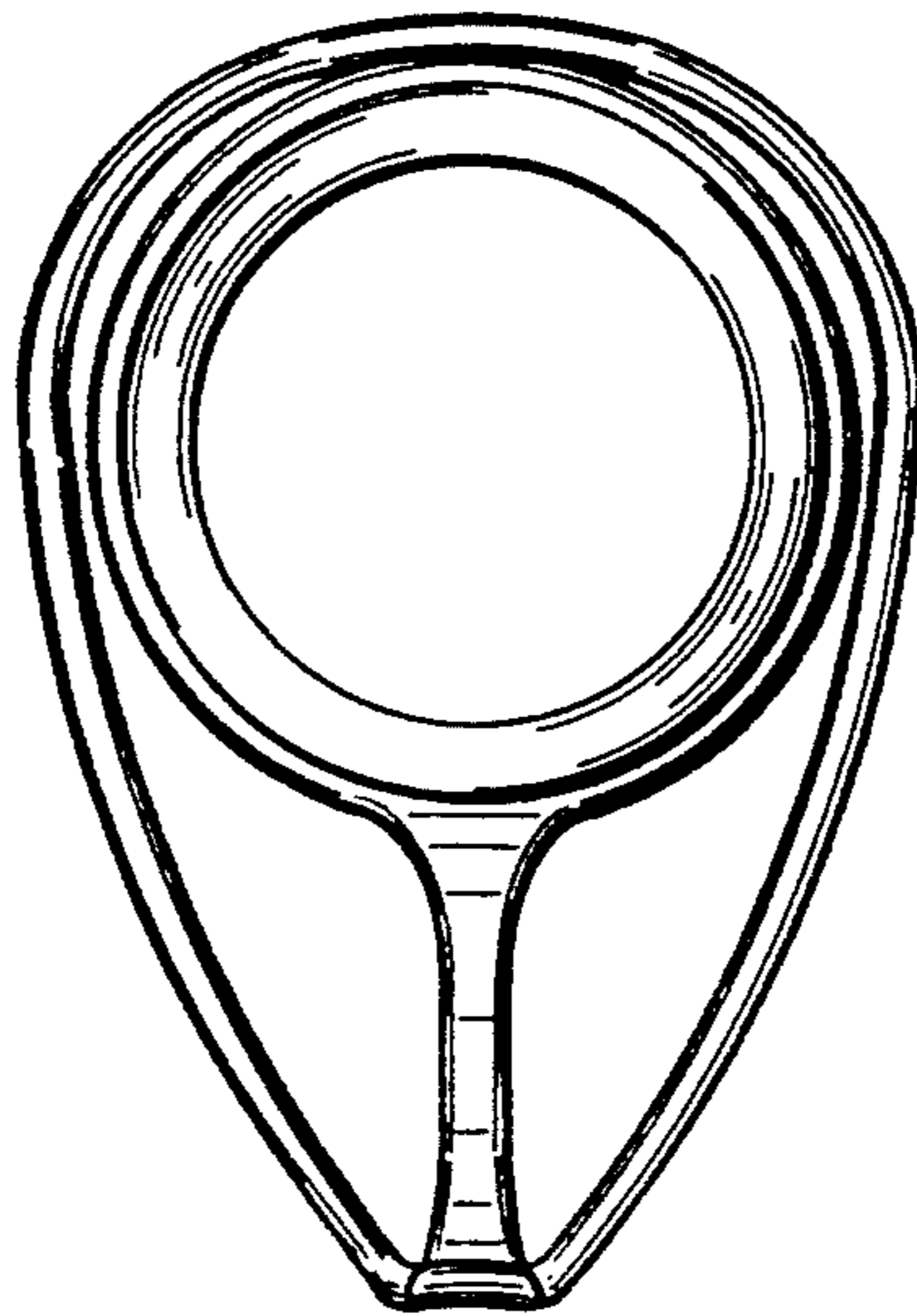

Fig. 4

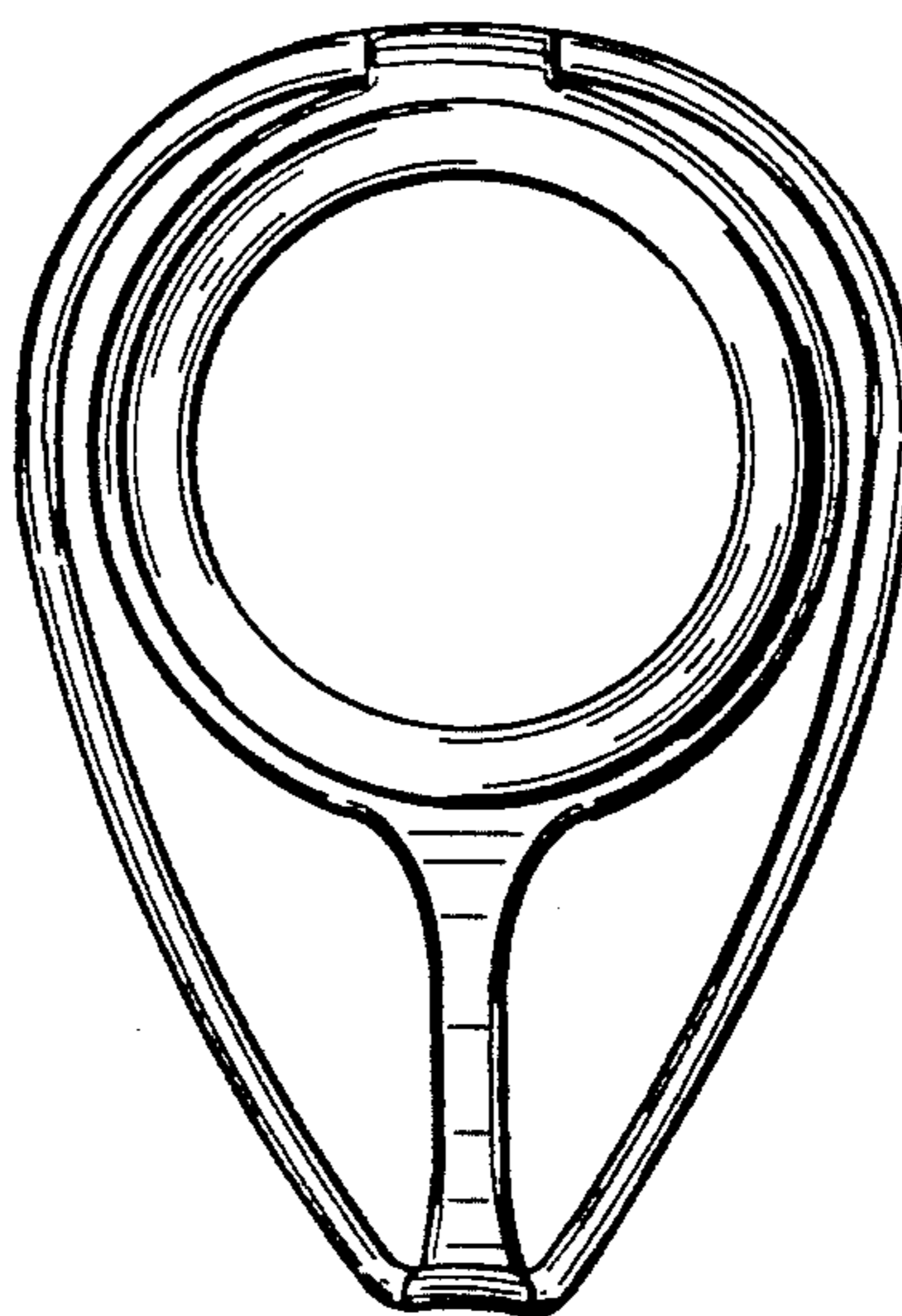

Fig. 5

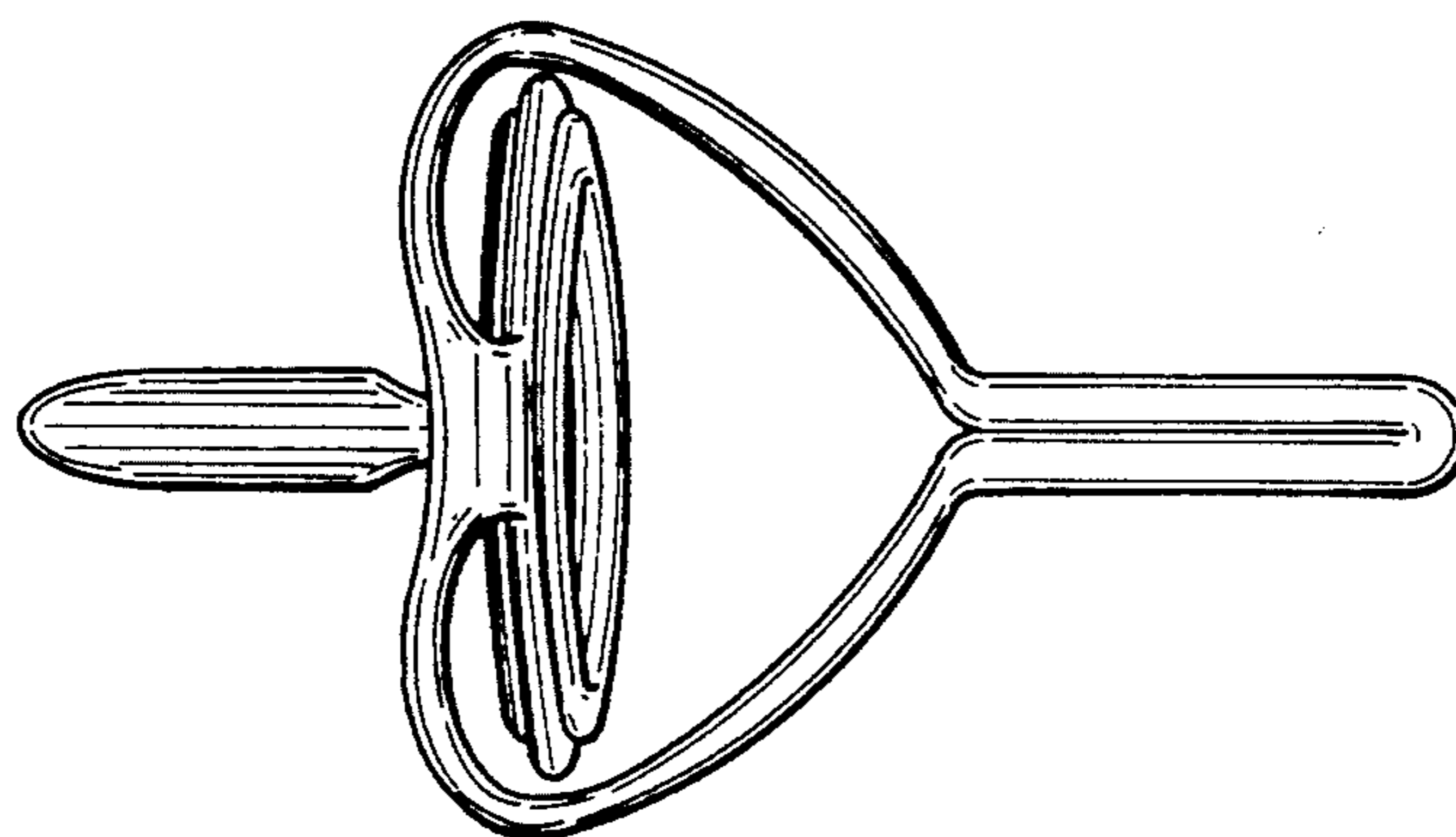

Fig. 6

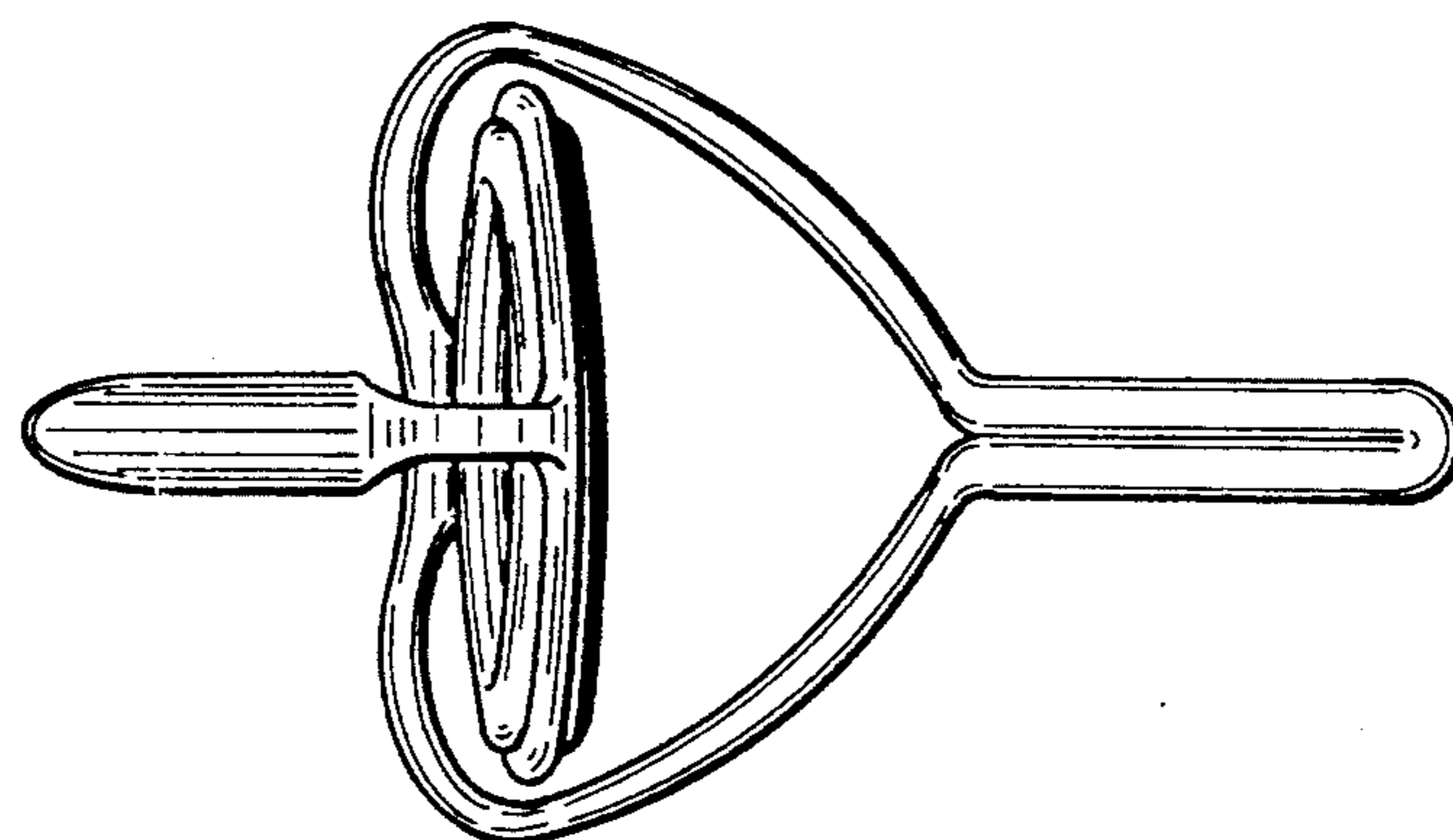

Fig. 7

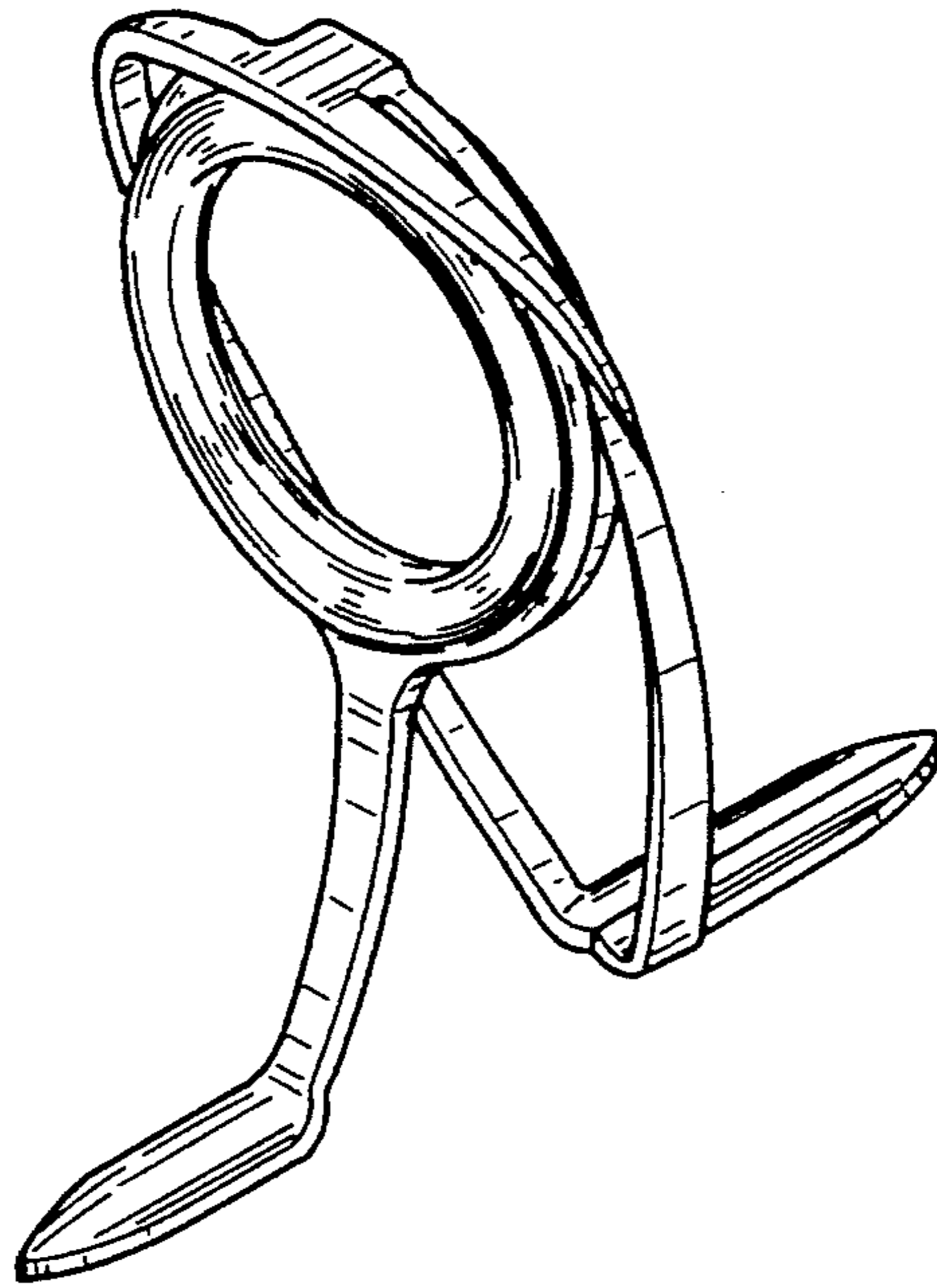

Fig. 8

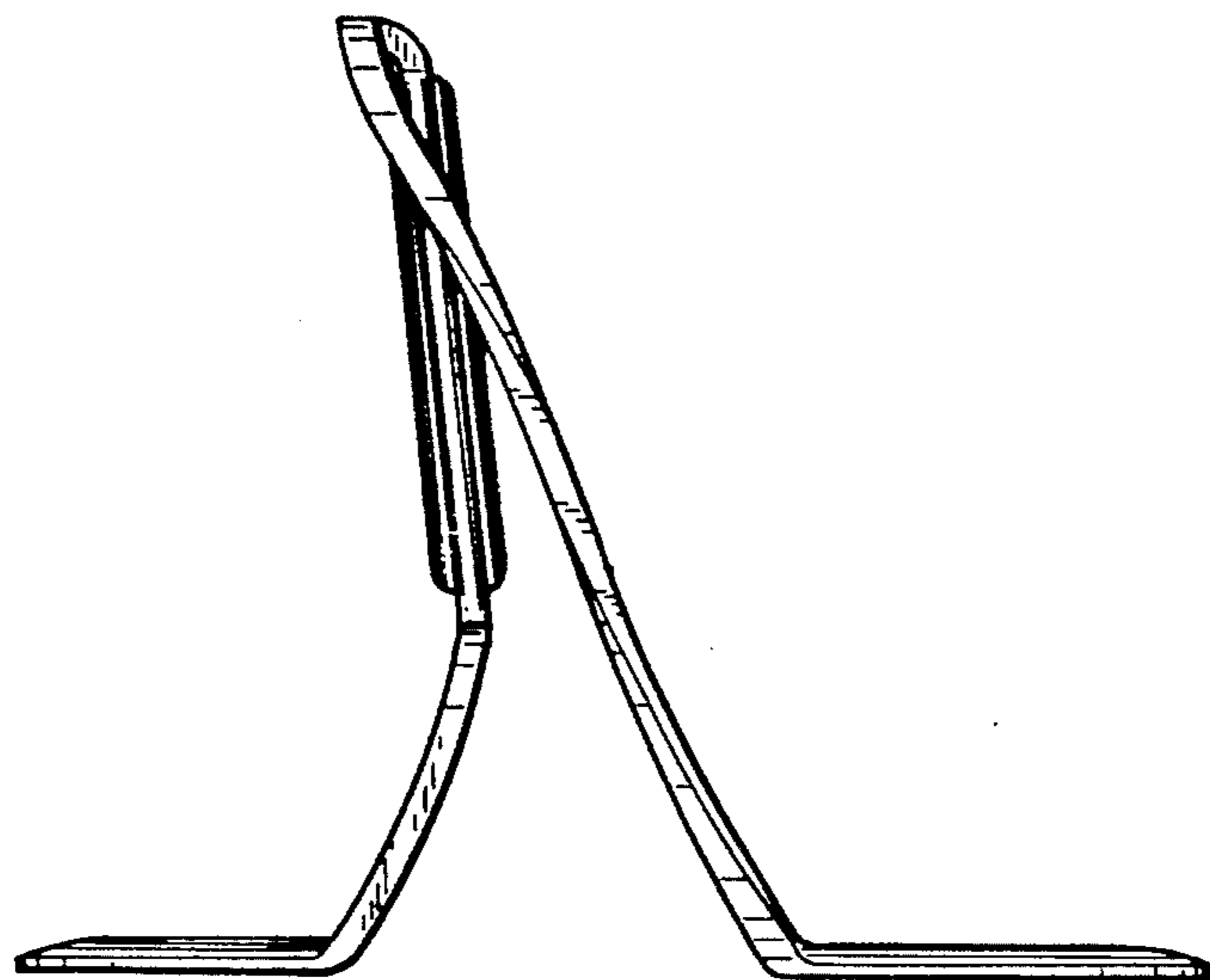

Fig. 9

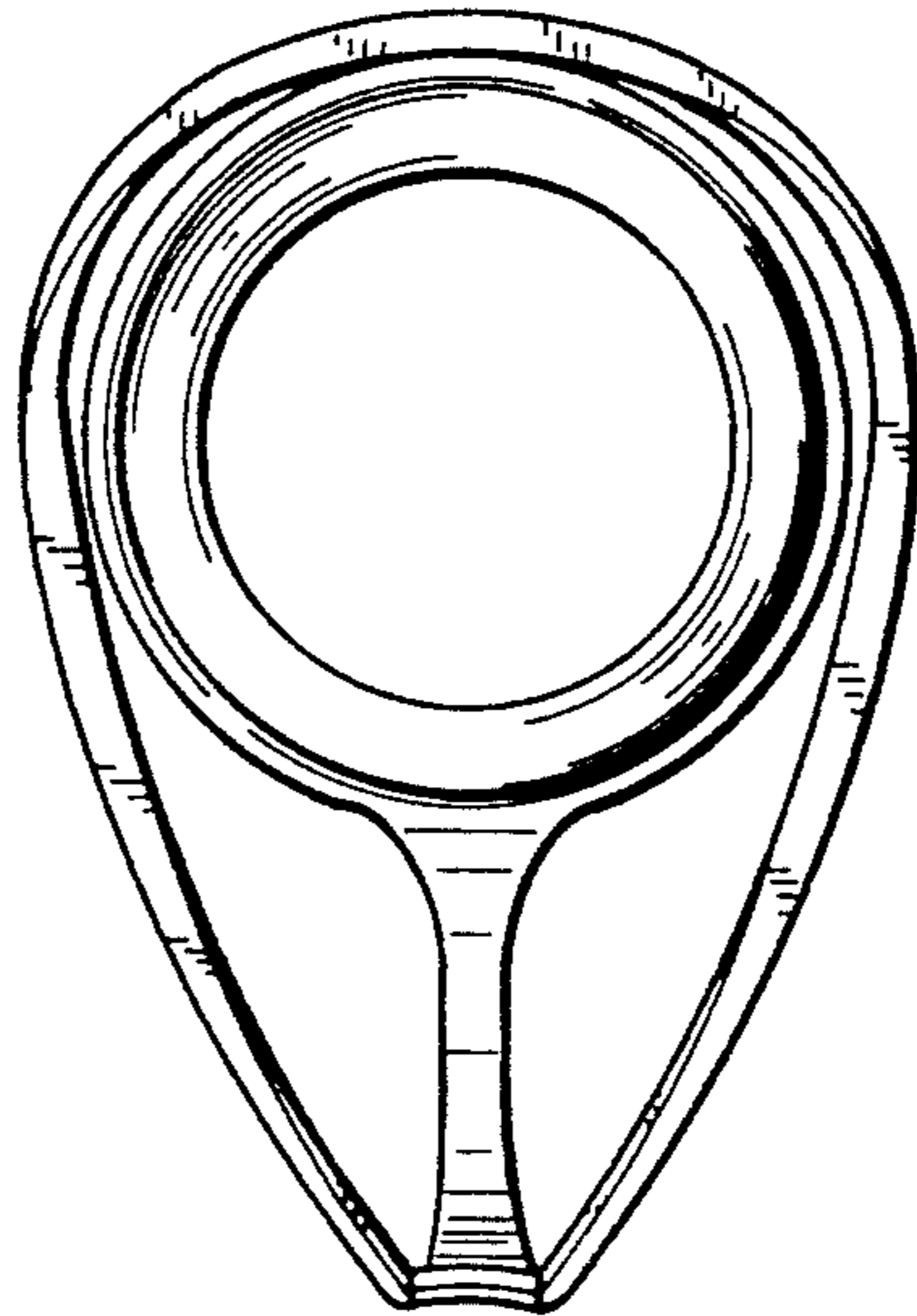

Fig. 10

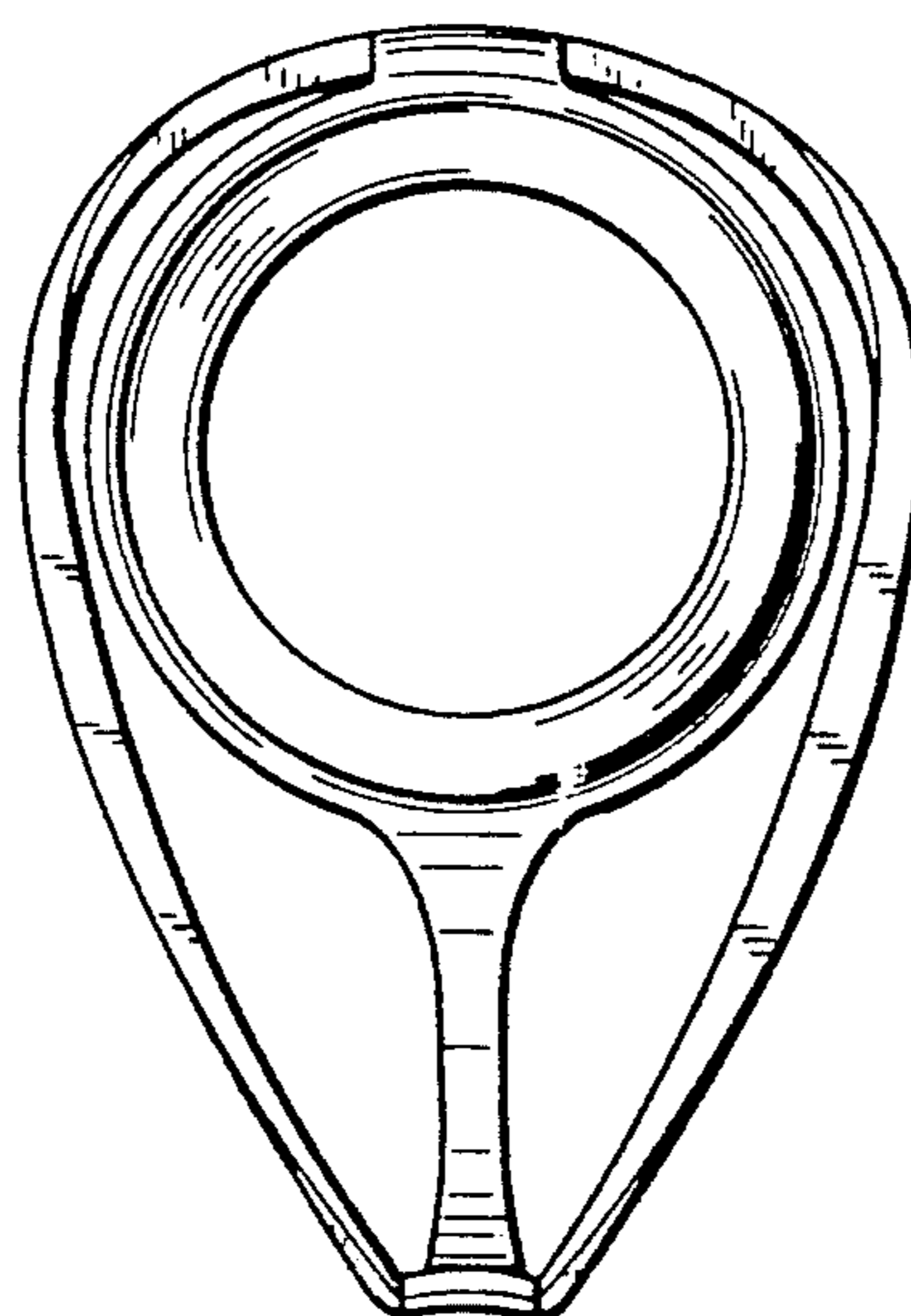

Fig. 11

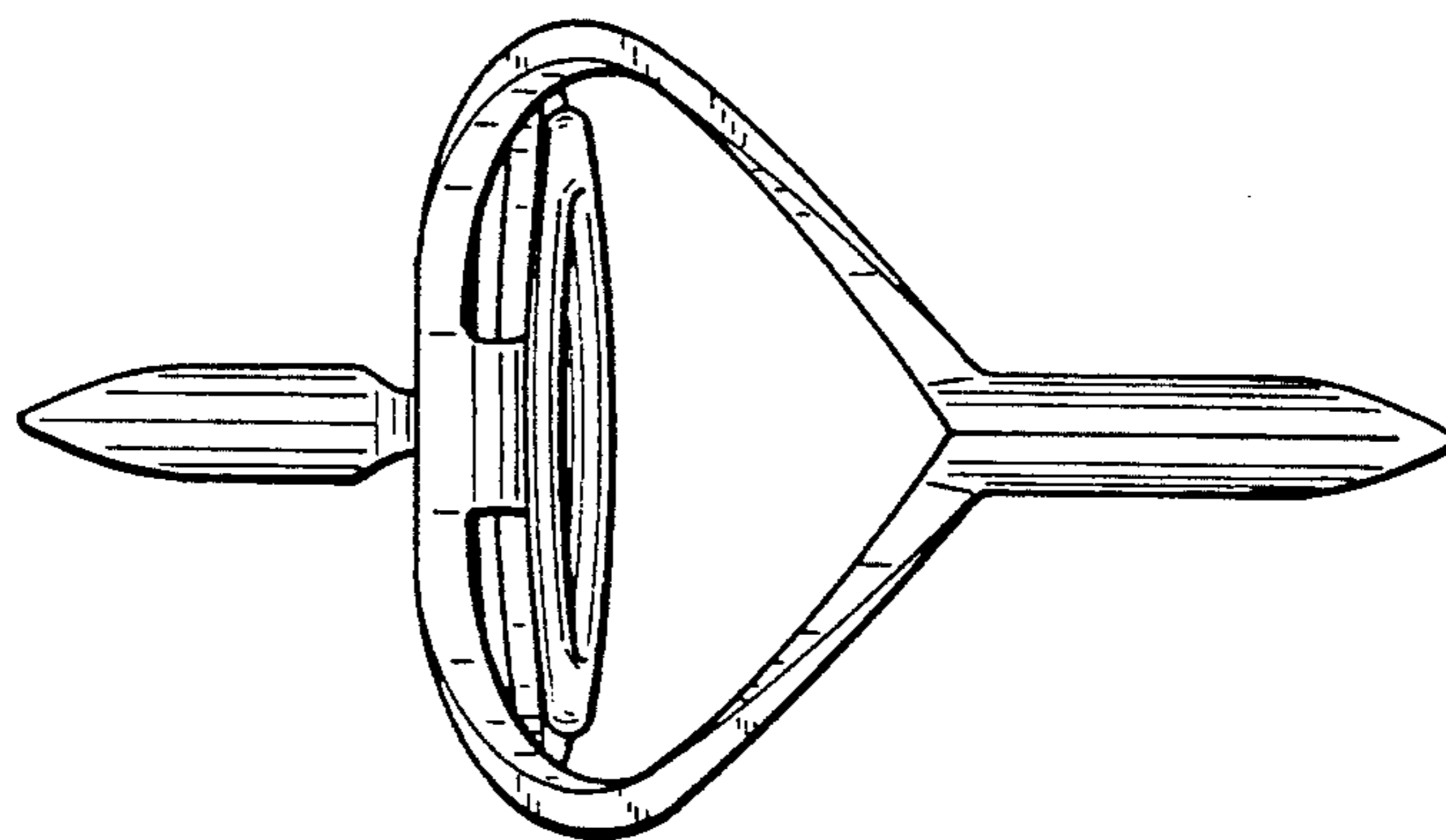

Fig. 12

