



US00D346831S

United States Patent [19]

Adams

[11] Patent Number: Des. 346,831

[45] Date of Patent: ** May 10, 1994

[54] YARD GOLF

4,906,006 3/1990 Sigonick 273/178 R

[76] Inventor: Douglas J. Adams, 4525 Binghamton Dr., Mobile, Ala. 33619

OTHER PUBLICATIONS

Design, Jul. 1987, p. 12 as shown.
Packaging, 1963, p. 177, item #557.
New Yorker, Dec. 1951, p. 31, shown by arrow.

[**] Term: 14 Years

Primary Examiner—Prabhakar G. Deshmukh
Attorney, Agent, or Firm—Hugh E. Smith

[21] Appl. No.: 885,274

[22] Filed: May 18, 1992

[52] U.S. Cl. D21/8; D21/234

[58] Field of Search 273/178 A, 178 R, 178 B,
273/177 R, 34 R, 181 R, 34 A, 32 R, 176 R, 176
A, 176 AA, 179 R, 180; D21/8, 234

[57] CLAIM

The ornamental design for a yard golf, as shown and described.

[56] References Cited

DESCRIPTION

U.S. PATENT DOCUMENTS

D. 242,370	11/1976	Arndt et al.	D21/234
D. 257,785	1/1981	Arndt et al.	D21/234
D. 264,114	4/1982	Wojciechowski	D21/234
1,287,903	12/1918	Daily	273/178 R
3,059,931	10/1962	Garcia	273/179 C
3,752,482	8/1973	Cassel	273/178 R X
4,878,671	11/1989	Gubany	273/176 R

FIG. 1 is a front elevational view of the yard golf showing my new design;
FIG. 2 is a rear elevational view thereof;
FIG. 3 is a left side elevational view thereof;
FIG. 4 is a right side elevational view thereof;
FIG. 5 is a top plan view thereof;
FIG. 6 is a bottom plan view thereof; and,
FIG. 7 is an isometric view thereof.

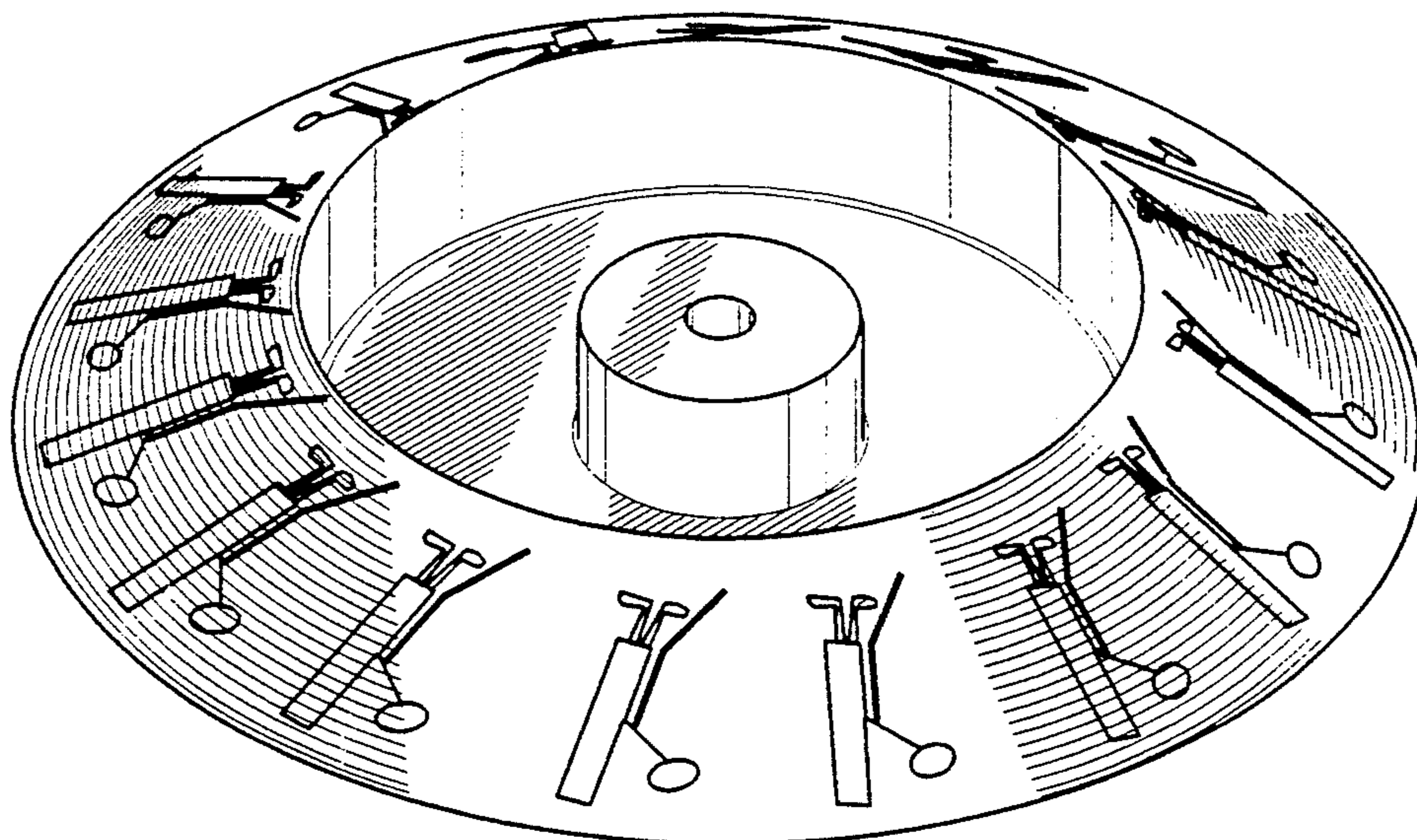

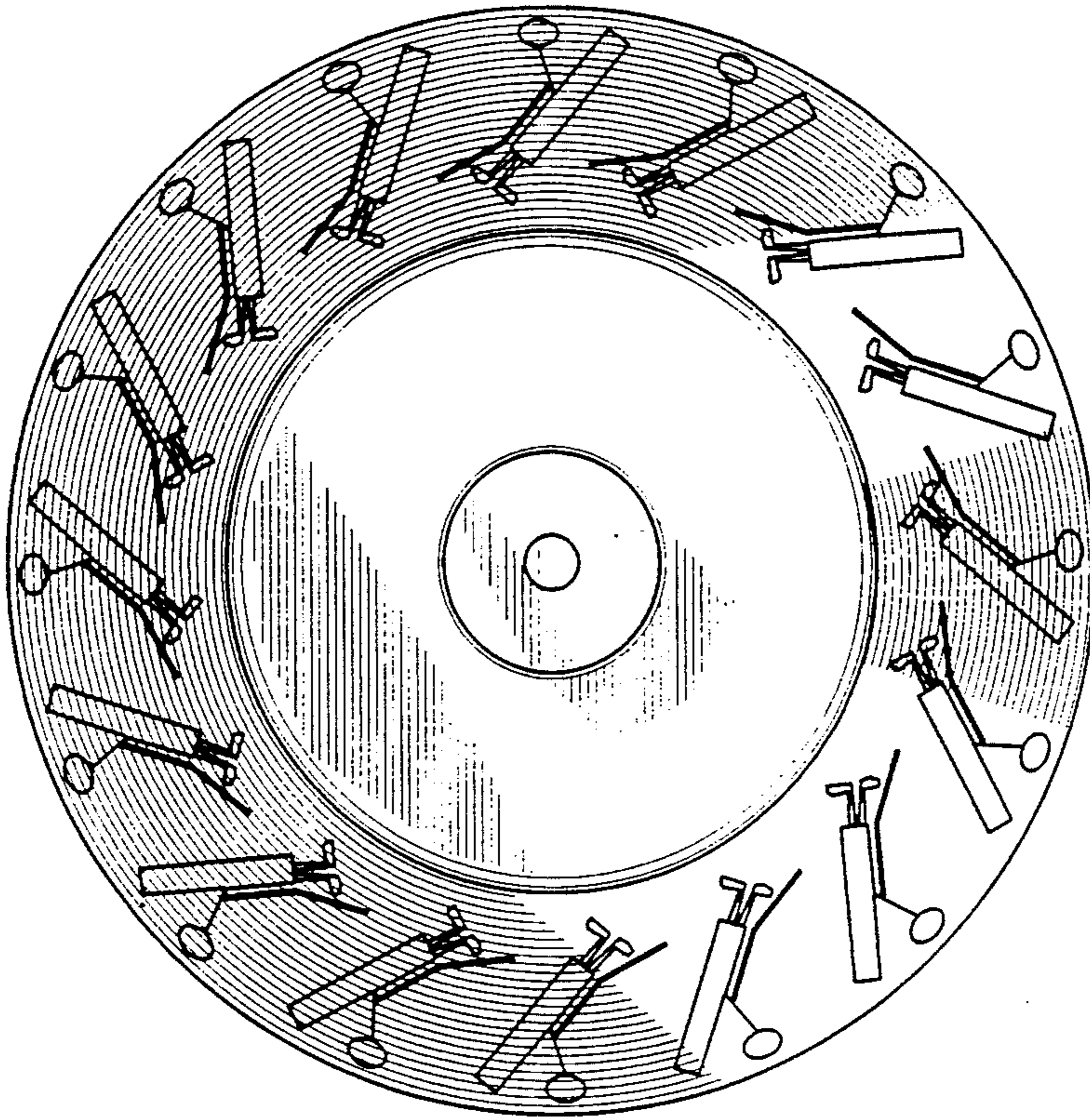

FIG. 1

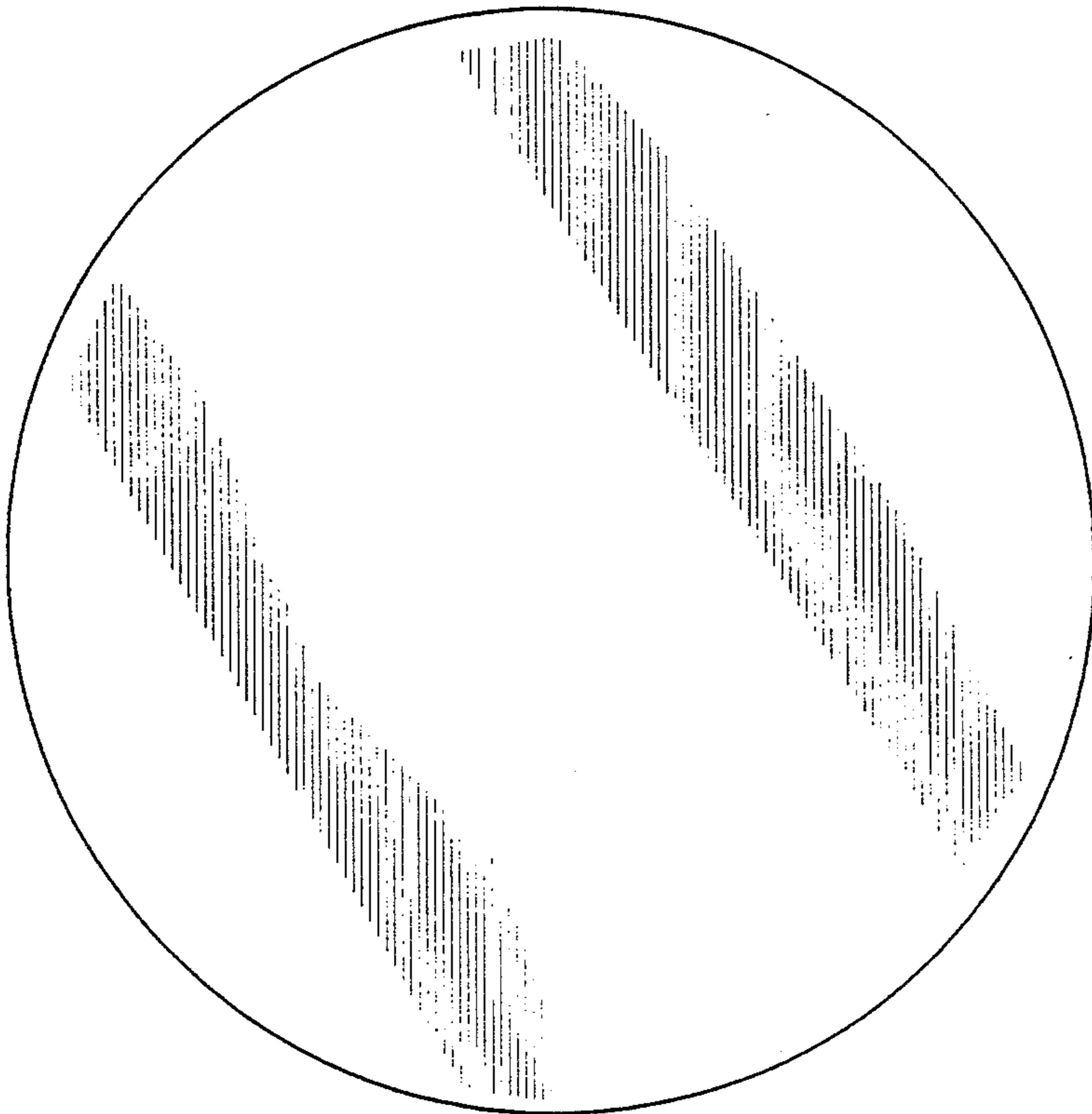

FIG. 2

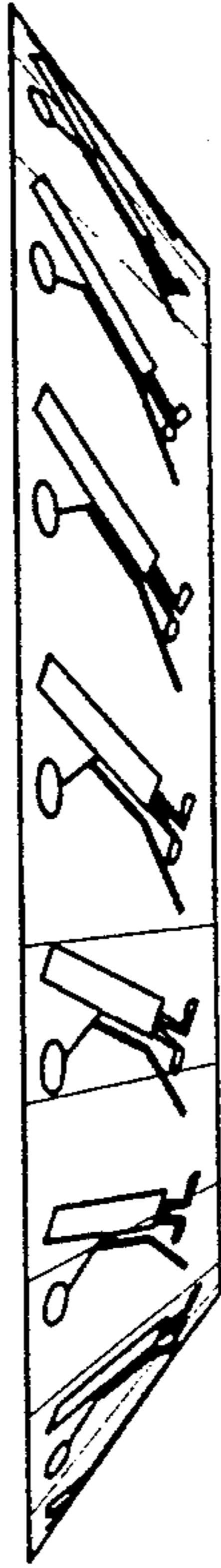

FIG. 3

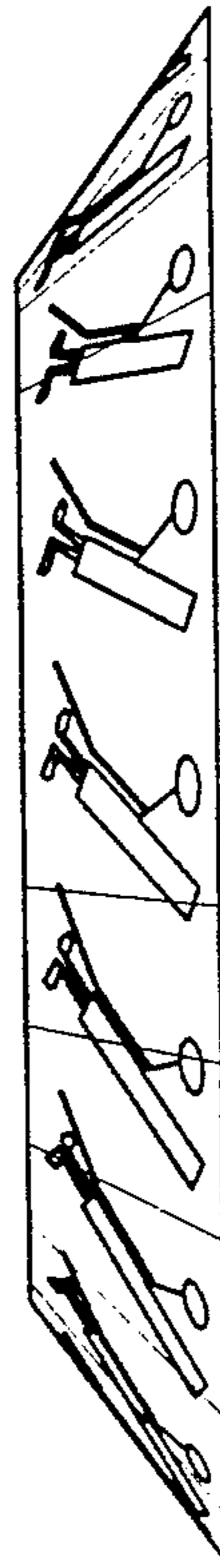

FIG. 4

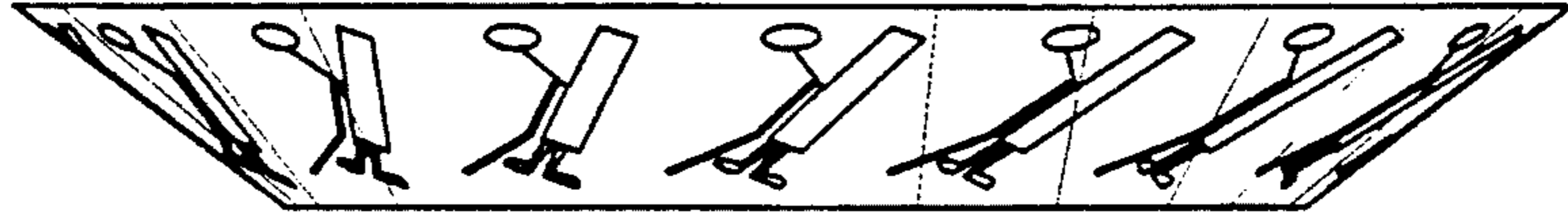

FIG. 5

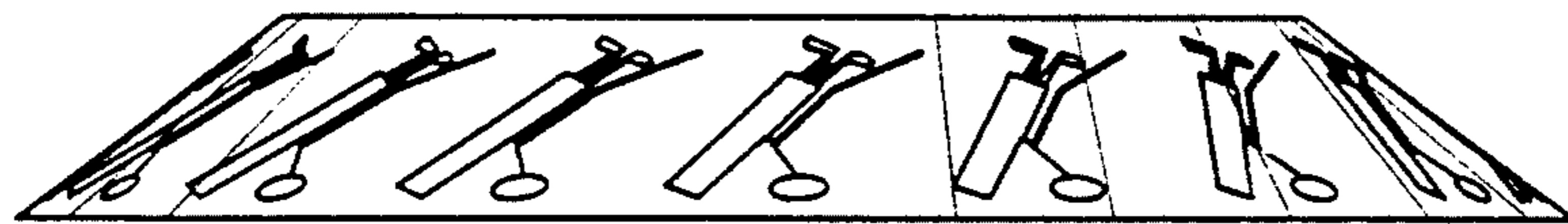

FIG. 6

FIG. 7

