



US00D346767S

United States Patent [19]

[11] Patent Number: **Des. 346,767**

Fujita

[45] Date of Patent: **** May 10, 1994**

[54] GUIDE RAIL FOR AN OVERHEAD MONORAIL

[75] Inventor: **Shigeyoshi Fujita, Osaka, Japan**

[73] Assignee: **Daifuku Co., Ltd., Osaka, Japan**

[**] Term: **14 Years**

[21] Appl. No.: **942,528**

[22] Filed: **Sep. 9, 1992**

[52] U.S. Cl. **D12/50**

[58] Field of Search **164/110, 93; D12/50; D25/74; D34/28, 29**

[56] References Cited

U.S. PATENT DOCUMENTS

D. 32,406	3/1900	Hagard	D12/50
D. 191,601	10/1961	Scott	D12/50
D. 289,983	5/1987	Mino et al.	D12/50
4,733,615	3/1988	Volkstorf et al.	104/110

FOREIGN PATENT DOCUMENTS

3338841 5/1985 Fed. Rep. of Germany 104/110

Primary Examiner—James M. Gandy

Assistant Examiner—M. Brown

Attorney, Agent, or Firm—Schweitzer Cornman & Gross

[57] CLAIM

The ornamental design for a guide rail for an overhead monorail, as shown.

DESCRIPTION

FIG. 1 is a top plan view of a guide rail for an overhead monorail showing my new design;
 FIG. 2 is a front elevational view thereof;
 FIG. 3 is a bottom plan view thereof;
 FIG. 4 is a rear elevational view thereof;
 FIG. 5 is a right end elevational view thereof, the left end being a mirror image of that shown;
 FIG. 6 is a cross sectional view thereof taken along line 6—6 in FIG. 2; and,
 FIG. 7 is a perspective view thereof.

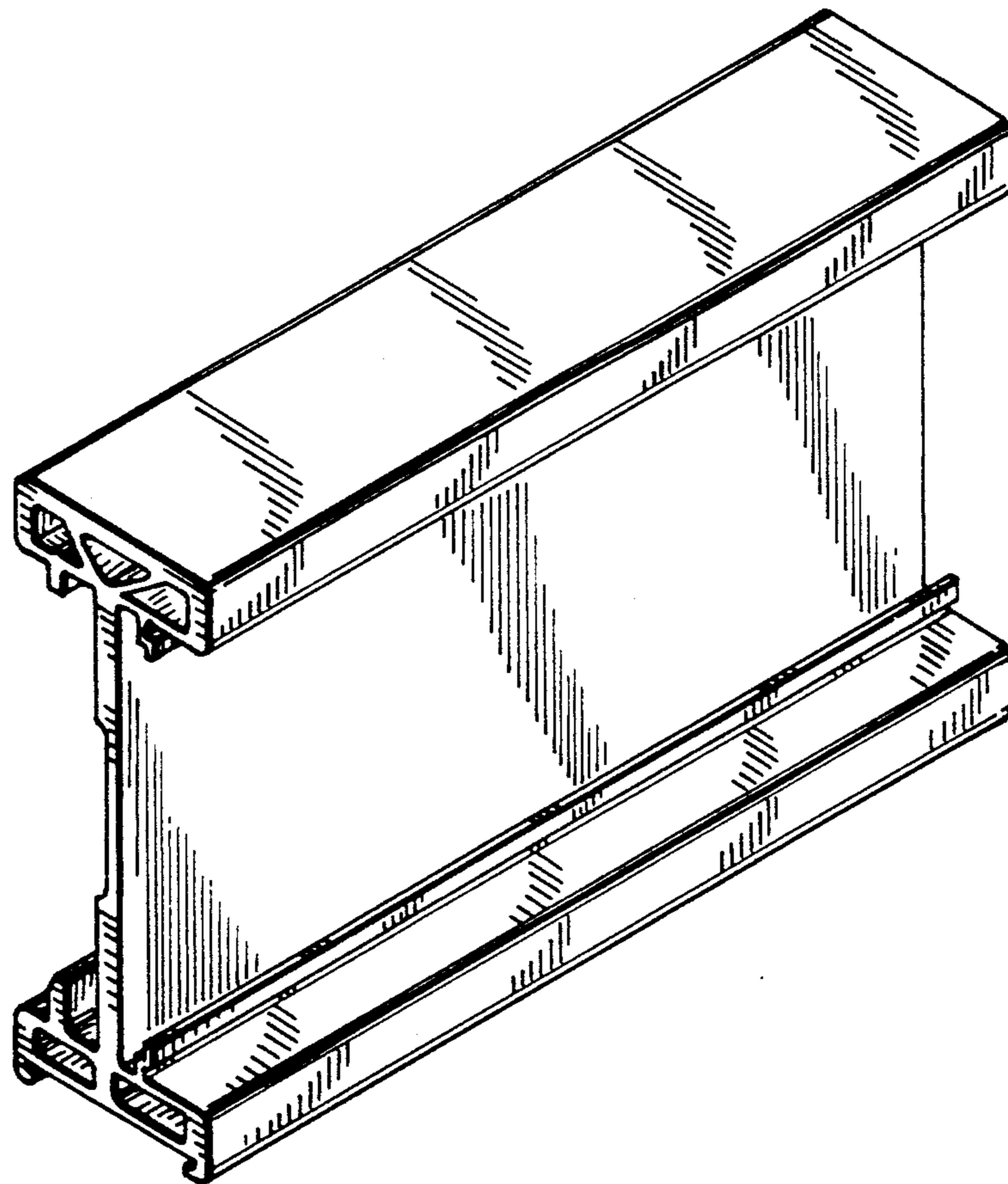
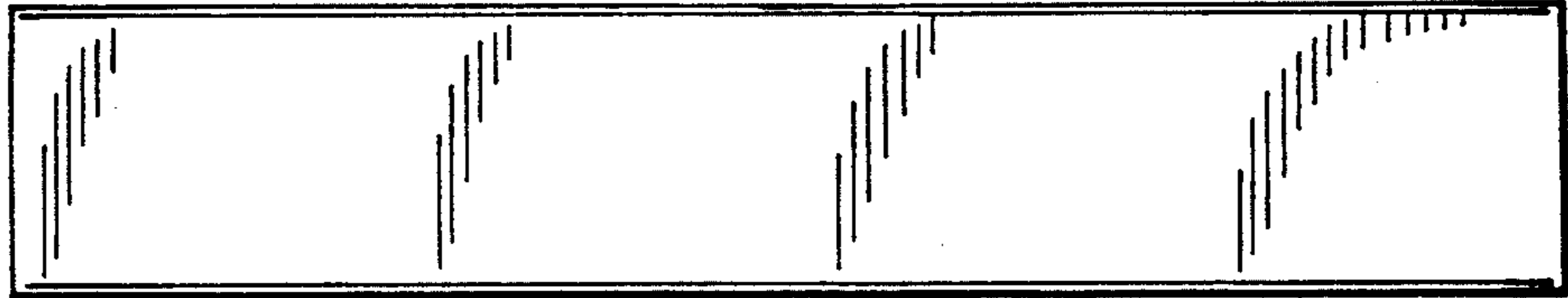
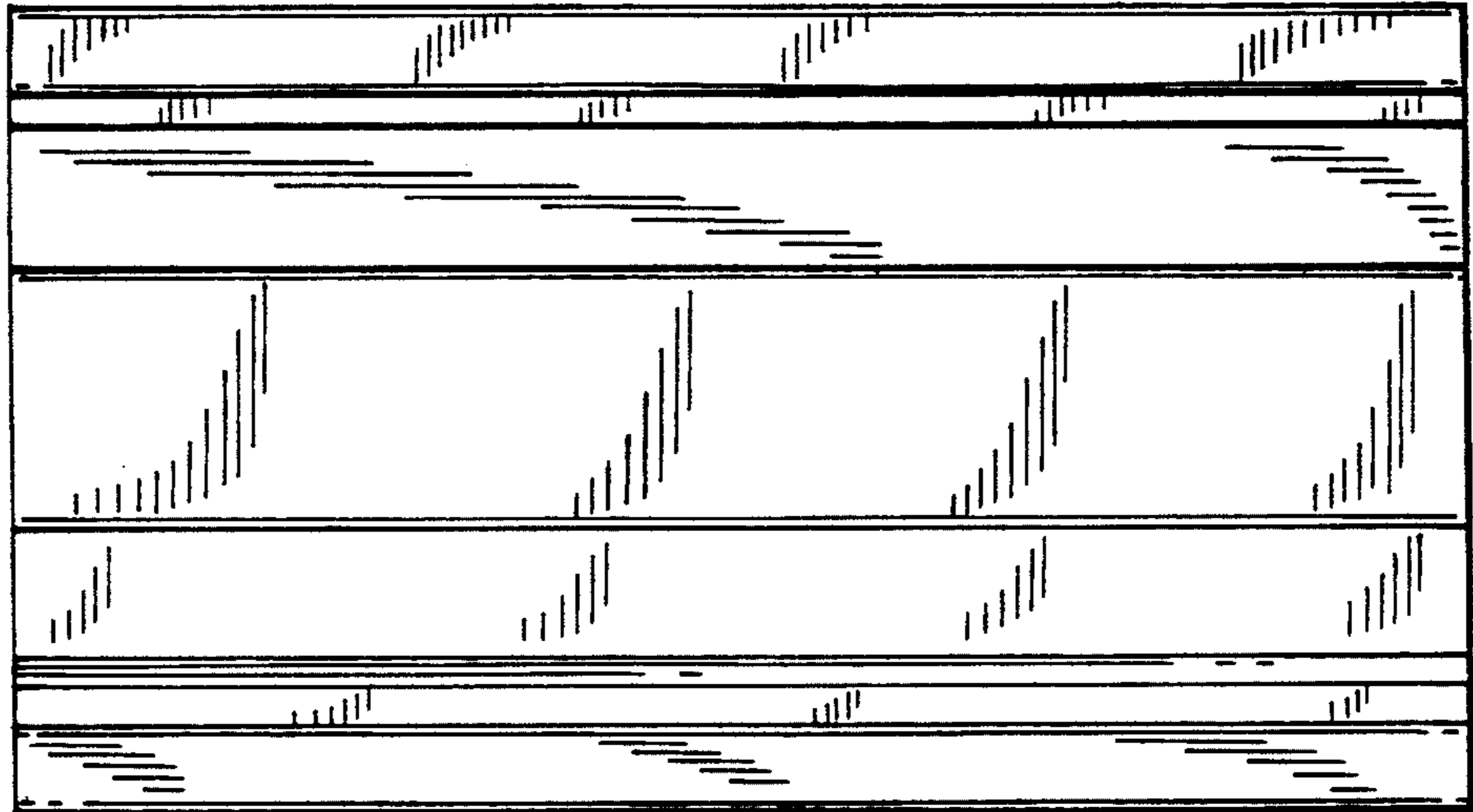

FIG. 1



6 ↗

FIG. 2



6 ↗

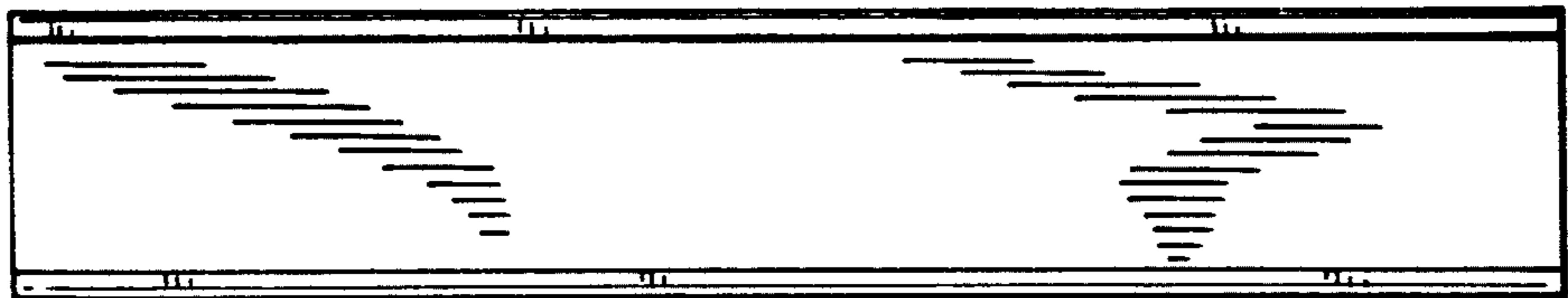

FIG. 3

FIG. 4

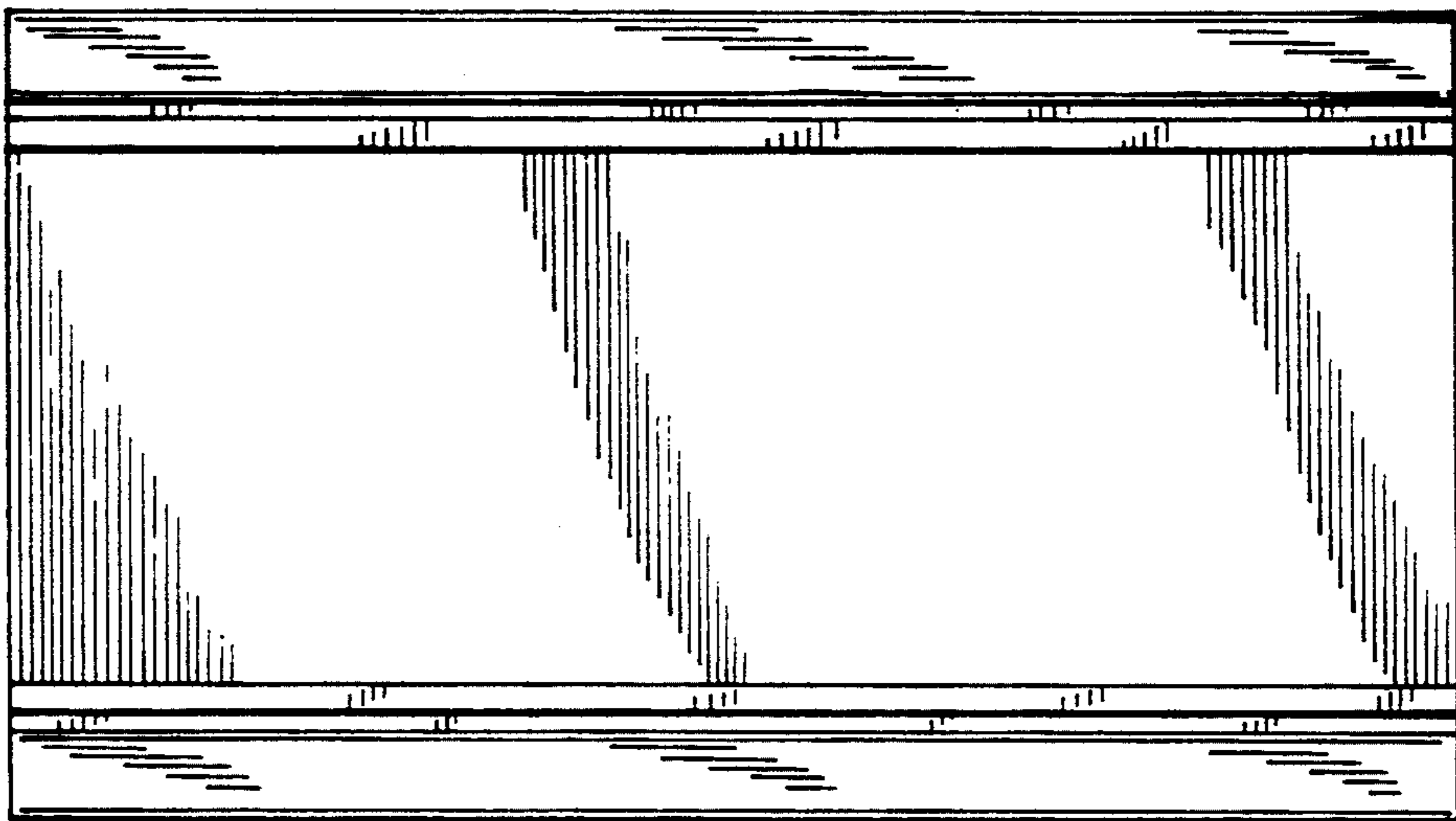

FIG. 5

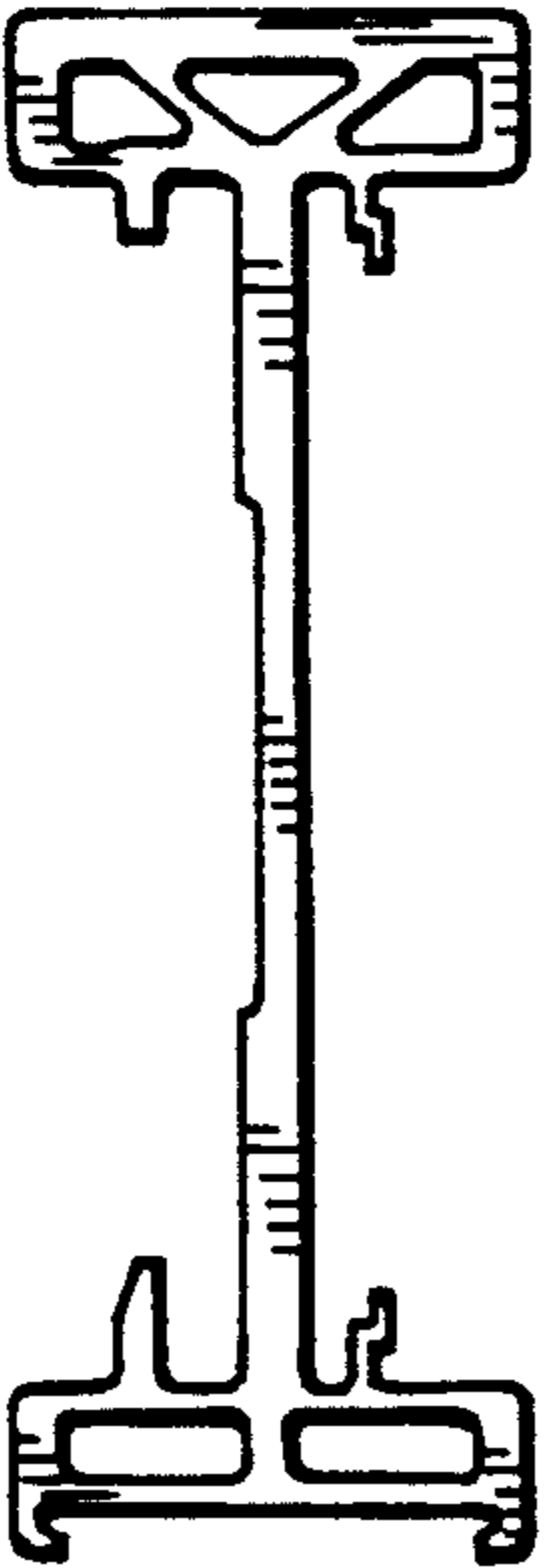

FIG. 6

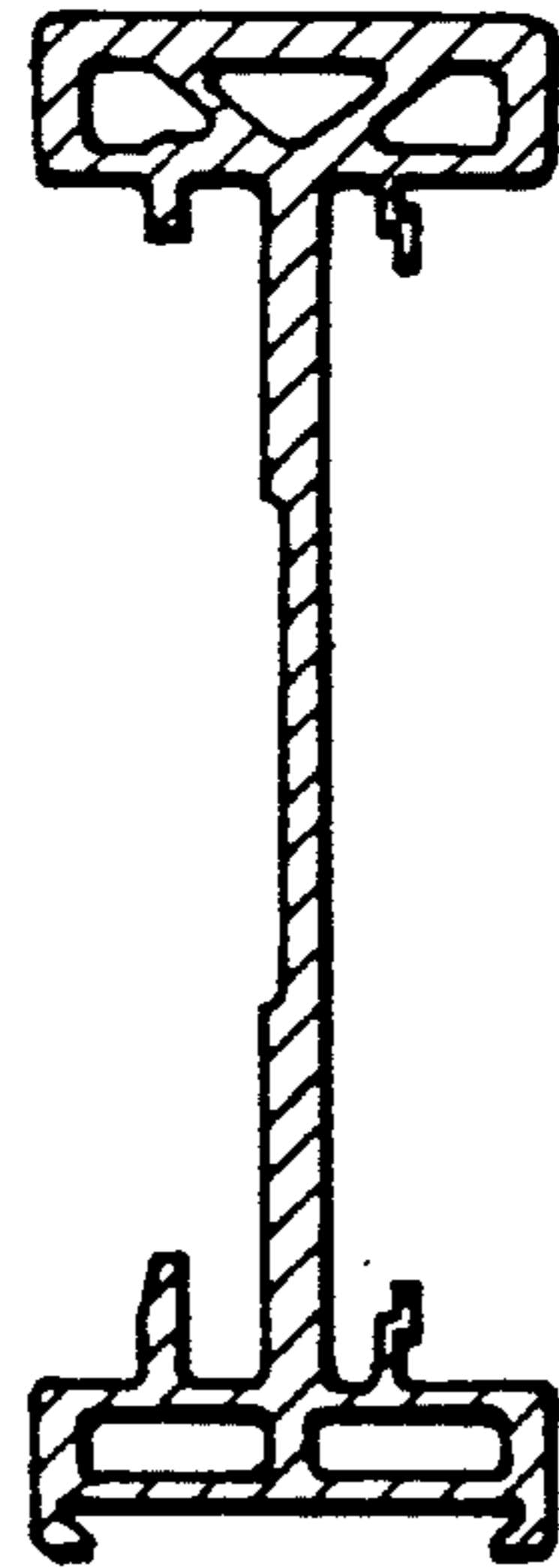

FIG. 7

