



US00D346716S

United States Patent [19]
Murphy

[11] **Patent Number: Des. 346,716**
[45] **Date of Patent: ** May 10, 1994**

- [54] **BEACH PAD WITH INSERT**
- [76] **Inventor: William Murphy, 10485 La Vita Ct., San Diego, Calif. 92131**
- [**] **Term: 14 Years**
- [21] **Appl. No.: 511,010**
- [22] **Filed: Apr. 19, 1990**
- [52] **U.S. Cl. D6/596; D6/595**
- [58] **Field of Search D6/596, 604, 595, 601-603; 2/69, 69.5; D2/25; 5/420, 417, 419, 482; D5/26, 14; D21/237**

Primary Examiner—Wallace R. Burke
Assistant Examiner—Lisa Lichtenstein
Attorney, Agent, or Firm—Terry M. Gernstein

[57] **CLAIM**

The ornamental design for a beach pad with insert, as shown and described.

DESCRIPTION

FIG. 1 is a top, right side and left end perspective view of a beach pad with insert showing my new design; FIG. 2 is a left end elevational view thereof; FIG. 3 is a right end elevational view thereof; FIG. 4 is a right side elevational view thereof, the left side being a mirror image of that shown except for the insert; FIG. 5 is a bottom plan view thereof; FIG. 6 is an enlarged top, right end and left side perspective view of the insert portion of a beach pad with insert shown separately for clarity of illustration; FIG. 7 is a left side elevational view of FIG. 6, the right side being a mirror image of that shown; FIG. 8 is a right end elevational view of FIG. 6, the left end being a mirror image of that shown; FIG. 9 is a bottom plan view of FIG. 6; FIG. 10 is a top plan view of FIG. 1; and, FIG. 11 is a top plan view thereof in an unexploded position.

[56] **References Cited**
U.S. PATENT DOCUMENTS

D. 138,249	7/1944	Burton	D5/14
D. 181,679	12/1957	Scheiding	D5/26
D. 209,730	12/1967	Shapiro	D6/597
D. 309,169	7/1990	Scheurer	D21/237
D. 321,760	11/1991	Carney	D24/190
3,595,223	7/1971	Castagna	5/457
5,005,237	4/1991	Hutchinson	5/482

OTHER PUBLICATIONS

Flags of Maritime Nations ©1914, p. 56, Anchor Symbol A top left side of page.
American Badges & Insignia—Kerrigan, ©1967, p. 167, Symbol 80, top right side of page.

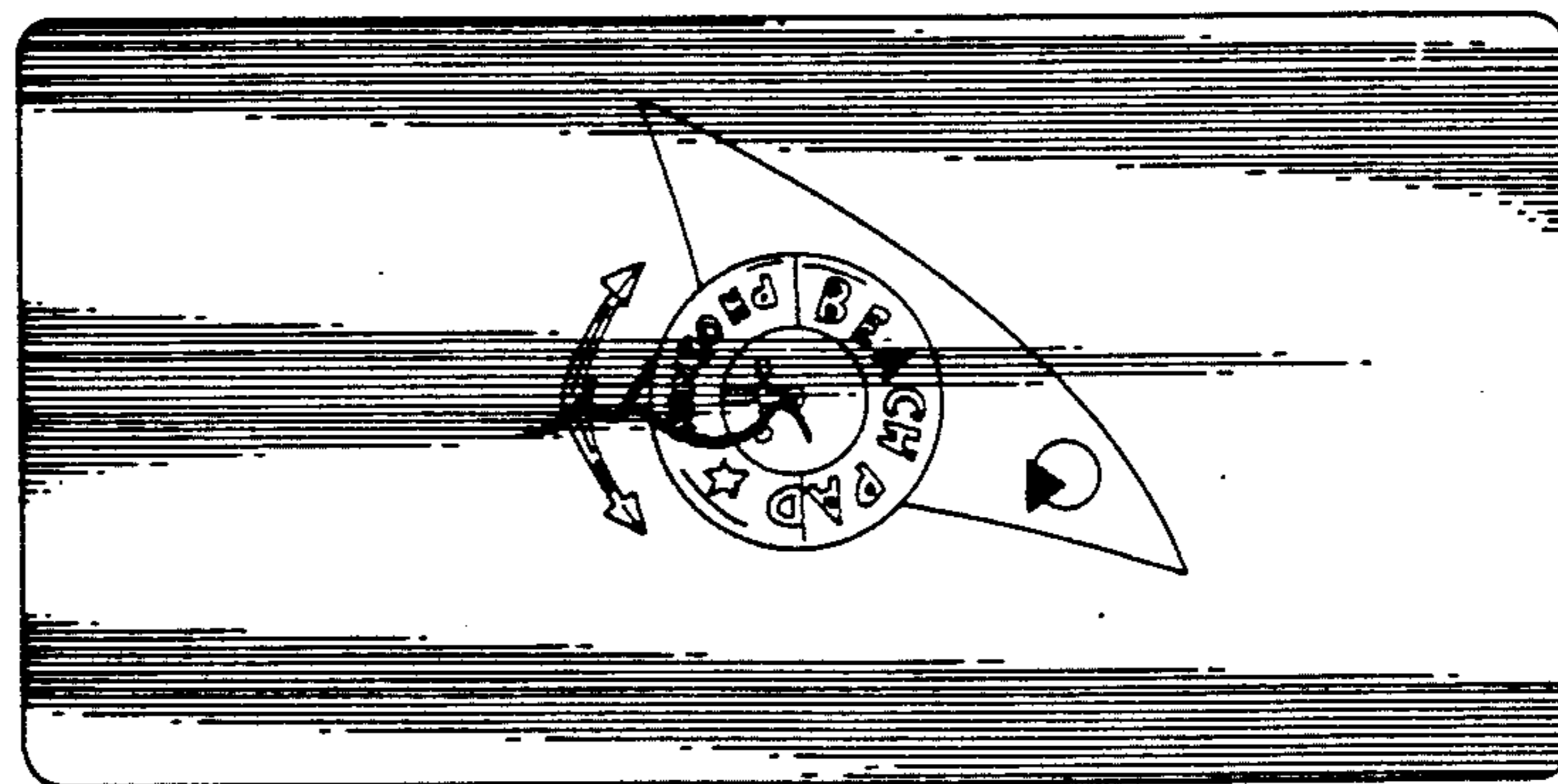
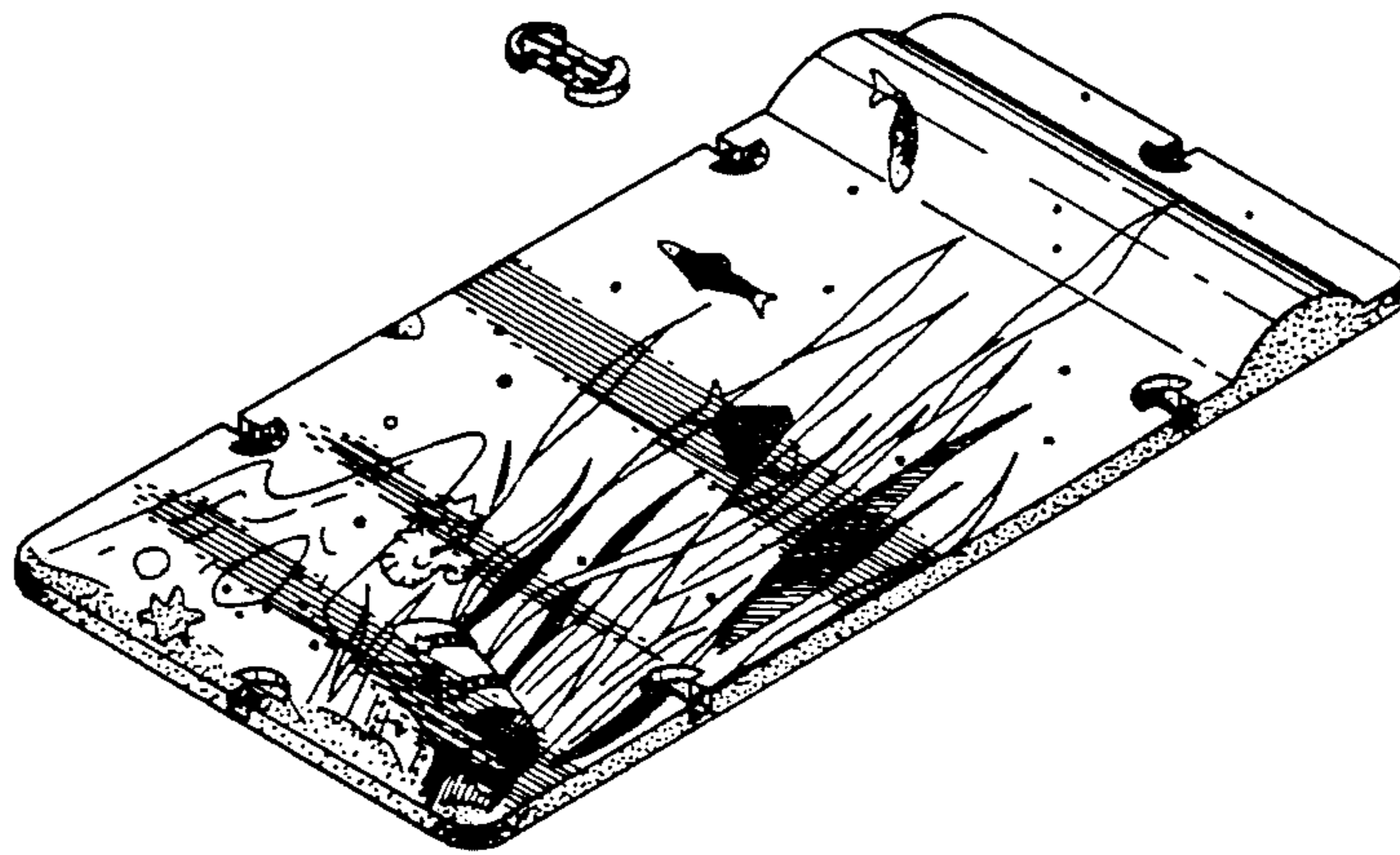

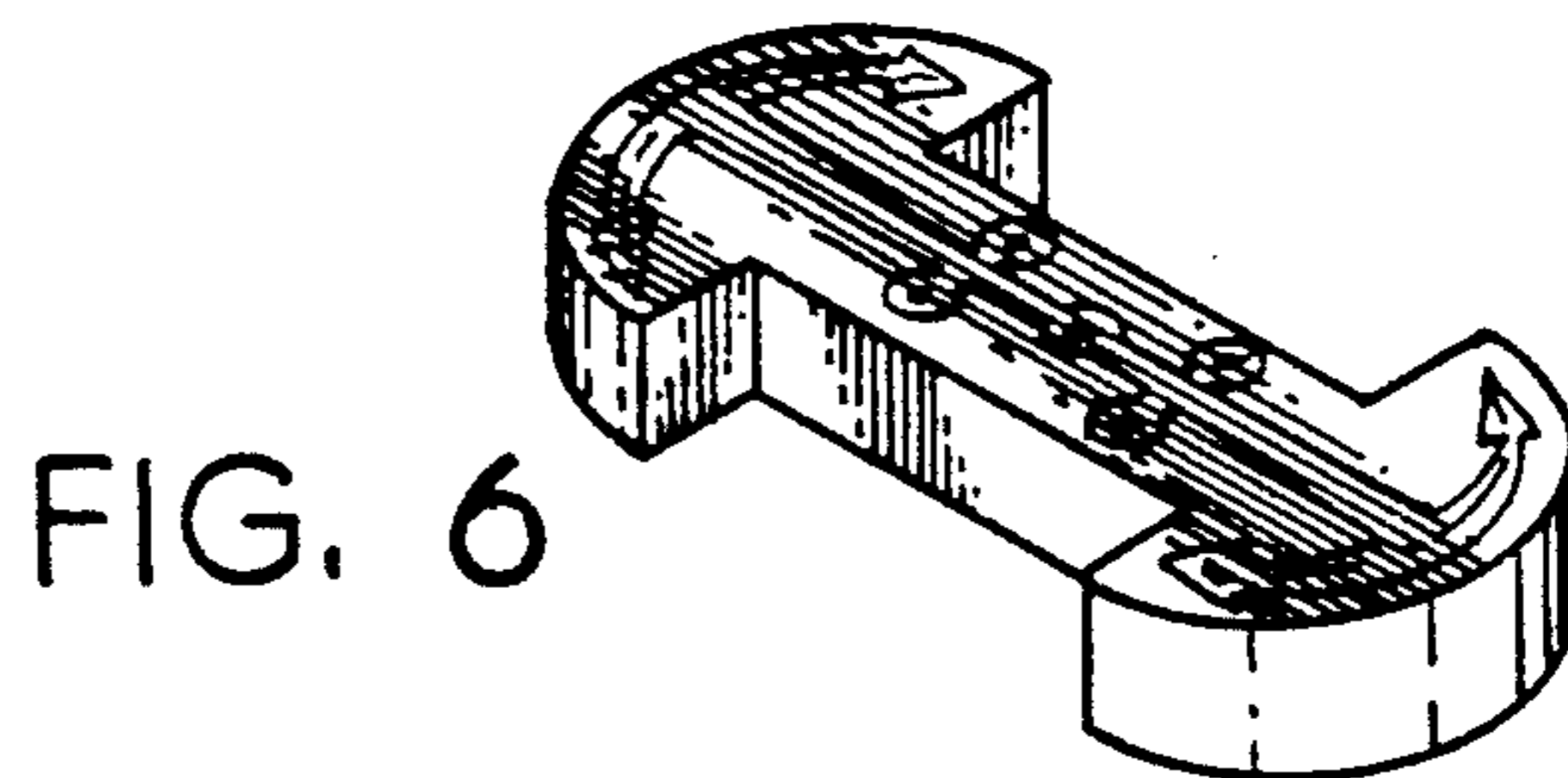
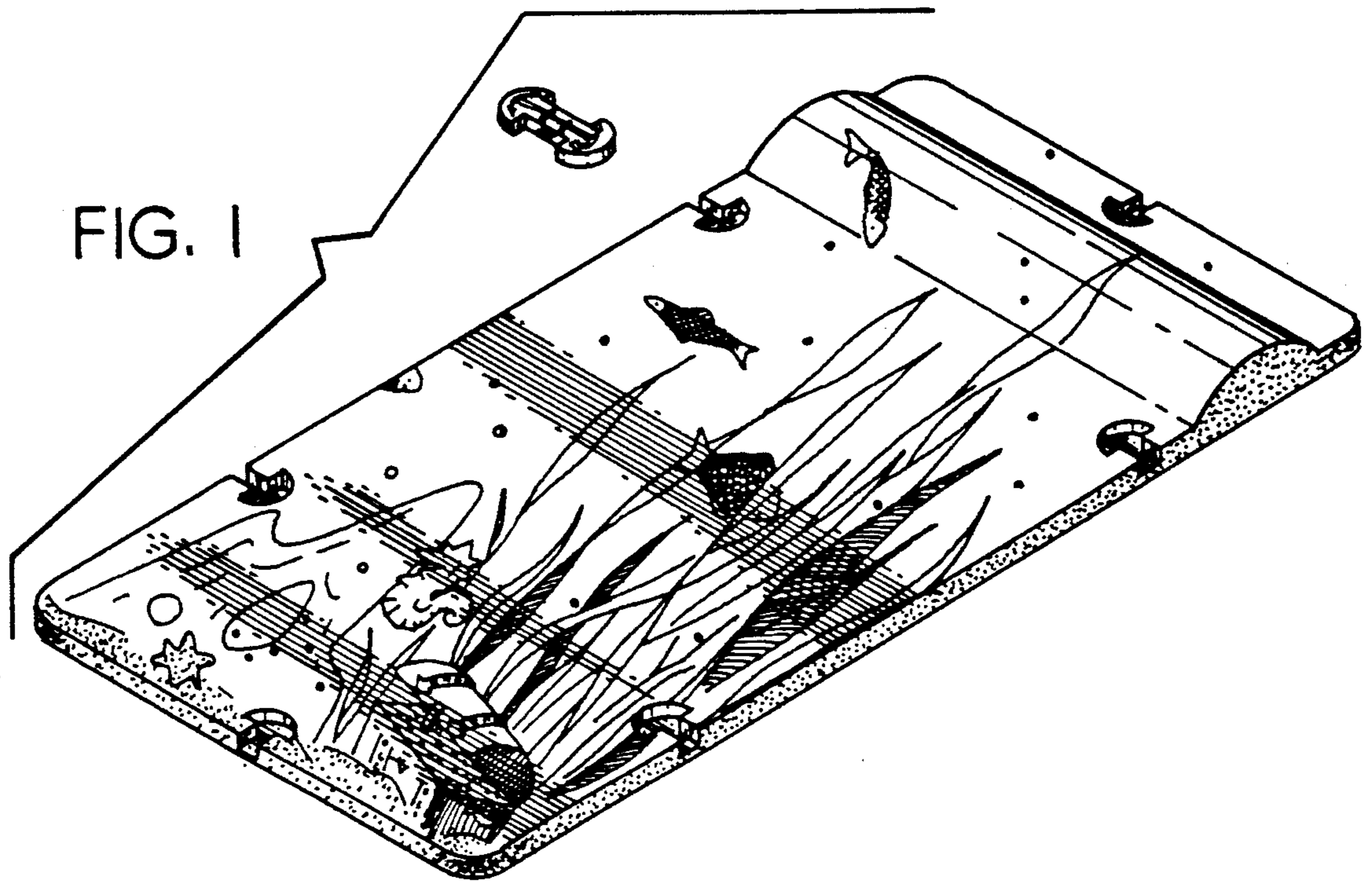

FIG. 4

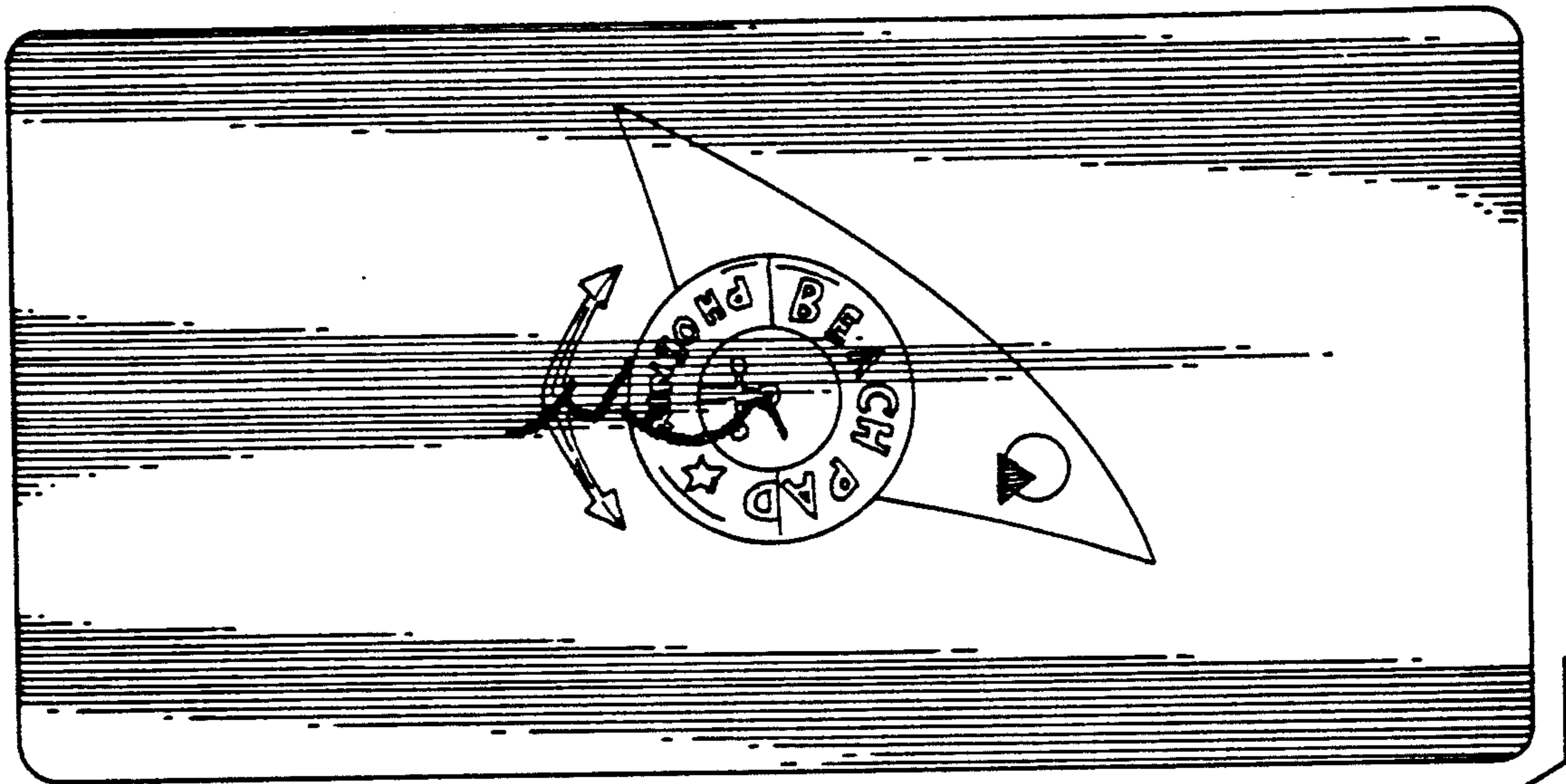

FIG. 2



FIG. 5

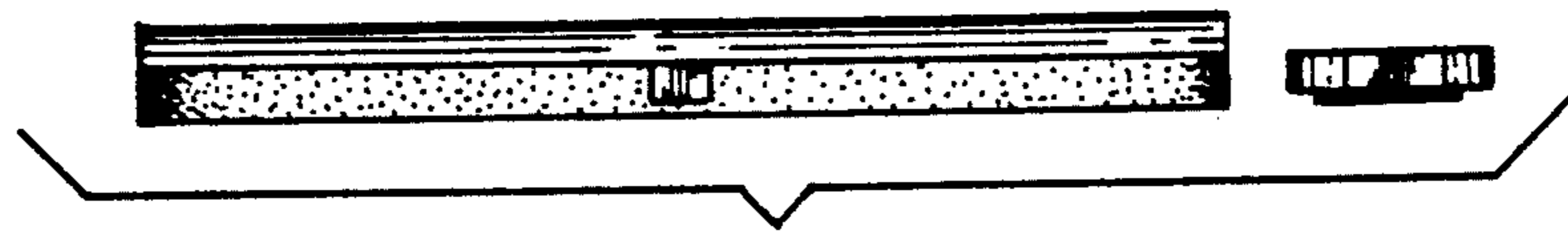
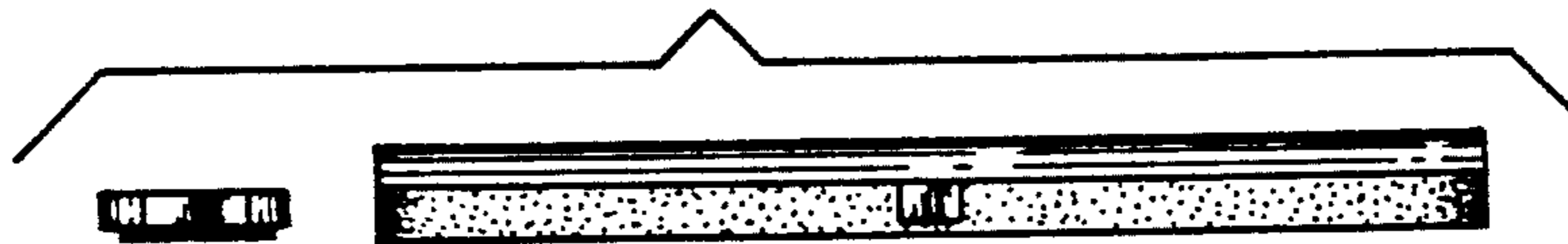

FIG. 3

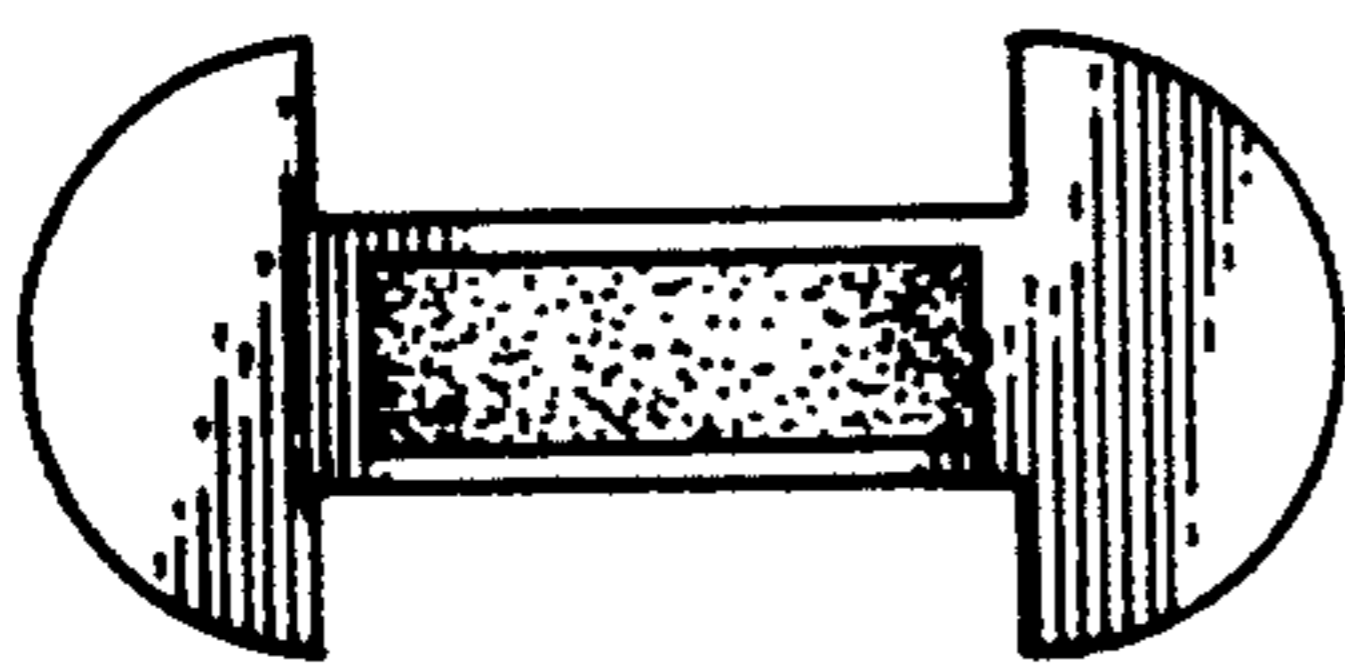

FIG. 9



FIG. 8



FIG. 7

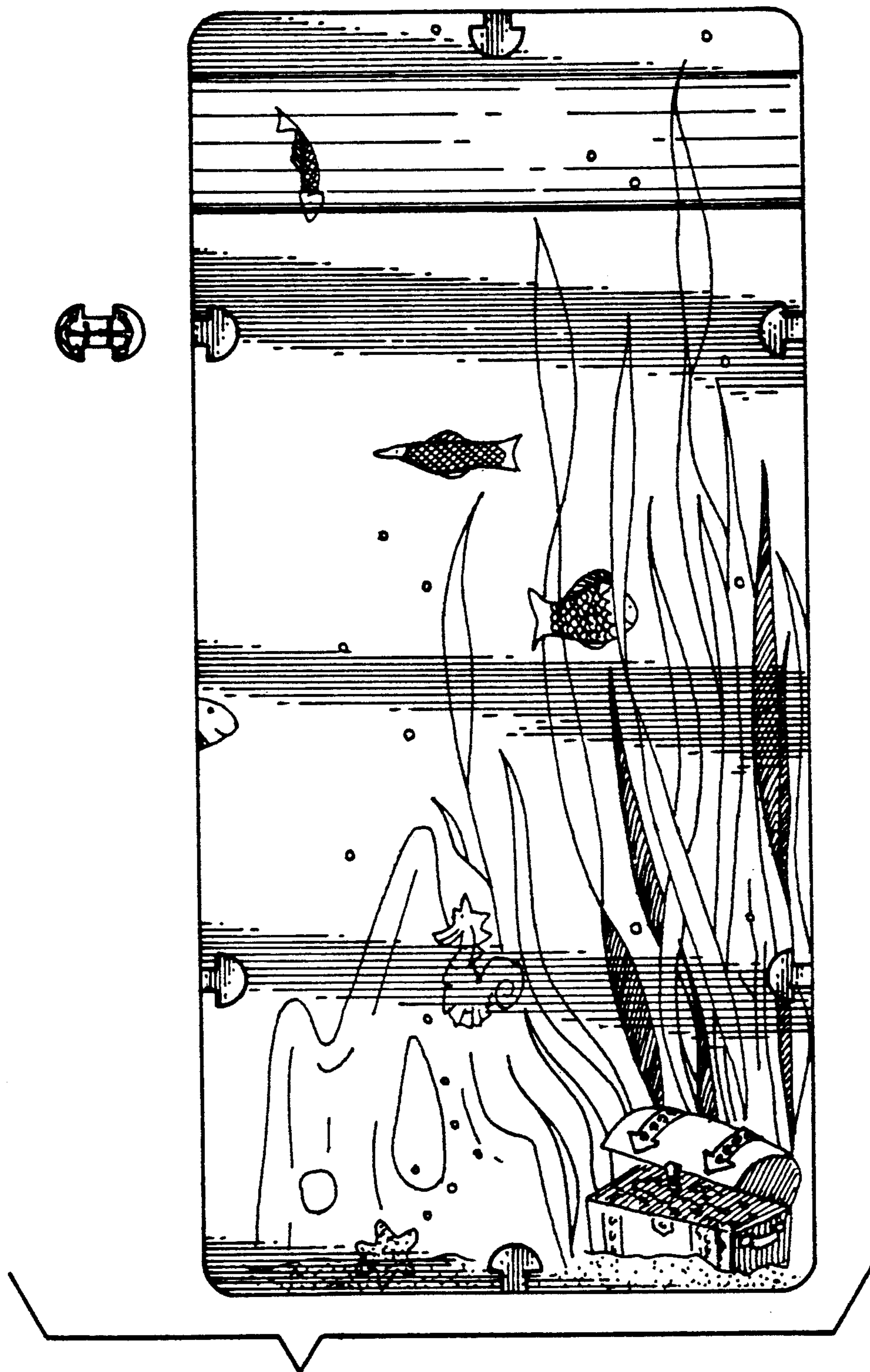

FIG. 10

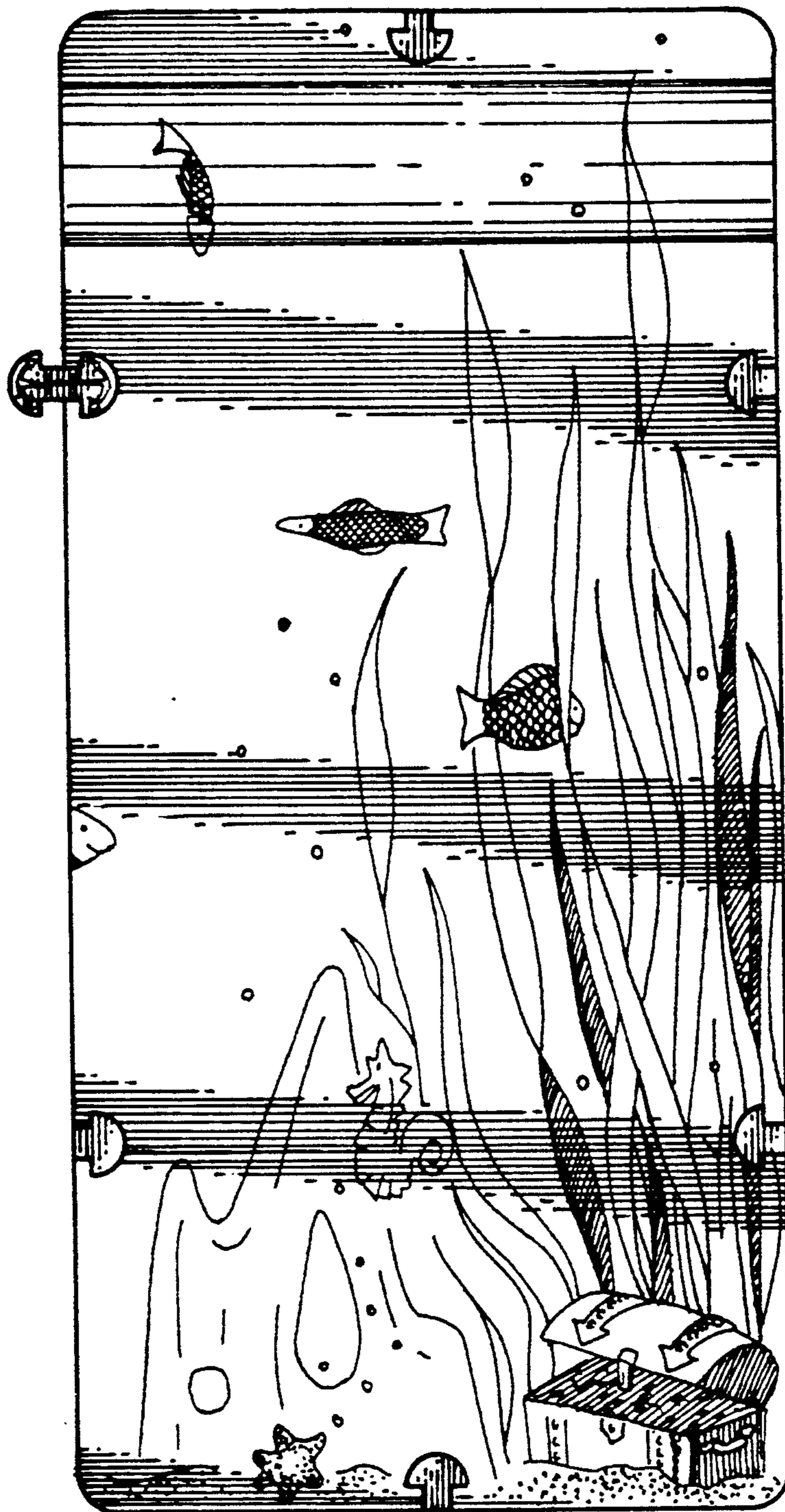

FIG. II