



US00D346587S

United States Patent [19]

[11] Patent Number: **Des. 346,587**

Herman et al.

[45] Date of Patent: **** May 3, 1994**

[54] **CONTOURED TRANSPARENT COVER FOR A PHOTOELECTRIC SWITCH**

[75] Inventors: **Jeffrey G. Herman**, Lake Orion;
Mark C. Matzka, Rochester Hills,
both of Mich.

[73] Assignee: **Break-A-Beam, Inc.**, Warren, Mich.

[**] Term: **14 Years**

[21] Appl. No.: **897,512**

[22] Filed: **Jun. 11, 1992**

[52] U.S. Cl. **D13/177**

[58] Field of Search 200/43.06, 61.02, 333;
250/229; D13/158, 177

[56] **References Cited**

U.S. PATENT DOCUMENTS

2,767,284 10/1956 Moku D13/158 X
4,102,471 7/1978 Lore et al. 200/43.16 X

Primary Examiner—Wallace R. Burke
Assistant Examiner—Joel Sincavage
Attorney, Agent, or Firm—Gifford, Groh, Sprinkle,
Patmore and Anderson

[57] **CLAIM**

The ornamental design for a contoured transparent cover for a photoelectric switch, as shown and described.

DESCRIPTION

FIG. 1 is a perspective of the contoured transparent cover for a photoelectric switch;
FIG. 2 is a top view of the contoured transparent cover;
FIG. 3 is a right-hand side view of the contoured transparent cover;
FIG. 4 is a left-hand side view of the contoured transparent cover;
FIG. 5 is a cross-sectional view of the contoured transparent cover taken along section lines 5—5 of FIG. 2;
FIG. 6 is a bottom view of the contoured transparent cover;
FIG. 7 is a front view of the contoured transparent cover;
FIG. 8 is a rear view of the contoured transparent cover; and,
FIG. 9 is a cross-sectional front view of the contoured transparent cover taken along section lines 9—9 of FIG. 6.

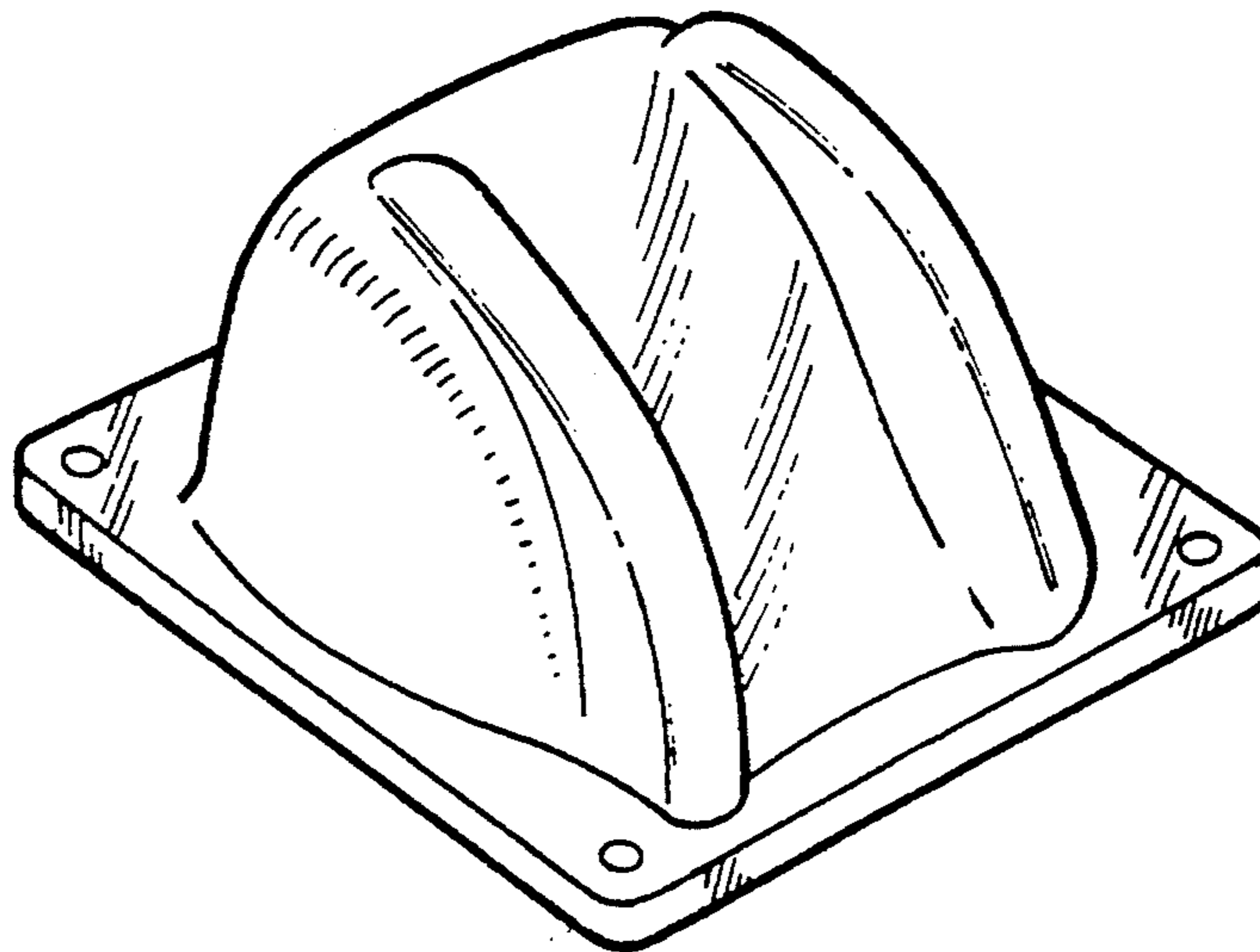

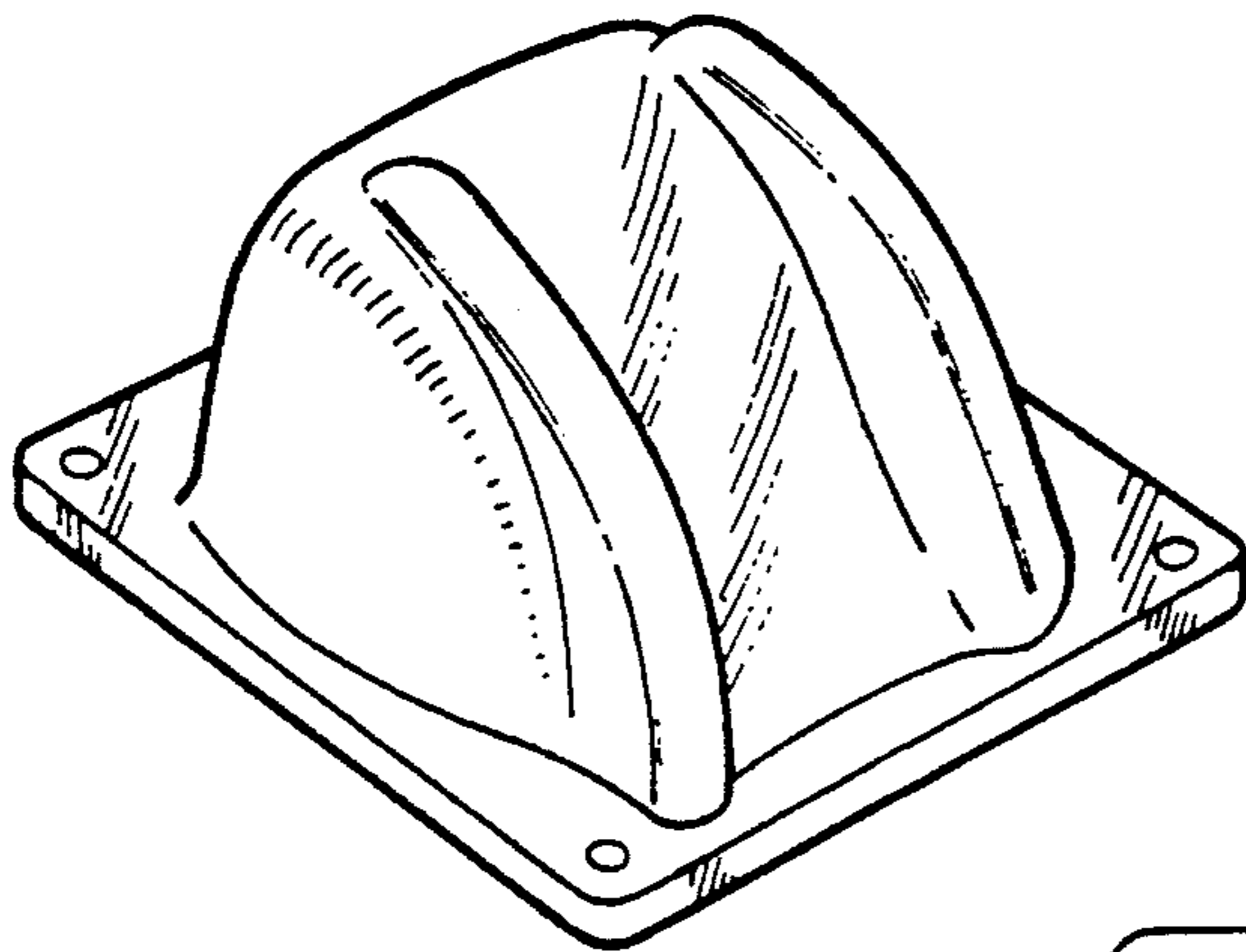

Fig-1

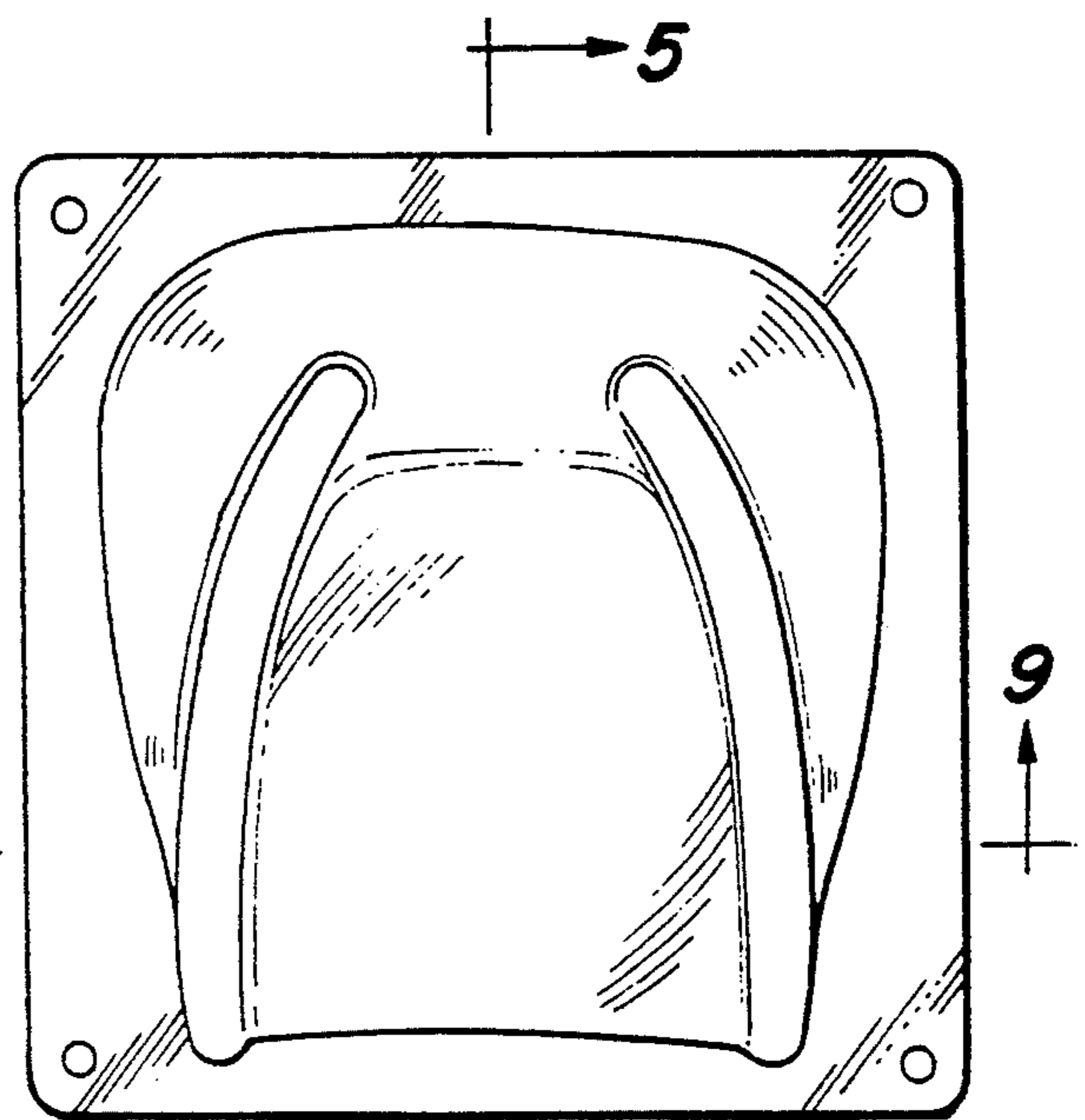

Fig-2

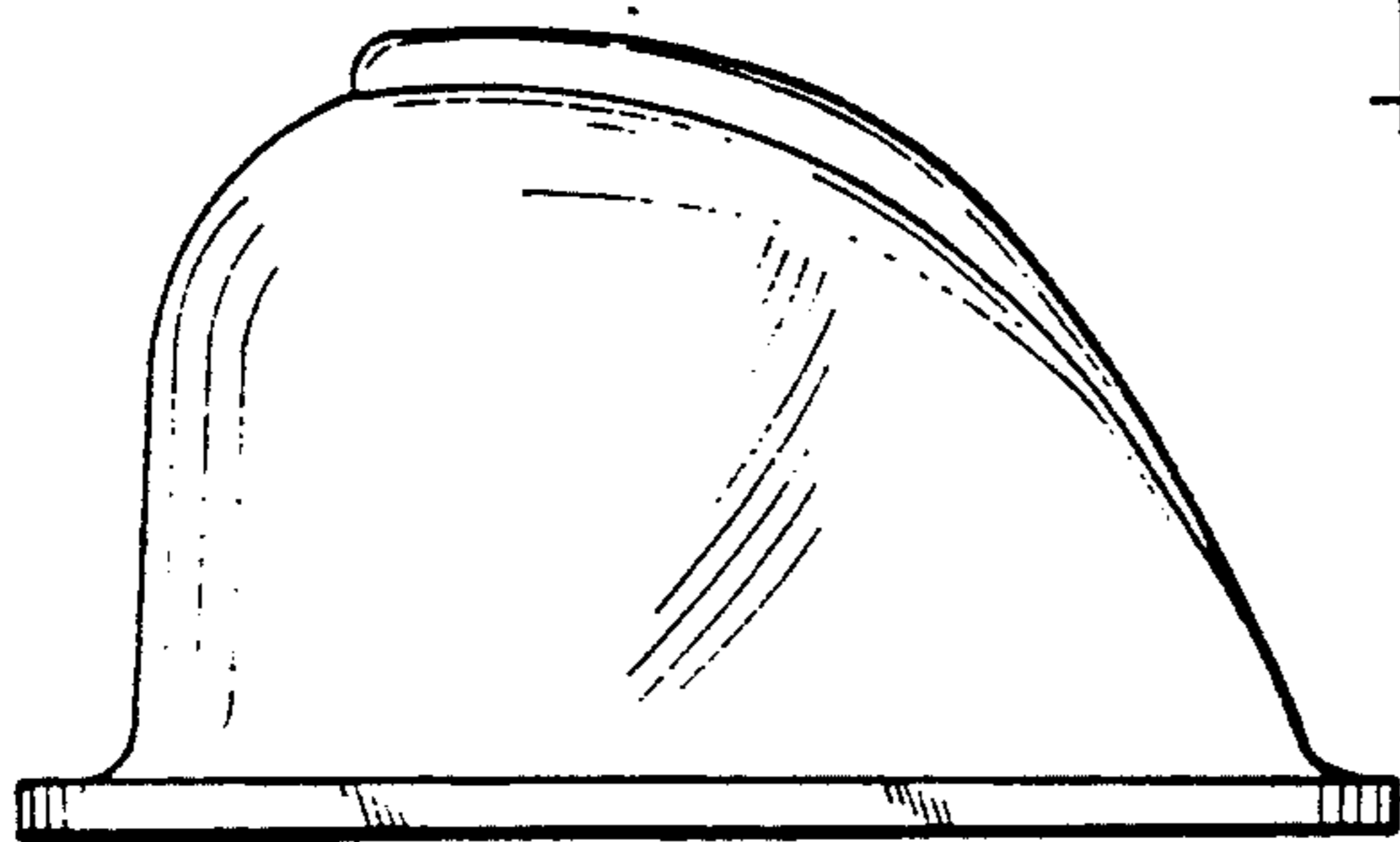

Fig-3

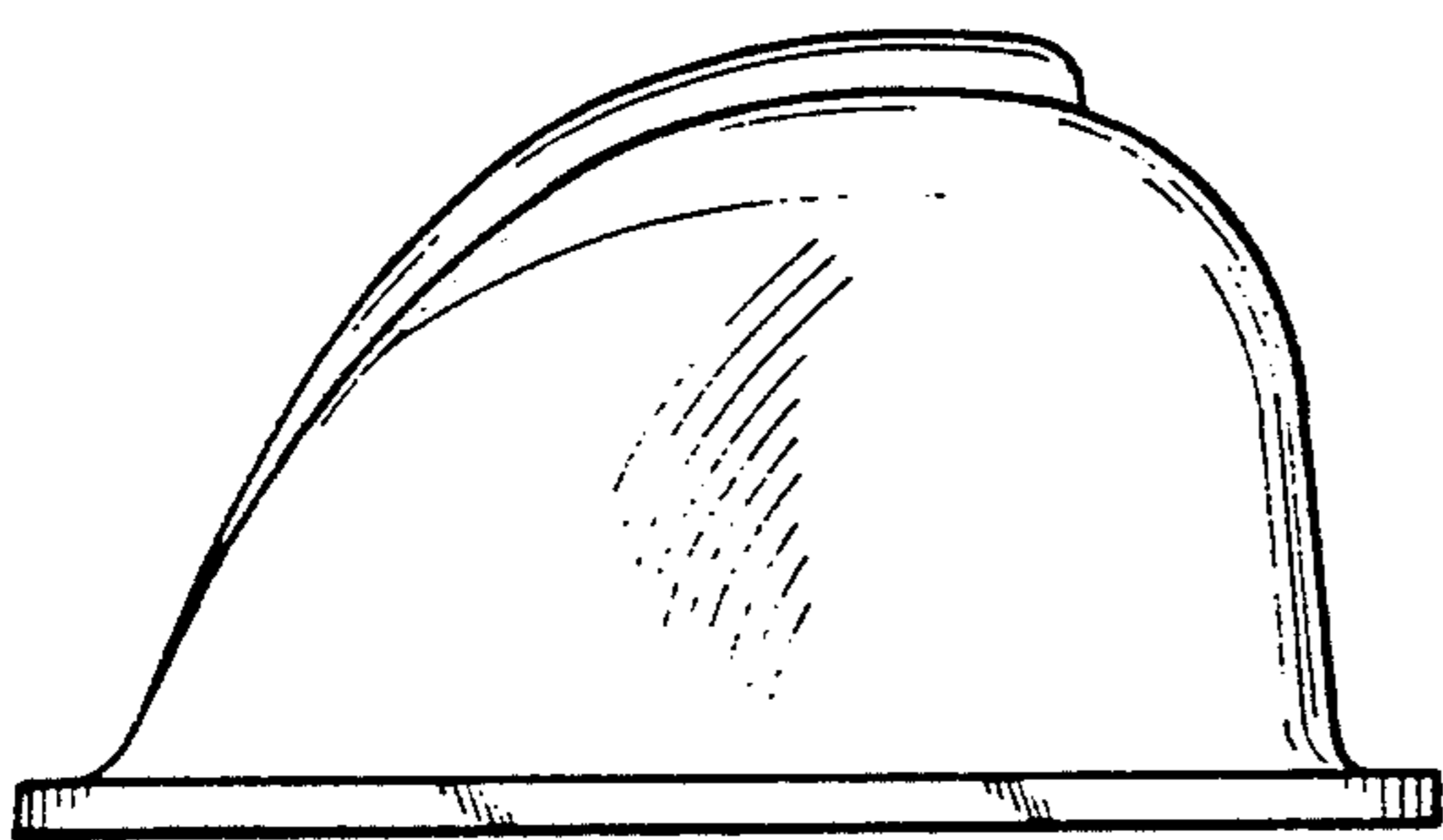

Fig-4

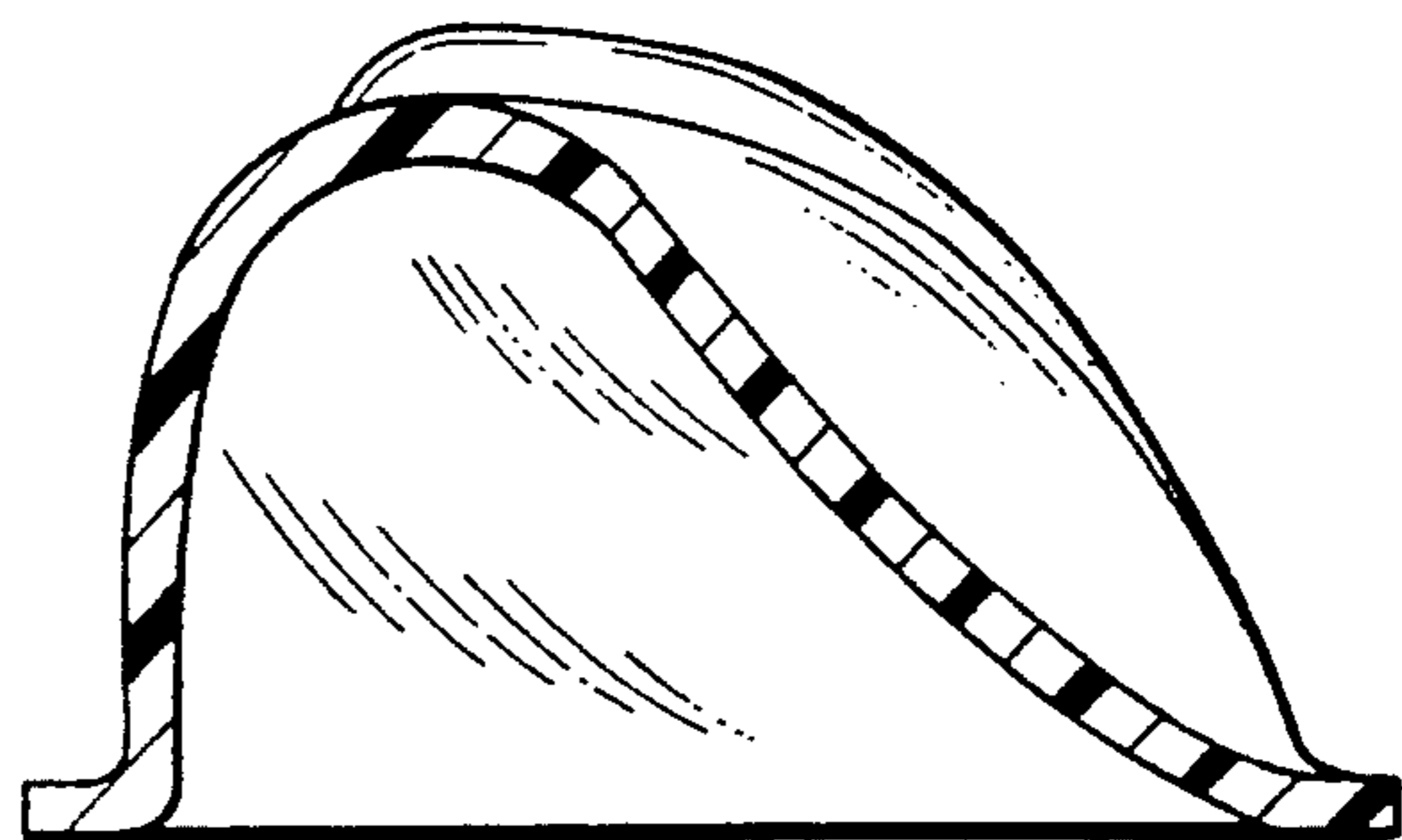

Fig-5

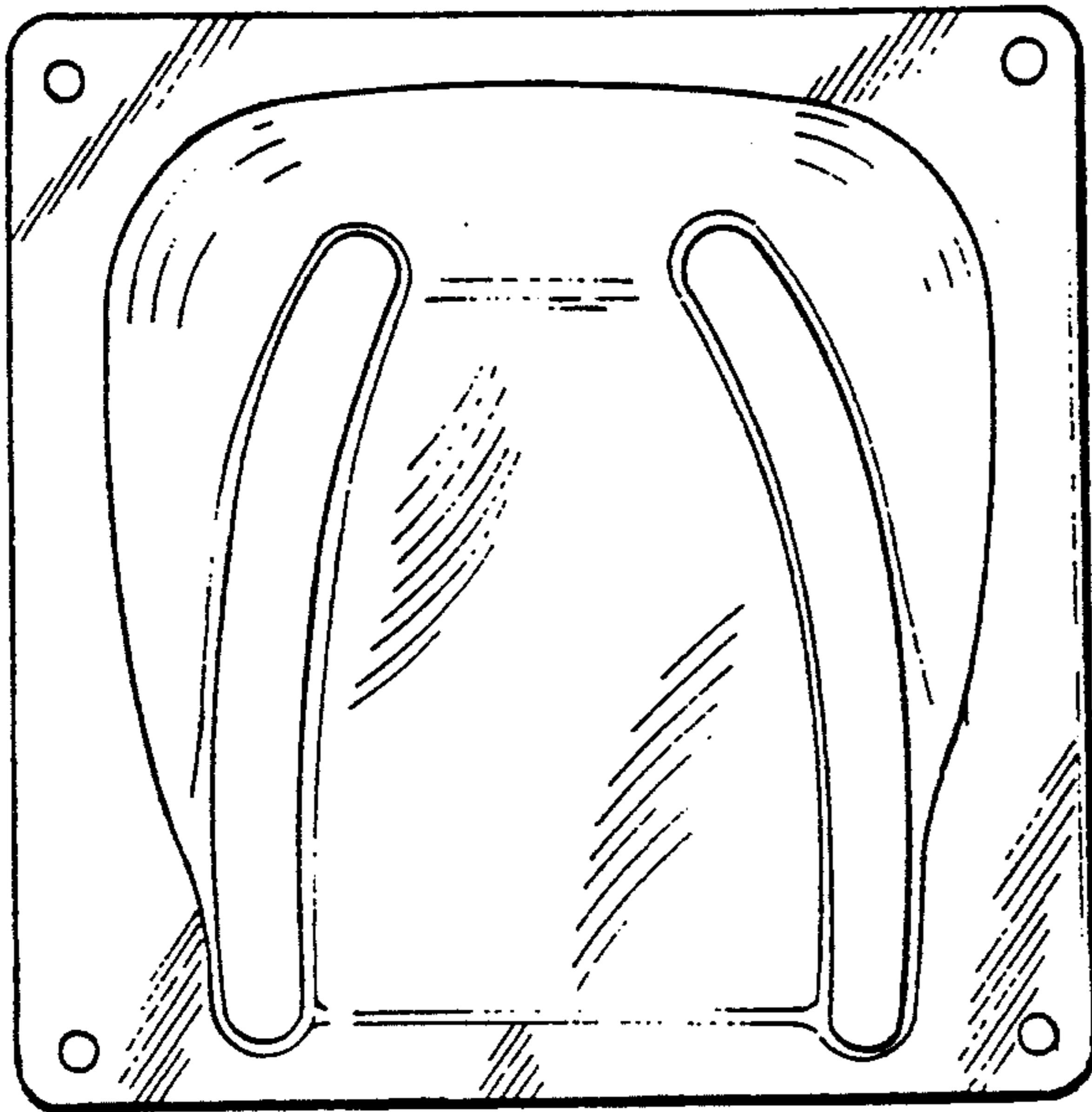

Fig-6

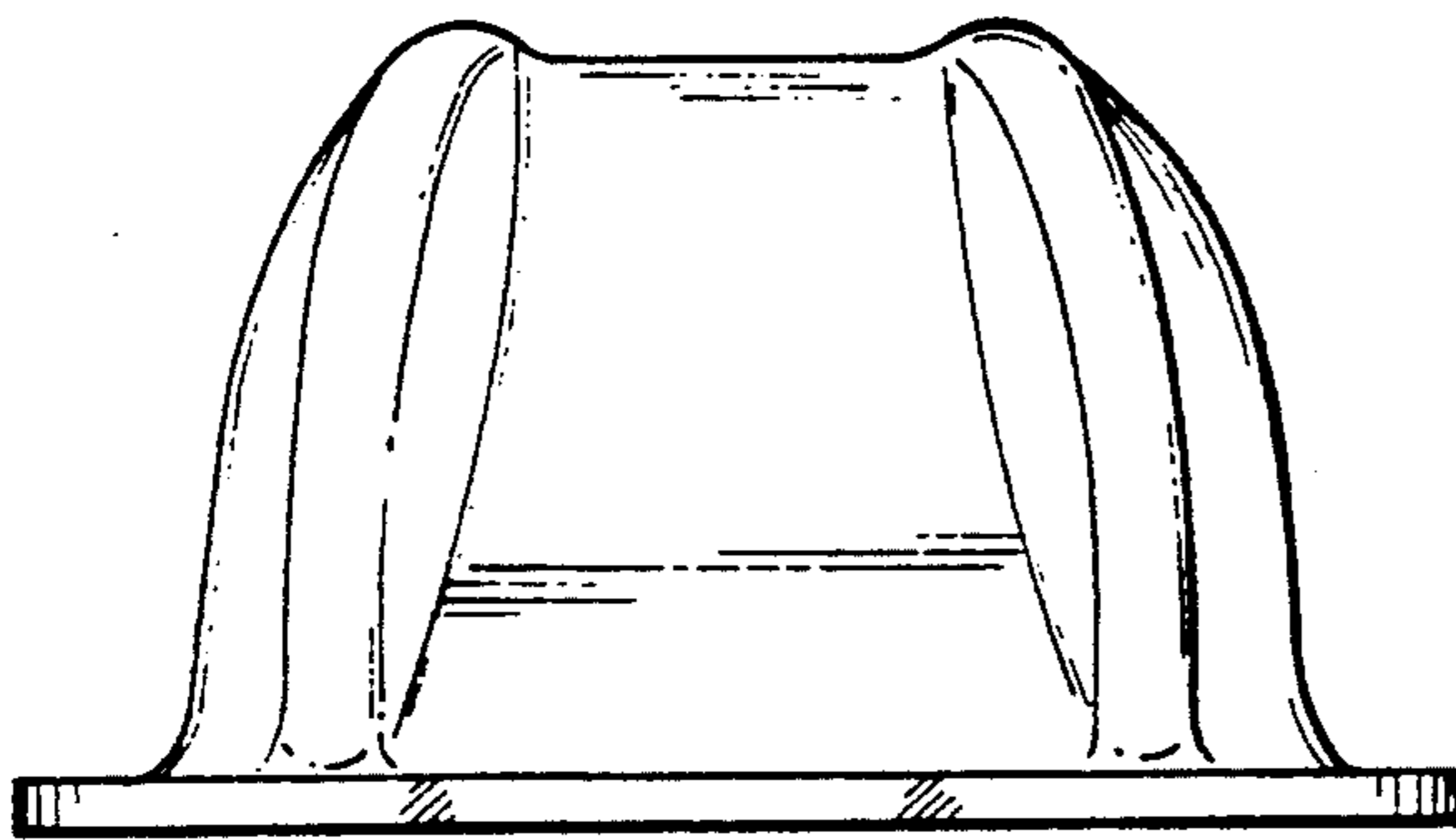

Fig-7

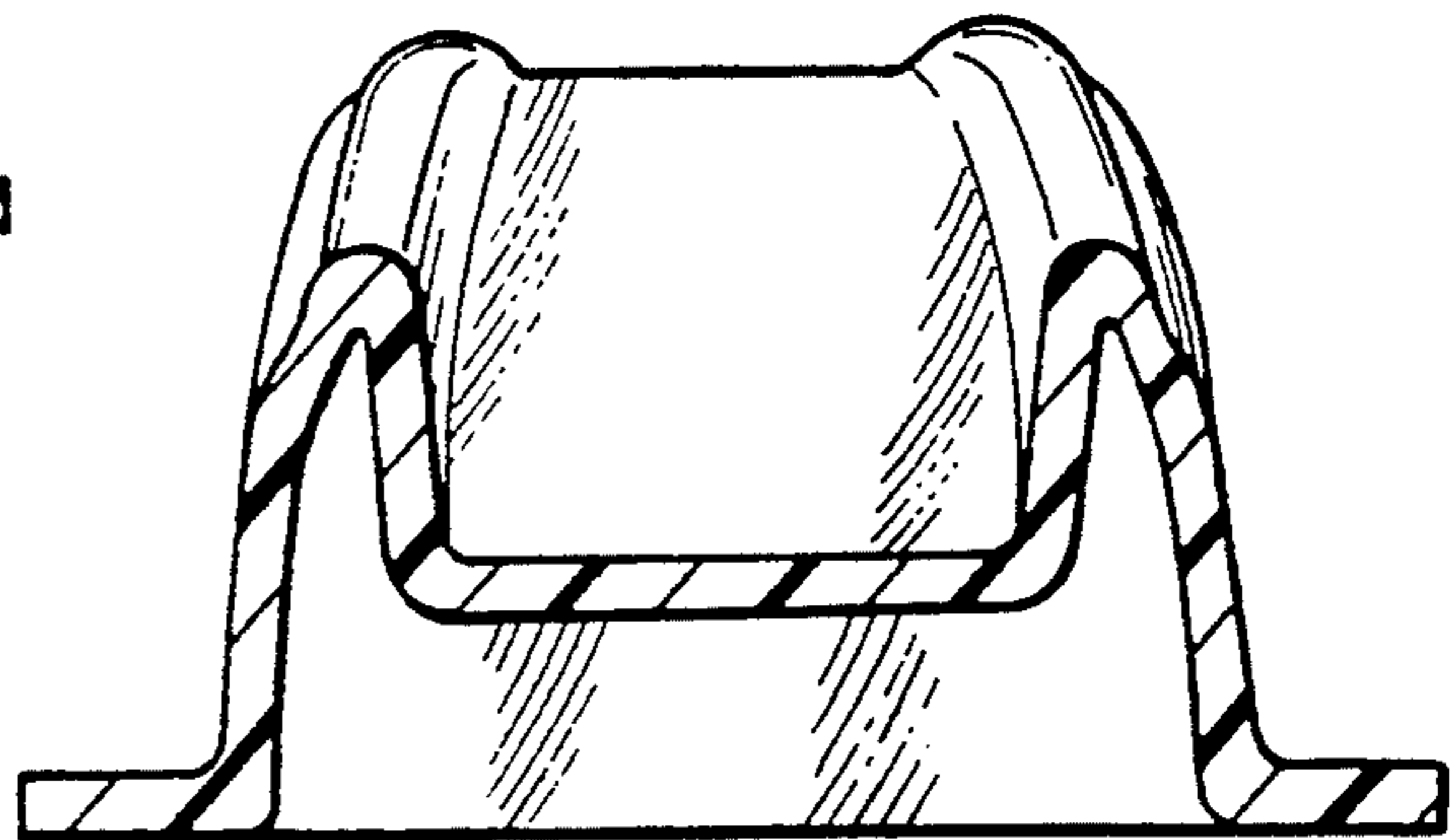

Fig-9

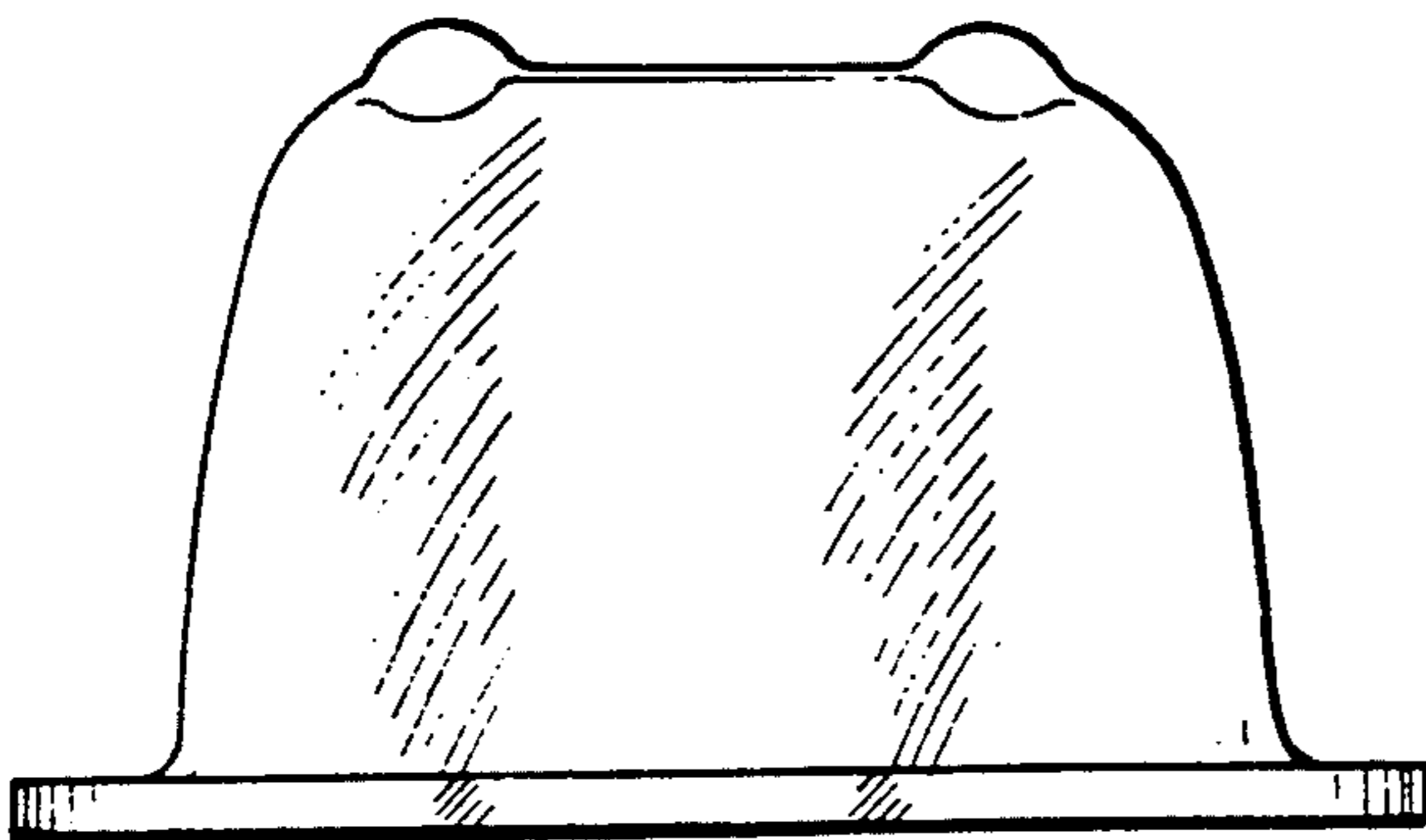

Fig-8