



US00D346575S

United States Patent [19]

[11] Patent Number: **Des. 346,575**

Lussier

[45] Date of Patent: **** May 3, 1994**

[54] **BICYCLE BRAKE HANDLE**

5,123,296 6/1992 Chang 74/502.2

[76] Inventor: **Cleément Lussier**, 821
Henri-Bourassa, Marieville, Quebec,
Canada, J0L 1J0

OTHER PUBLICATIONS

American Bicyclist & Motorcyclist, Aug. 1991, p. 47,
The Chang Yi Industry Co., Ltd., brake levers nos.
197P and 199AP.

[**] Term: **14 Years**

Primary Examiner—Wallace R. Burke
Assistant Examiner—Melody Brown

[21] Appl. No.: **882,528**

[22] Filed: **May 13, 1992**

[57] **CLAIM**

[30] **Foreign Application Priority Data**

The ornamental design for a bicycle brake handle, as
shown.

Dec. 20, 1991 [CA] Canada 2012918

[52] U.S. Cl. **D12/179**

[58] Field of Search 74/489, 475, 551.8,
74/551.9, 502.2; D12/179

DESCRIPTION

[56] **References Cited**

FIG. 1 is a top elevational view of the bicycle brake
handle, showing my new design;
FIG. 2 is a bottom elevational view thereof;
FIG. 3 is a right side elevational view thereof;
FIG. 4 is a left side elevational view thereof;
FIG. 5 is a front elevational view thereof; and,
FIG. 6 is a bottom plan view thereof.

U.S. PATENT DOCUMENTS

D. 232,823 9/1974 Carlson et al. D12/179
4,611,500 9/1986 Nagano 74/489
4,909,094 3/1990 Yoshigsi 74/489

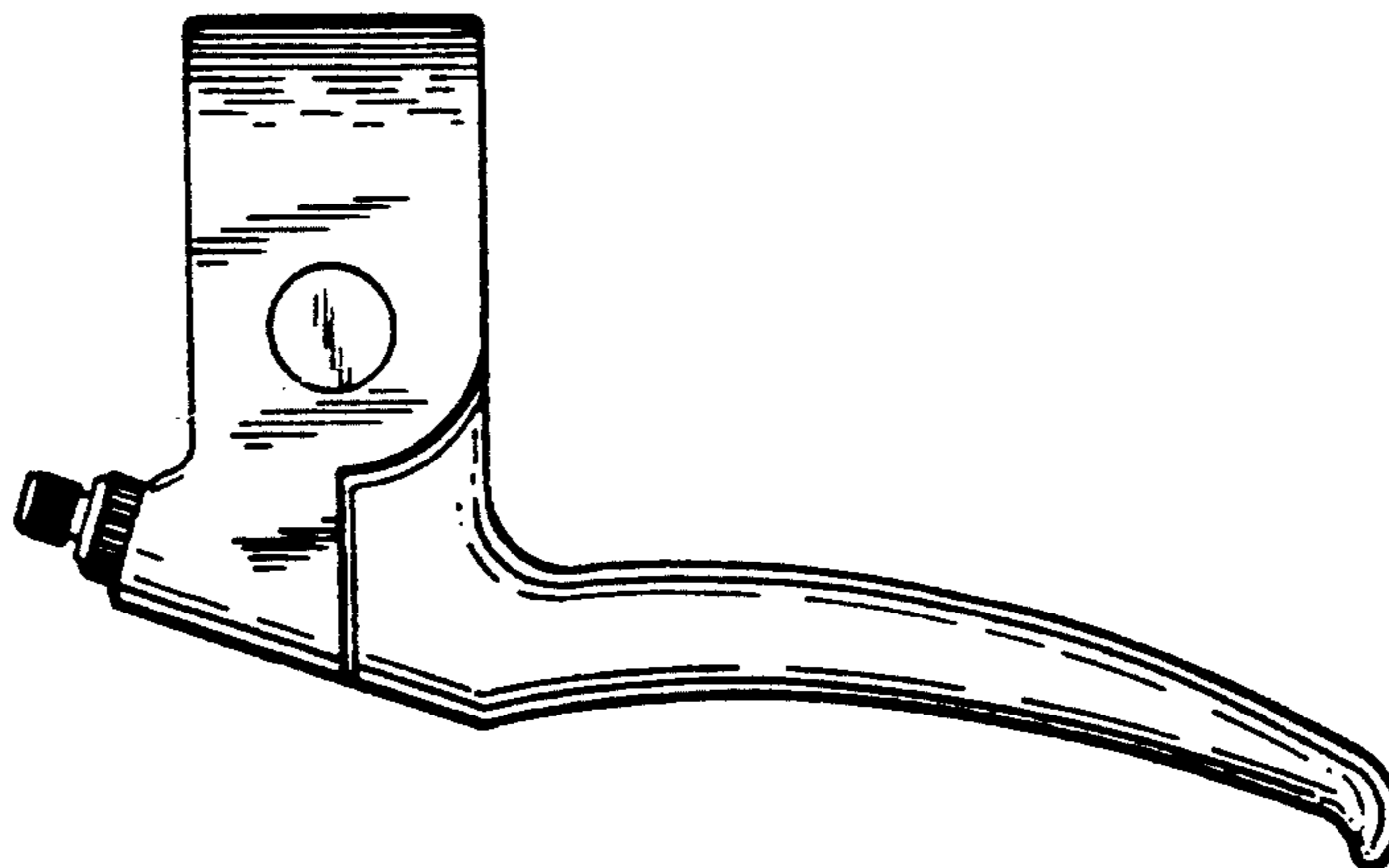

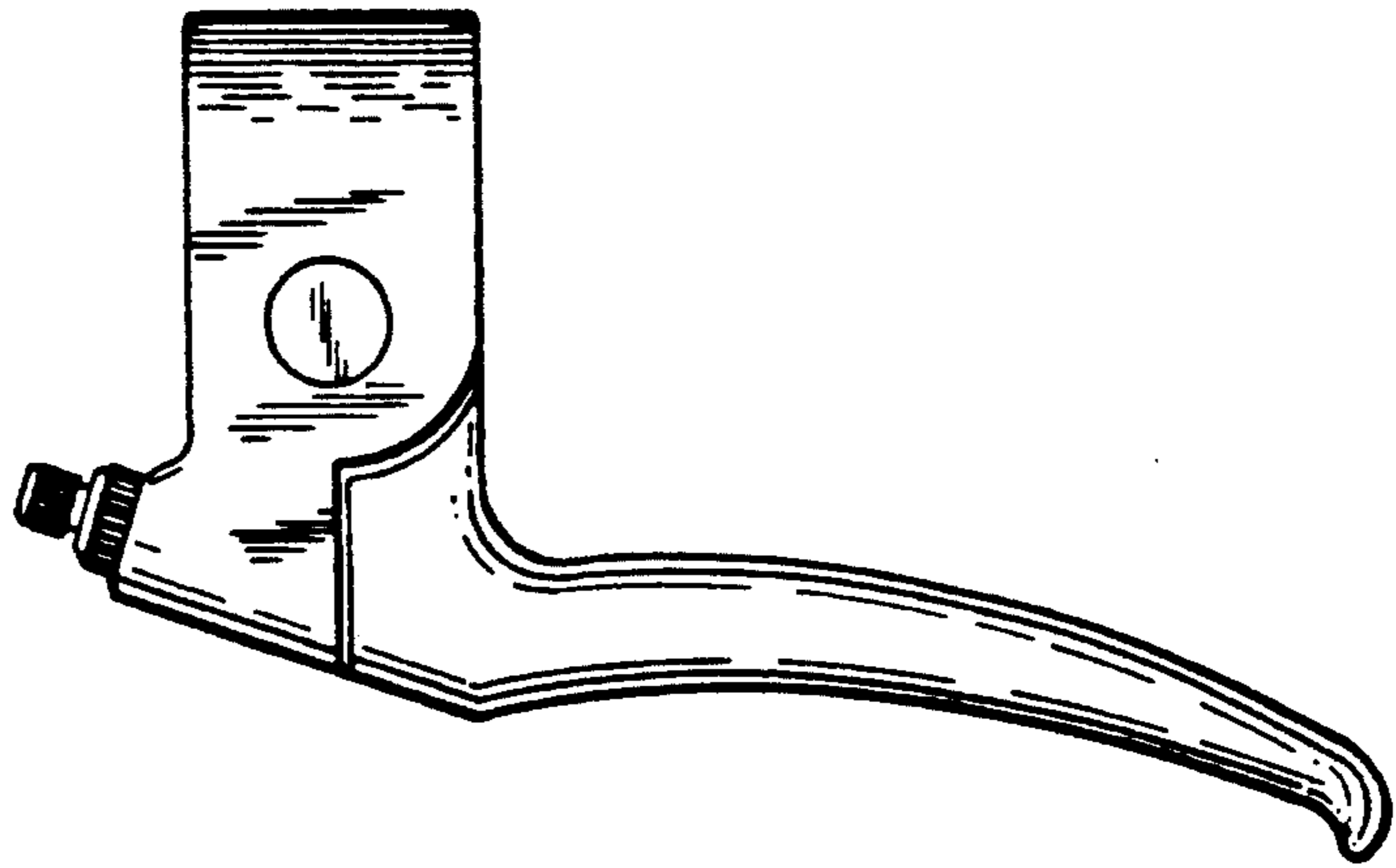

FIG. 1

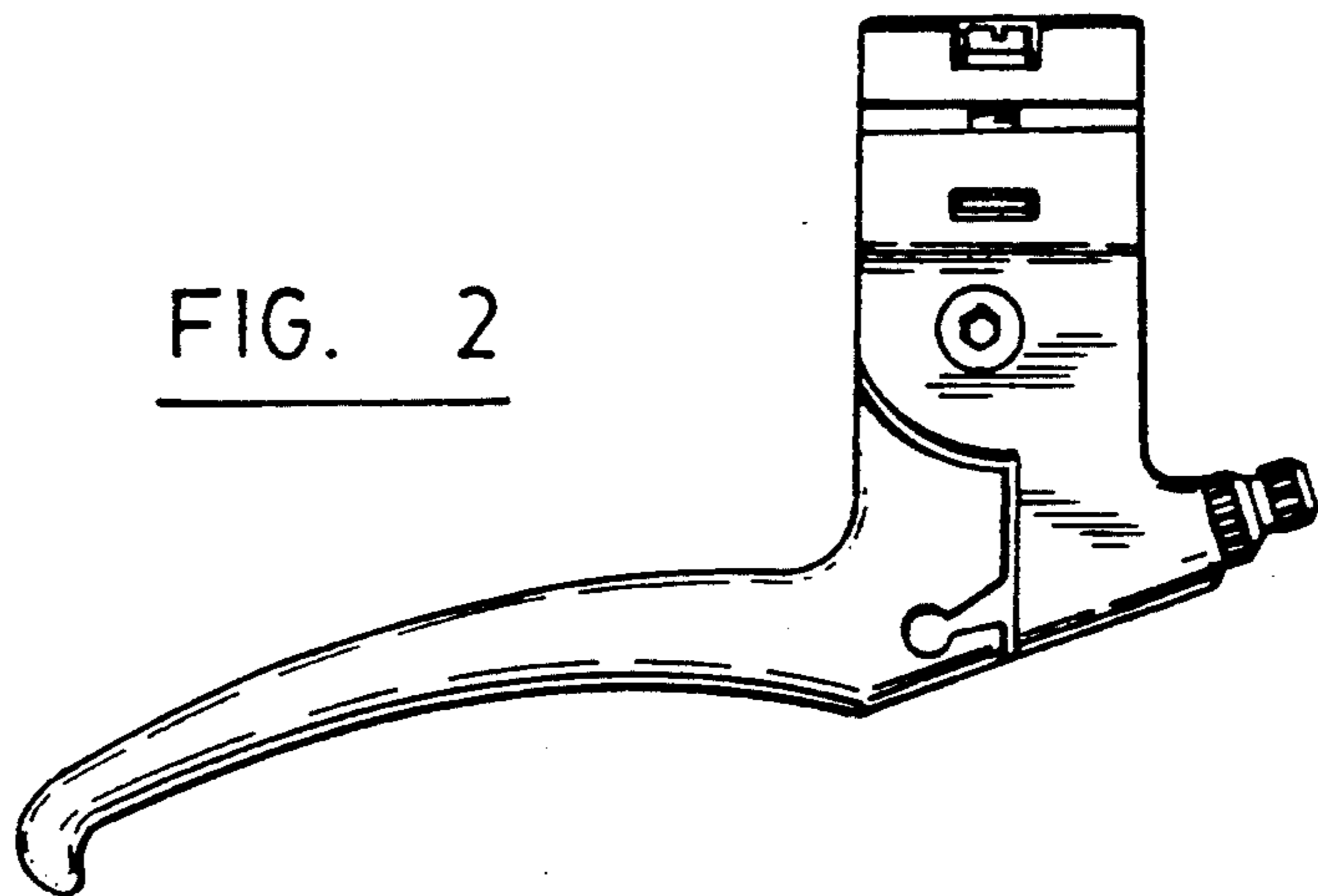

FIG. 2

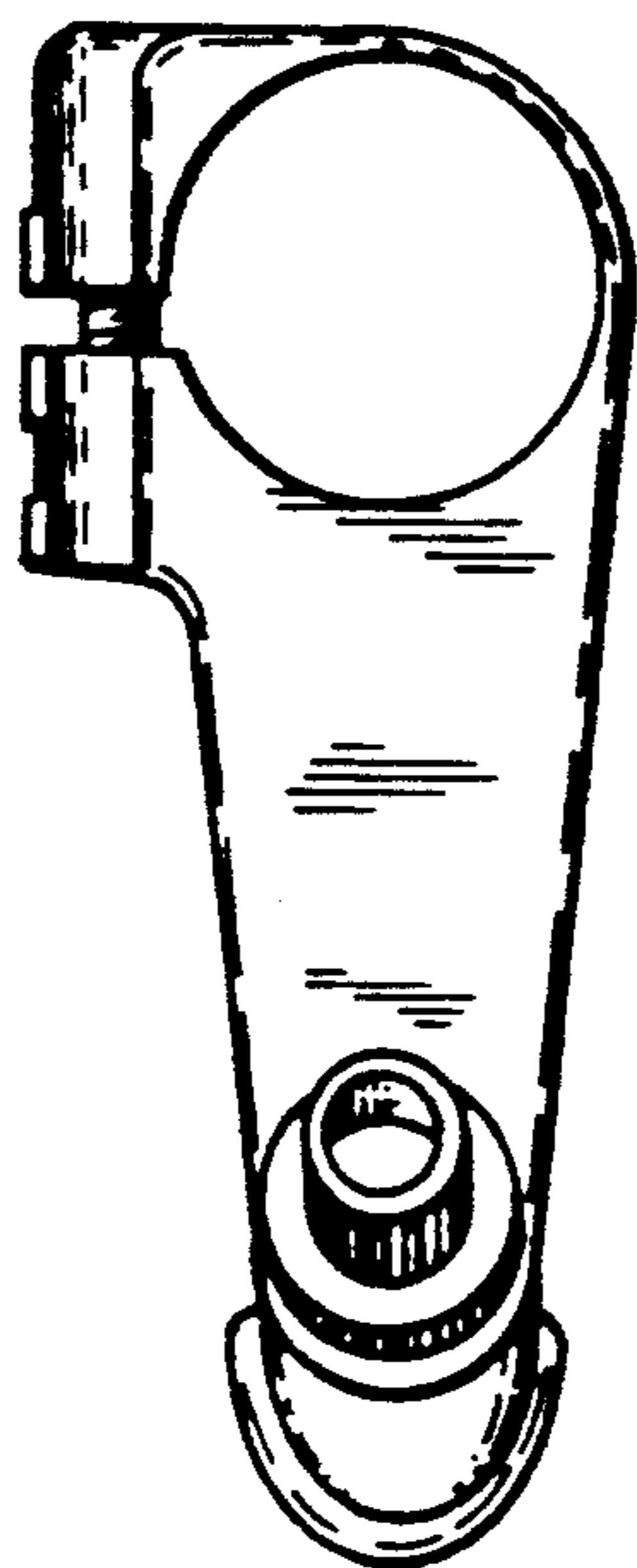

FIG. 3

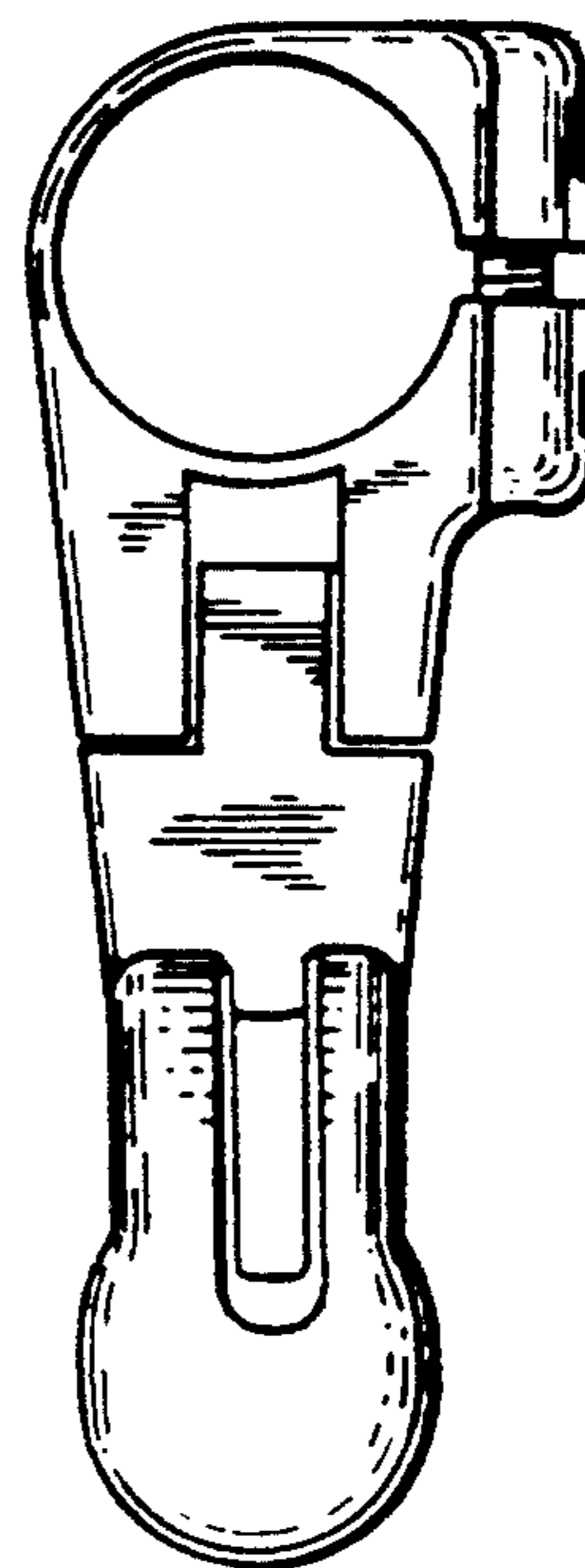

FIG. 4

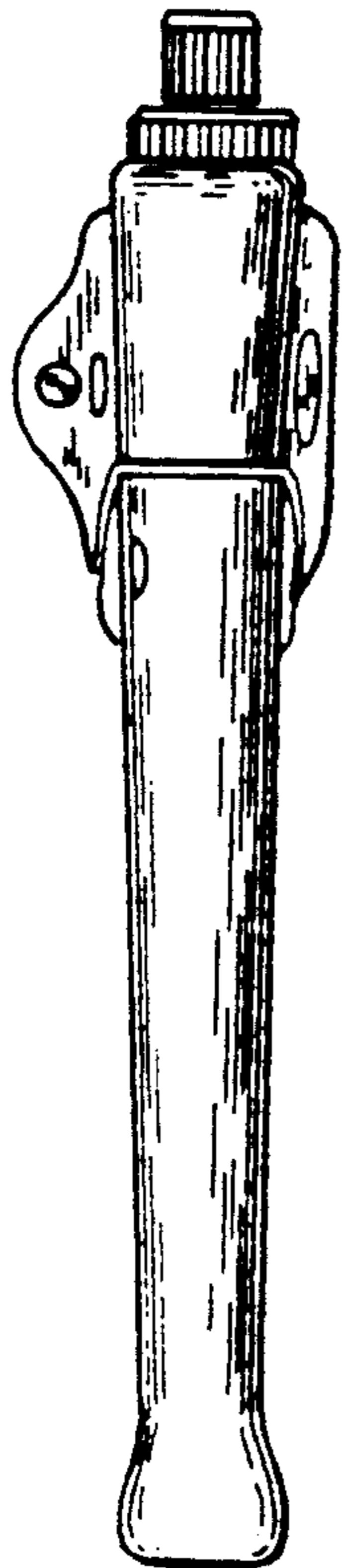

FIG. 5

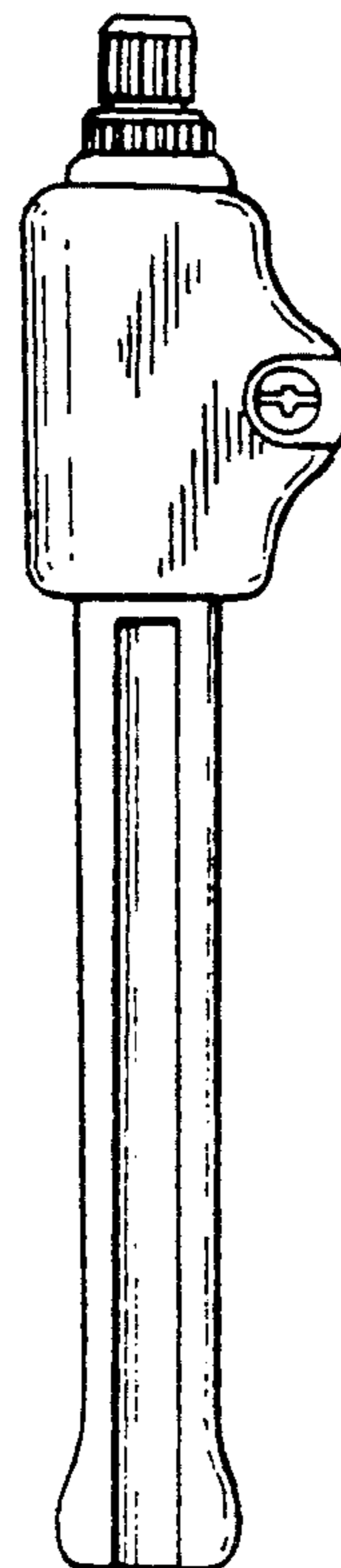

FIG. 6