



US00D346494S

# United States Patent [19]

[11] Patent Number: **Des. 346,494**

Graham et al.

[45] Date of Patent: **\*\* May 3, 1994**

- [54] **PORTABLE CELLULAR TELEPHONE CARRYING CASE WITH EXPANDABLE, EASY-ACCESS TO BATTERY**
- [75] Inventors: **Nancy A. Graham**, Lawrenceville, Ga.; **Adel Ojaghi**, Highland Park, N.J.
- [73] Assignee: **Oki Telecom**, Suwanee, Ga.
- [\*\*] Term: **14 Years**
- [21] Appl. No.: **1,102**
- [22] Filed: **Nov. 3, 1992**
- [52] U.S. Cl. .... **D3/218; D14/250**
- [58] Field of Search ..... **D3/100, 106, 30.1; 224/901, 253, 240; D14/250, 253**

### [56] References Cited

#### U.S. PATENT DOCUMENTS

D. 250,919	1/1979	Milligan et al. ....	D3/106
D. 288,865	3/1987	Nace .....	D3/106
D. 293,628	1/1988	Teachy .....	D3/106
D. 294,827	3/1988	Woodfork .....	D14/250
D. 306,654	3/1990	Brown .....	D3/106
D. 307,673	5/1990	Brown .....	D3/106
D. 317,452	6/1991	Garab .....	D14/250
D. 322,719	12/1991	Jayez .....	D3/106 X
4,948,022	8/1990	Van Dyke .....	224/901

*Primary Examiner*—Alan P. Douglas  
*Assistant Examiner*—Jeffrey Asch  
*Attorney, Agent, or Firm*—Louis T. Isaf

### [57] CLAIM

The ornamental design for portable cellular telephone carrying case with expandable, easy-access to battery, as shown and described.

### DESCRIPTION

FIG. 1 is a perspective view of a portable cellular telephone carrying case with expandable, easy-access to battery, in accordance with a first embodiment of the present invention showing our new design;  
 FIG. 2 is a left side view thereof;  
 FIG. 3 is a right side view thereof;  
 FIG. 4 is a top view thereof;  
 FIG. 5 is a bottom view thereof;  
 FIG. 6 is a rear view thereof;

FIG. 7 is a front view thereof;  
 FIG. 8 is a top view thereof, in an open configuration;  
 FIG. 9 is a bottom view thereof, in an open configuration;  
 FIG. 10 is a perspective view of a portable cellular telephone carrying case with expandable easy-access to battery in accordance with a second embodiment of the present invention;  
 FIG. 11 is a left side view thereof;  
 FIG. 12 is a right side view thereof;  
 FIG. 13 is a top view thereof;  
 FIG. 14 is a bottom view thereof;  
 FIG. 15 is a rear view thereof;  
 FIG. 16 is a front view thereof;  
 FIG. 17 is a top view thereof, in an open configuration;  
 FIG. 18 is a bottom view thereof, in an open configuration;  
 FIG. 19 is a bottom view of a portable cellular telephone carrying case with expandable, easy-access to battery, in accordance with a third embodiment of the present invention;  
 FIG. 20 is a left side view thereof;  
 FIG. 21 is a right side view thereof;  
 FIG. 22 is a top view thereof;  
 FIG. 23 is a bottom view thereof;  
 FIG. 24 is a top view thereof, in an open configuration;  
 FIG. 25 is a bottom view thereof, in an open configuration;  
 FIG. 26 is a bottom view of a portable cellular telephone carrying case with expandable, easy-access to battery, in accordance with a fourth embodiment of the present invention;  
 FIG. 27 is a left side view thereof;  
 FIG. 28 is a right side view thereof;  
 FIG. 29 is a top view thereof;  
 FIG. 30 is a bottom view thereof;  
 FIG. 31 is a top view thereof, in an open configuration;  
 FIG. 32 is a bottom view thereof, in an open configuration;  
 FIG. 33 is a bottom view of a portable cellular telephone carrying case with expandable, easy-access to battery, in accordance with a fifth embodiment of the present invention;  
 FIG. 34 is a left side view thereof;  
 FIG. 35 is a right side view thereof;

(List continued on next page.)

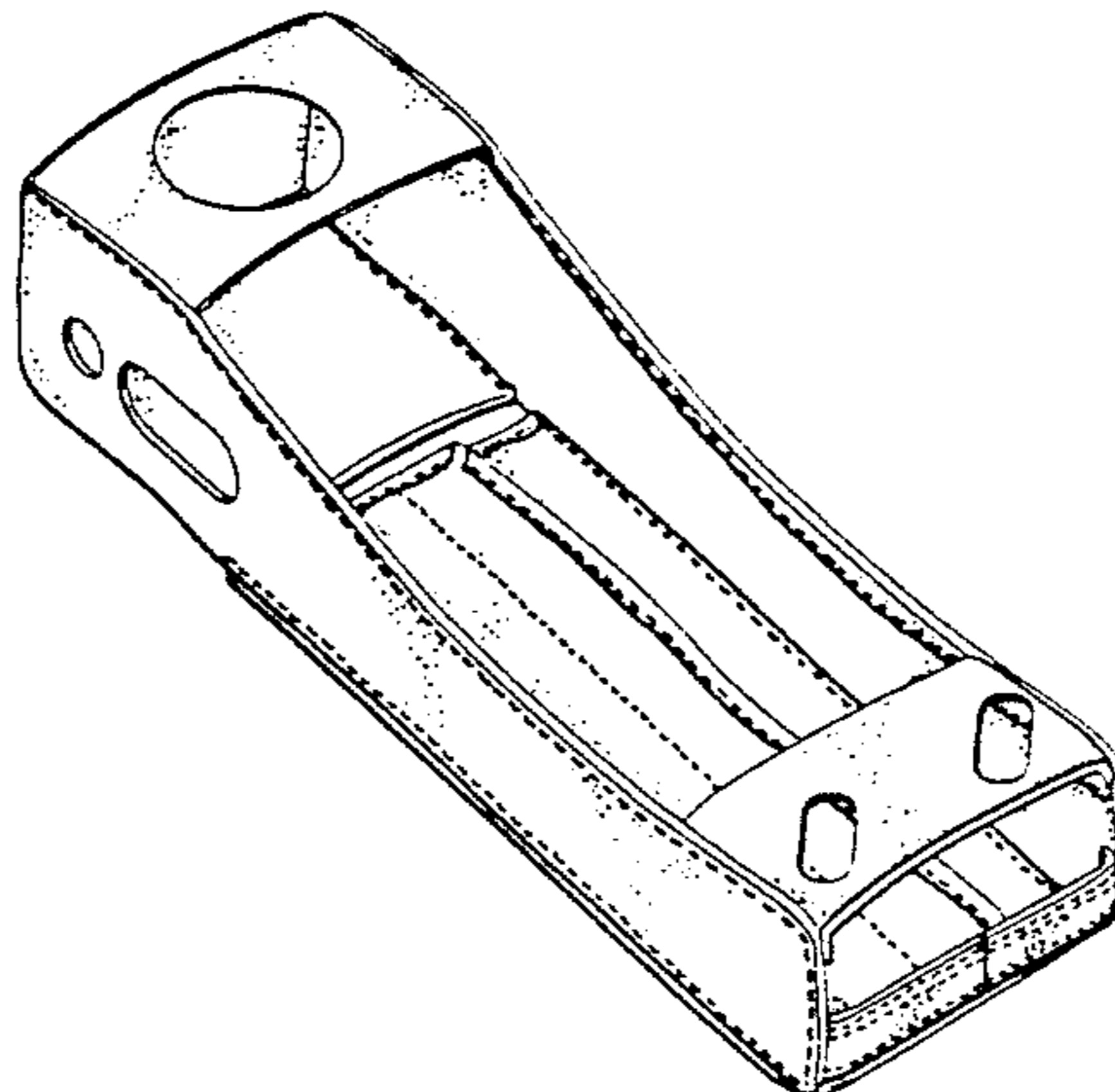
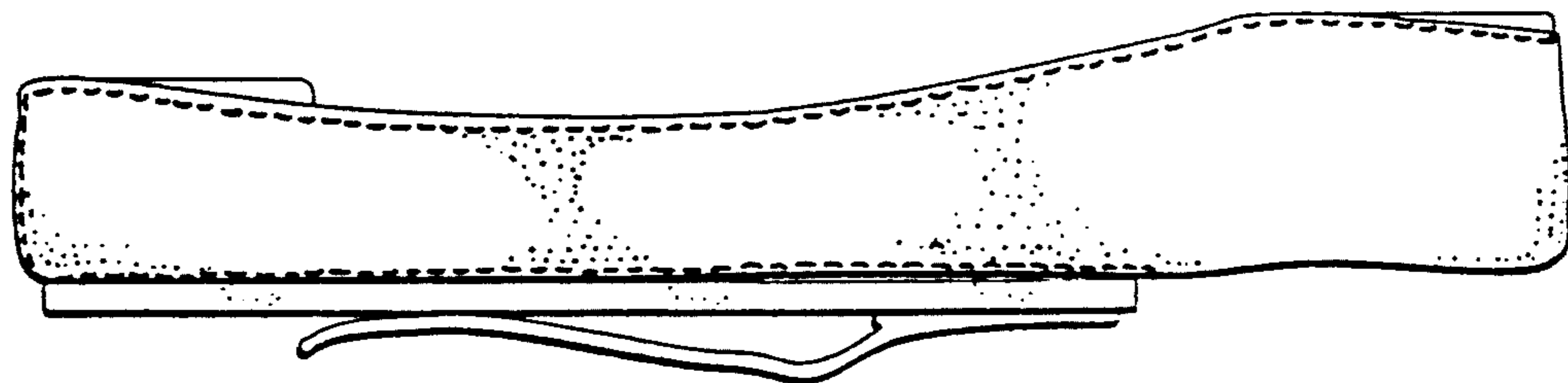
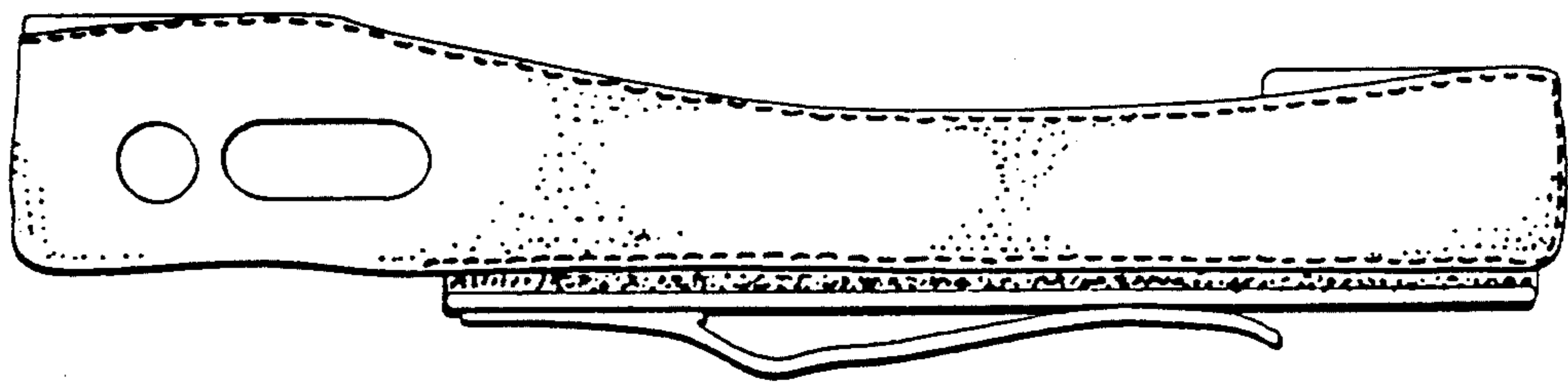
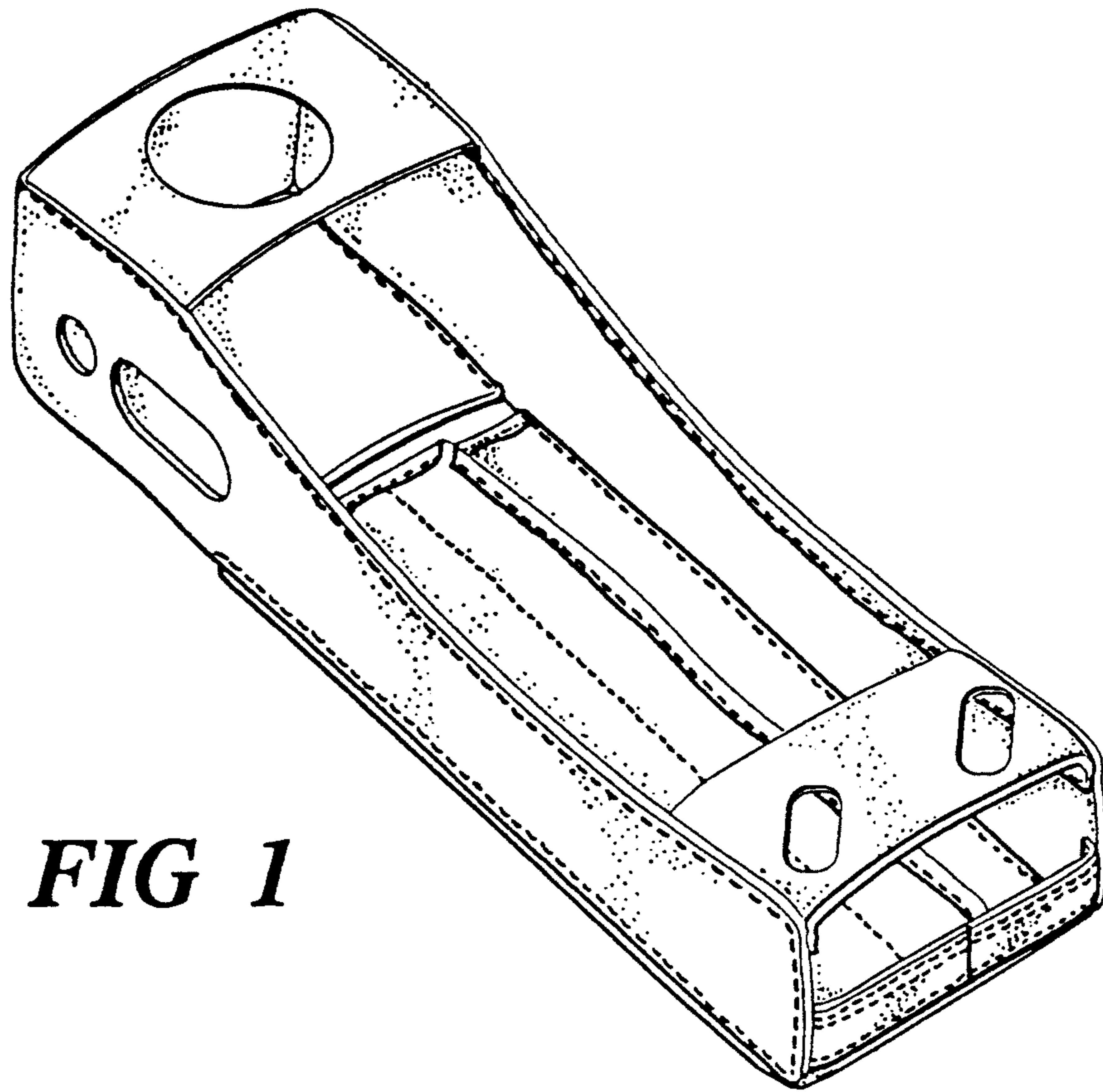
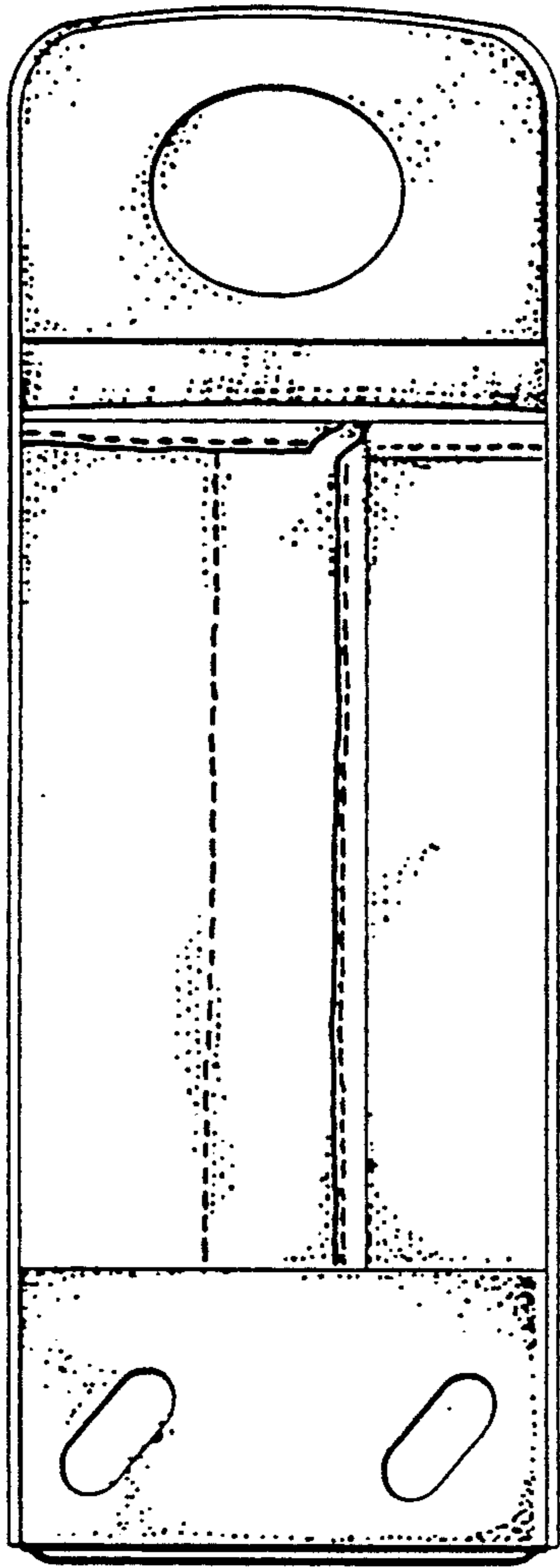


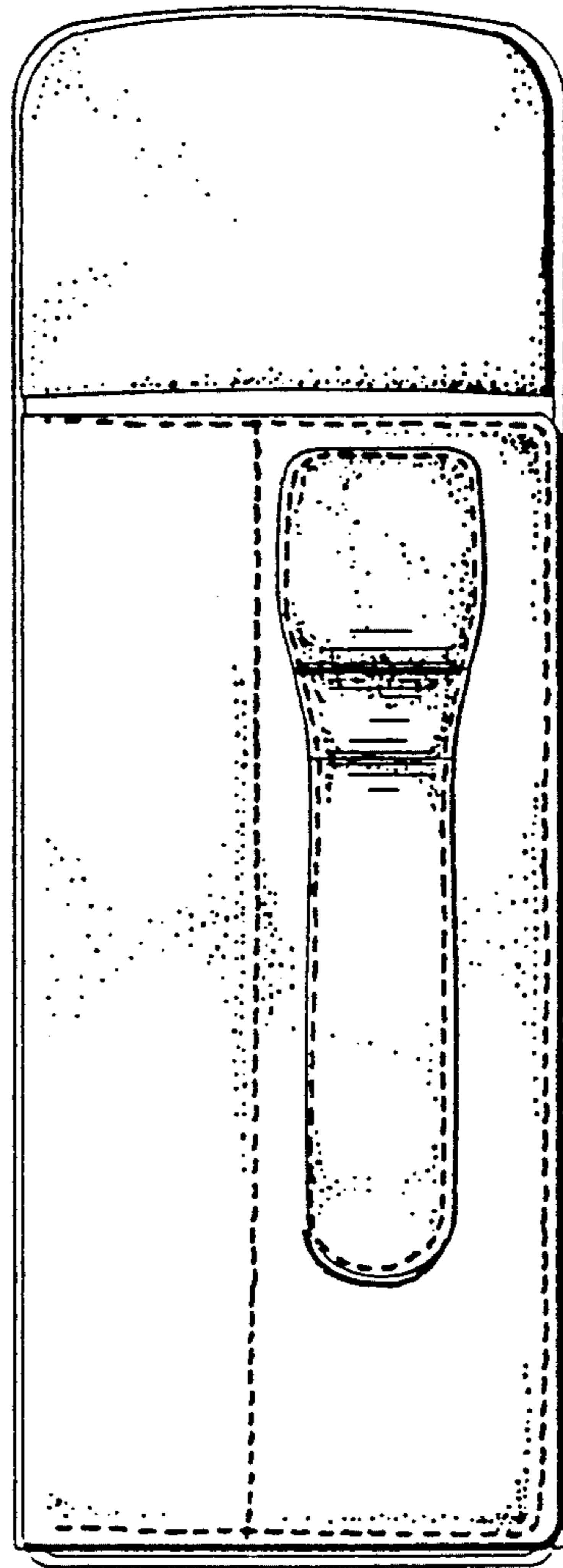
FIG. 36 is a top view thereof;  
FIG. 37 is a bottom view thereof;  
FIG. 38 is a top view thereof, in an open configuration;  
and,

FIG. 39 is a bottom view thereof, in an open configuration.  
The broken line showing of apertures in FIGS. 10-18 are for illustrative purposes only and form no part of the claimed design.

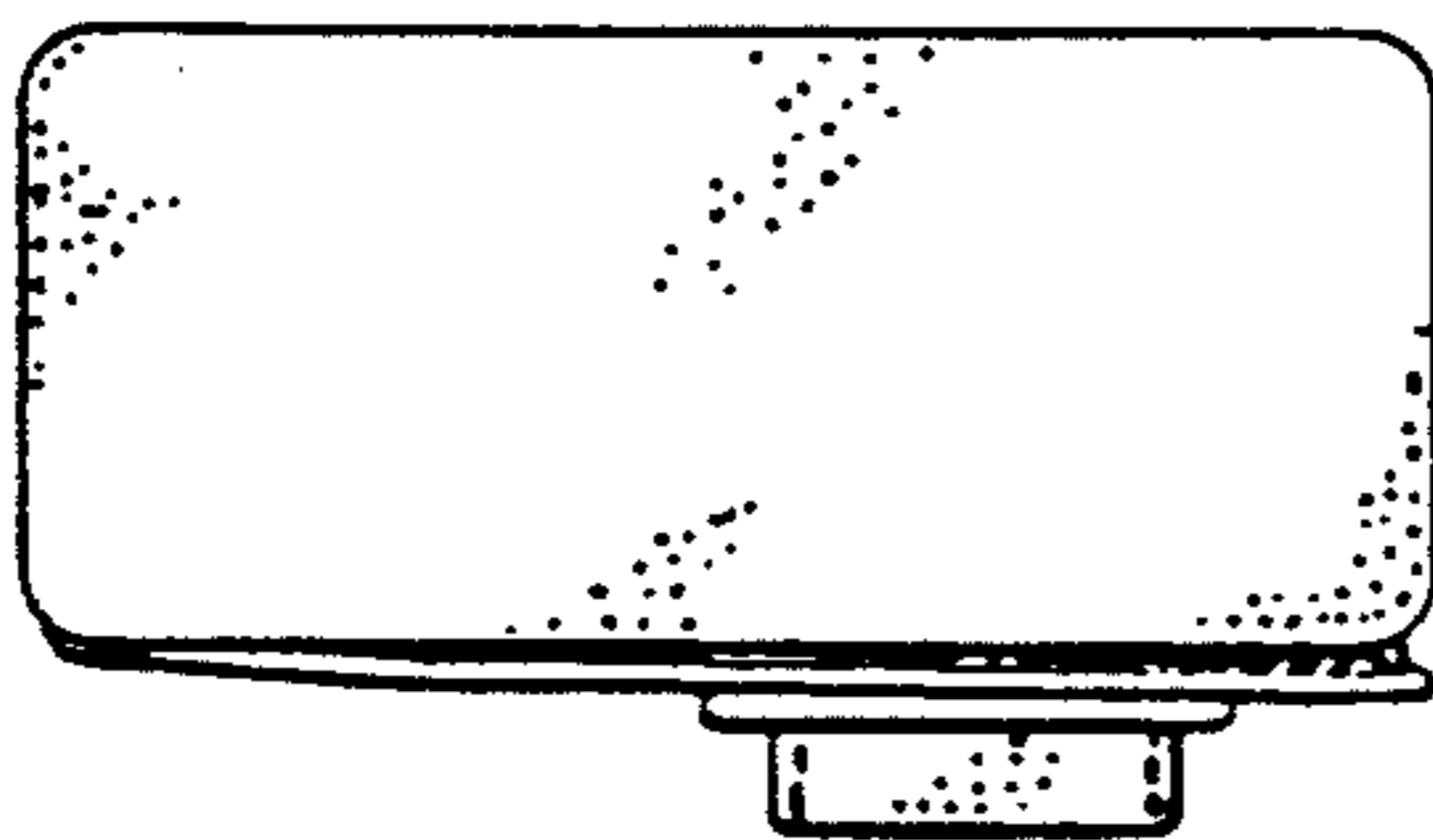




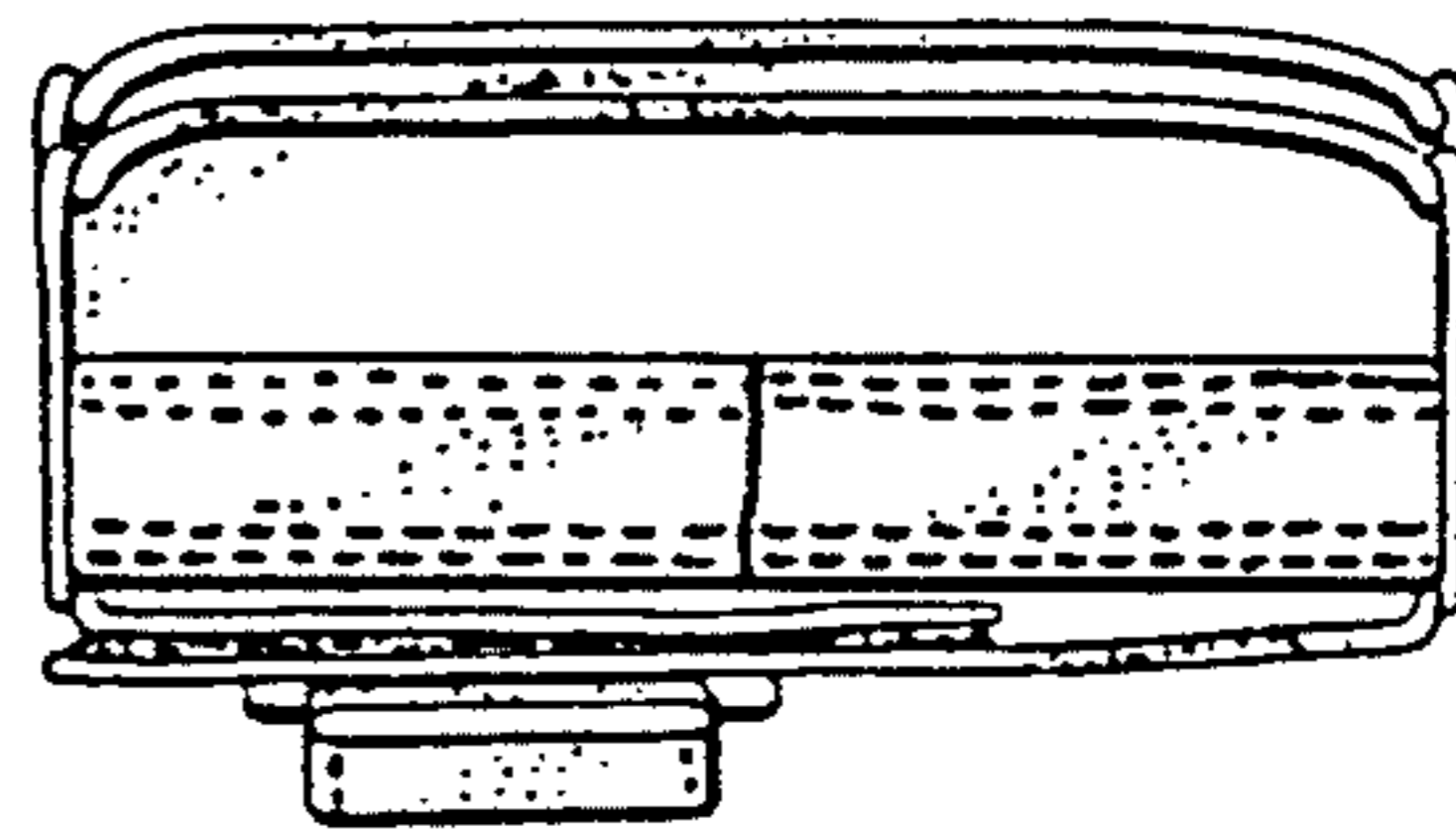
**FIG 4**



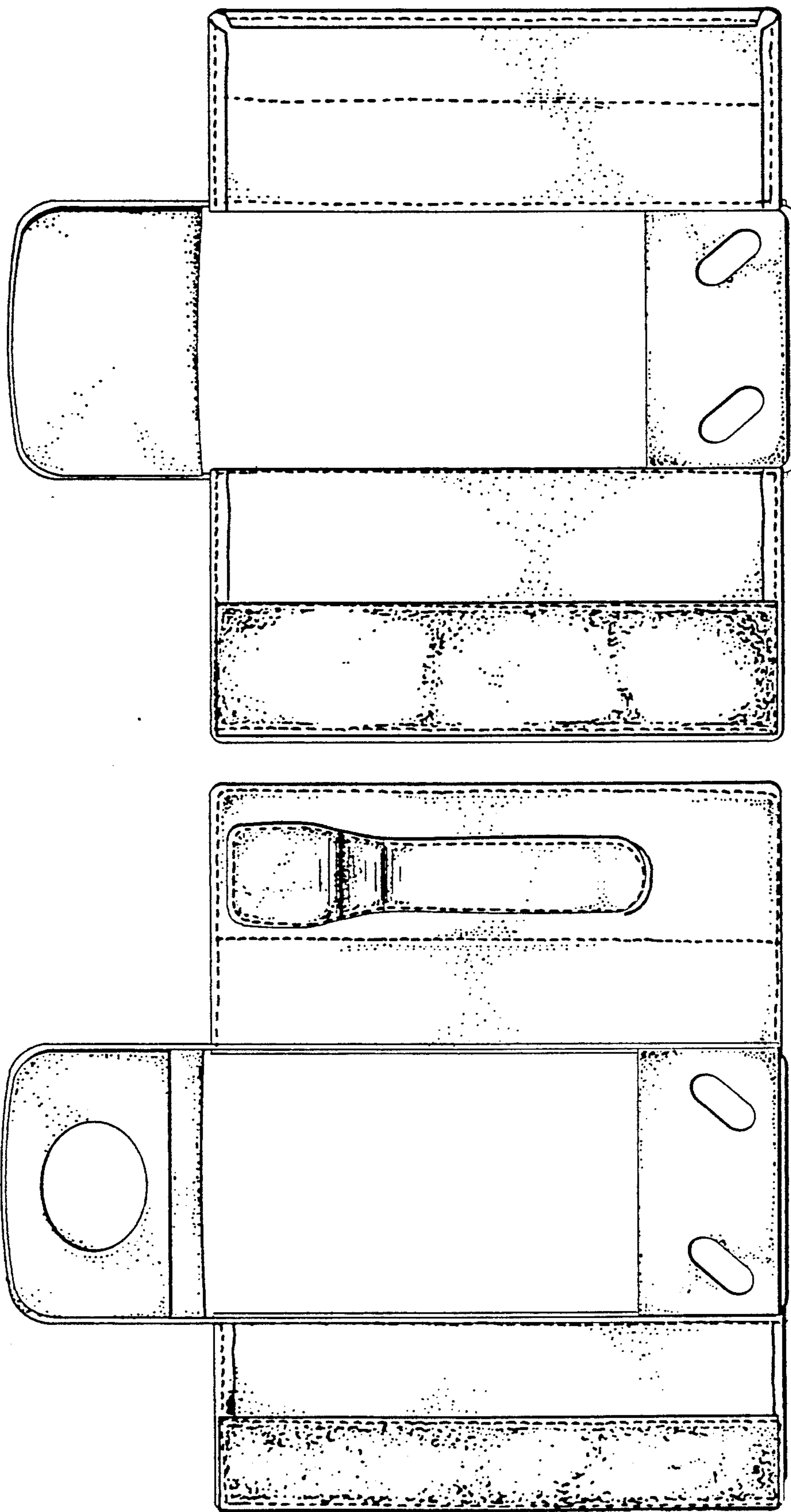
**FIG 5**



**FIG 6**

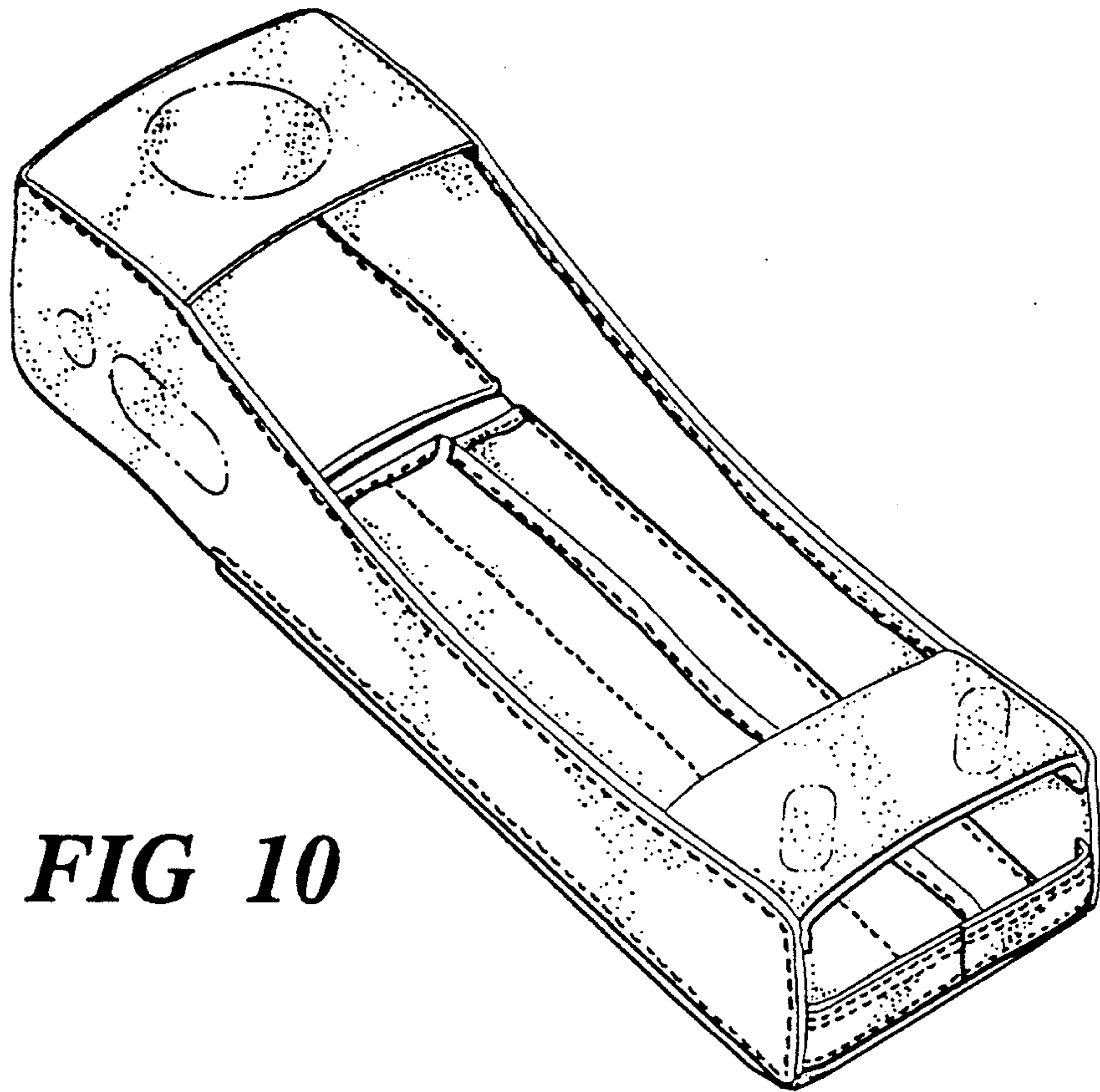


**FIG 7**

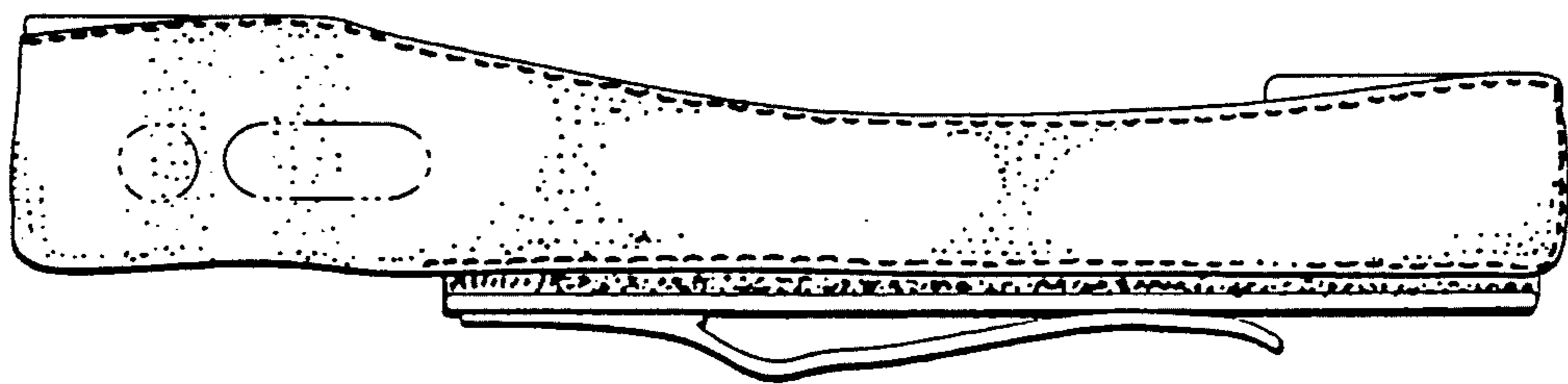


**FIG 9**

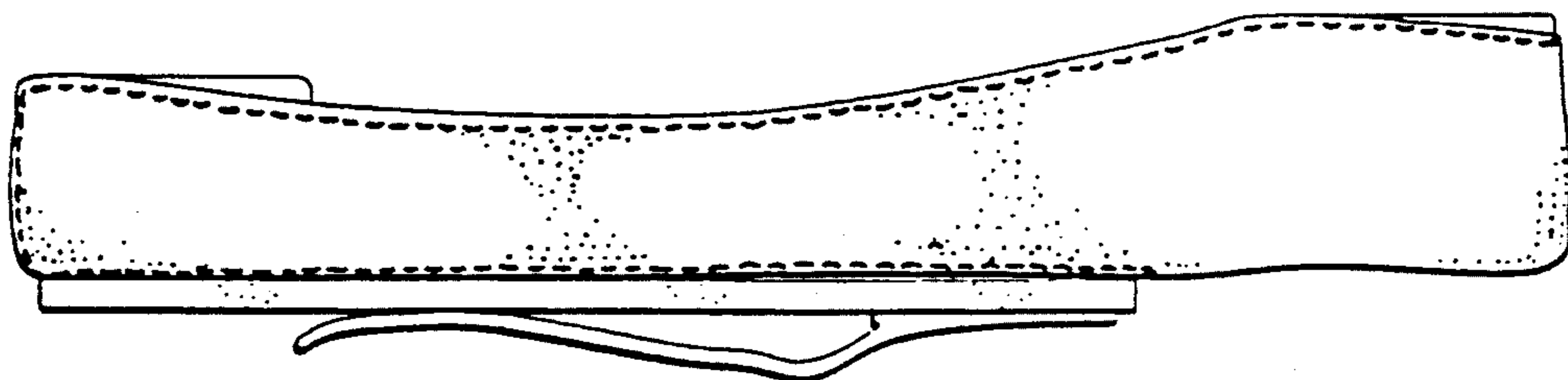
**FIG 8**



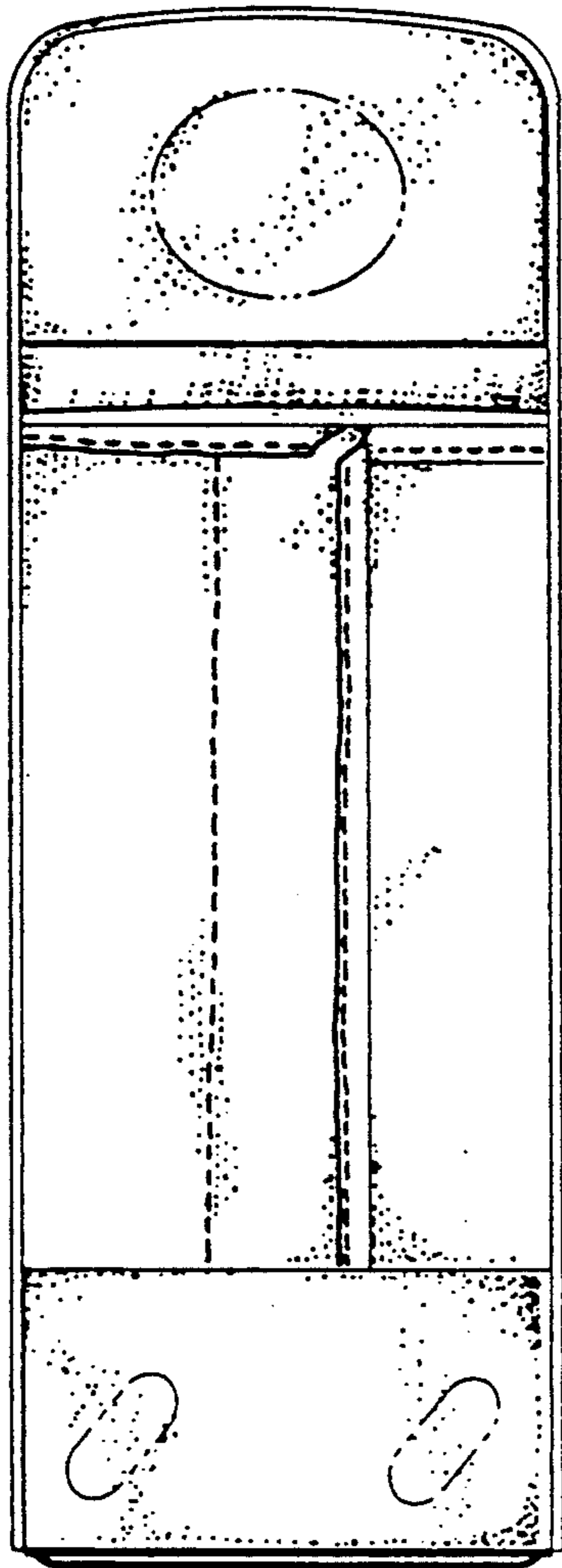
**FIG 10**



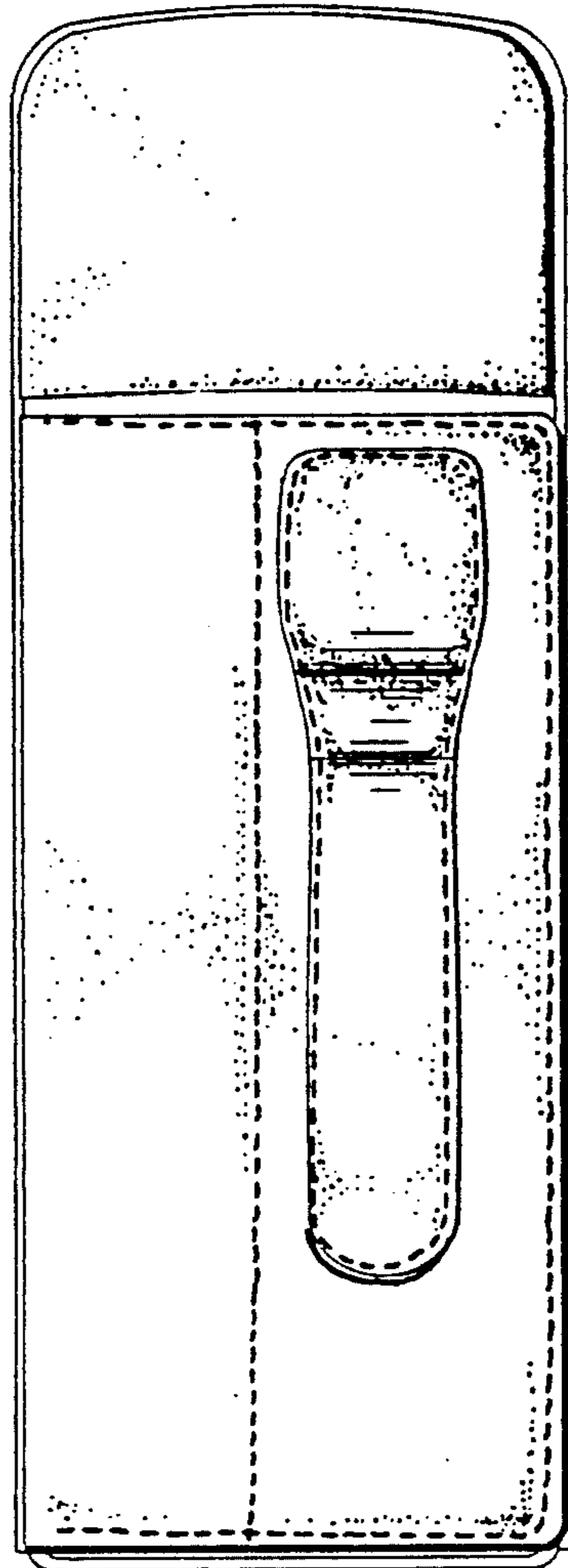
**FIG 11**



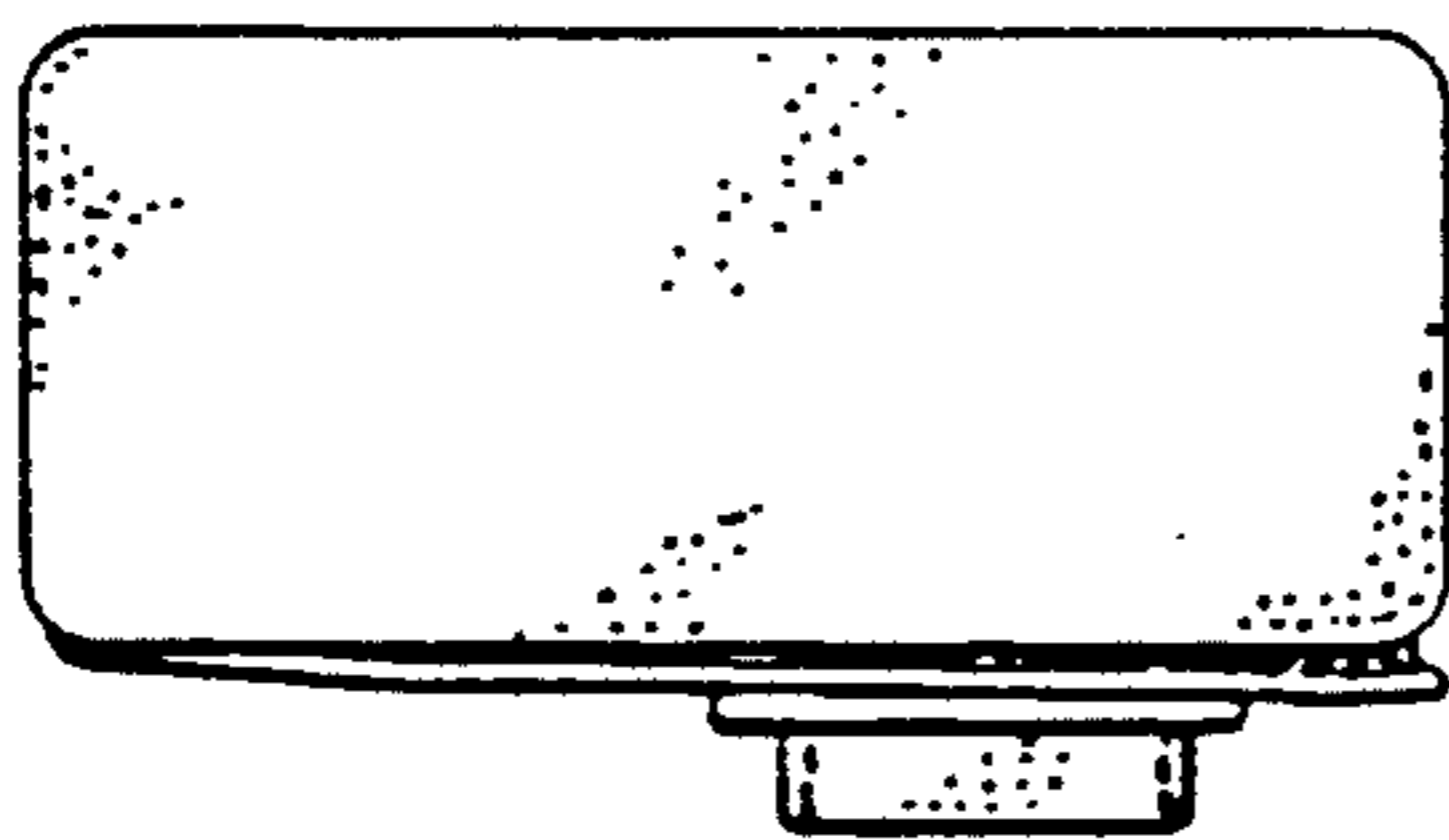
**FIG 12**



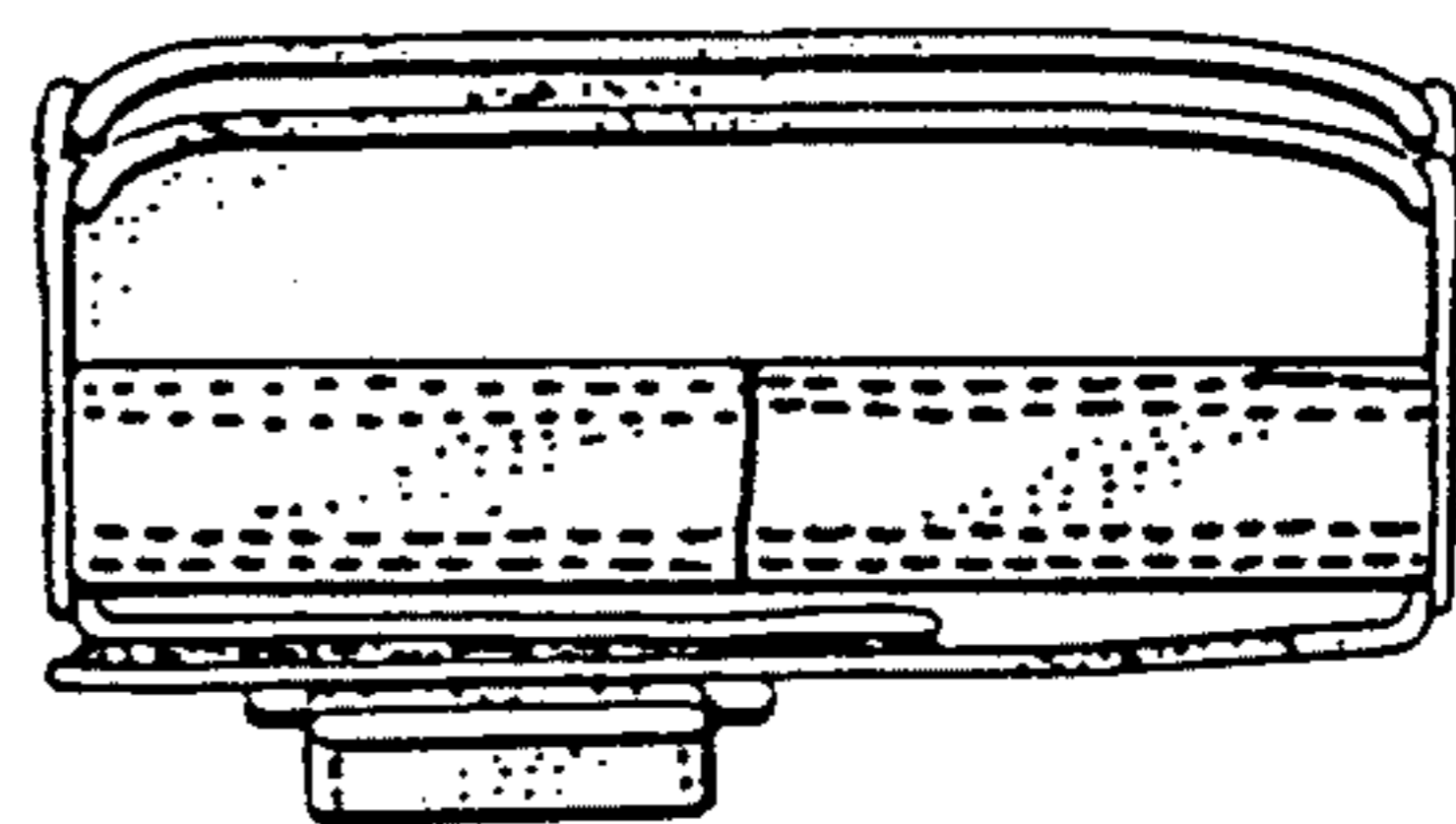
**FIG 13**



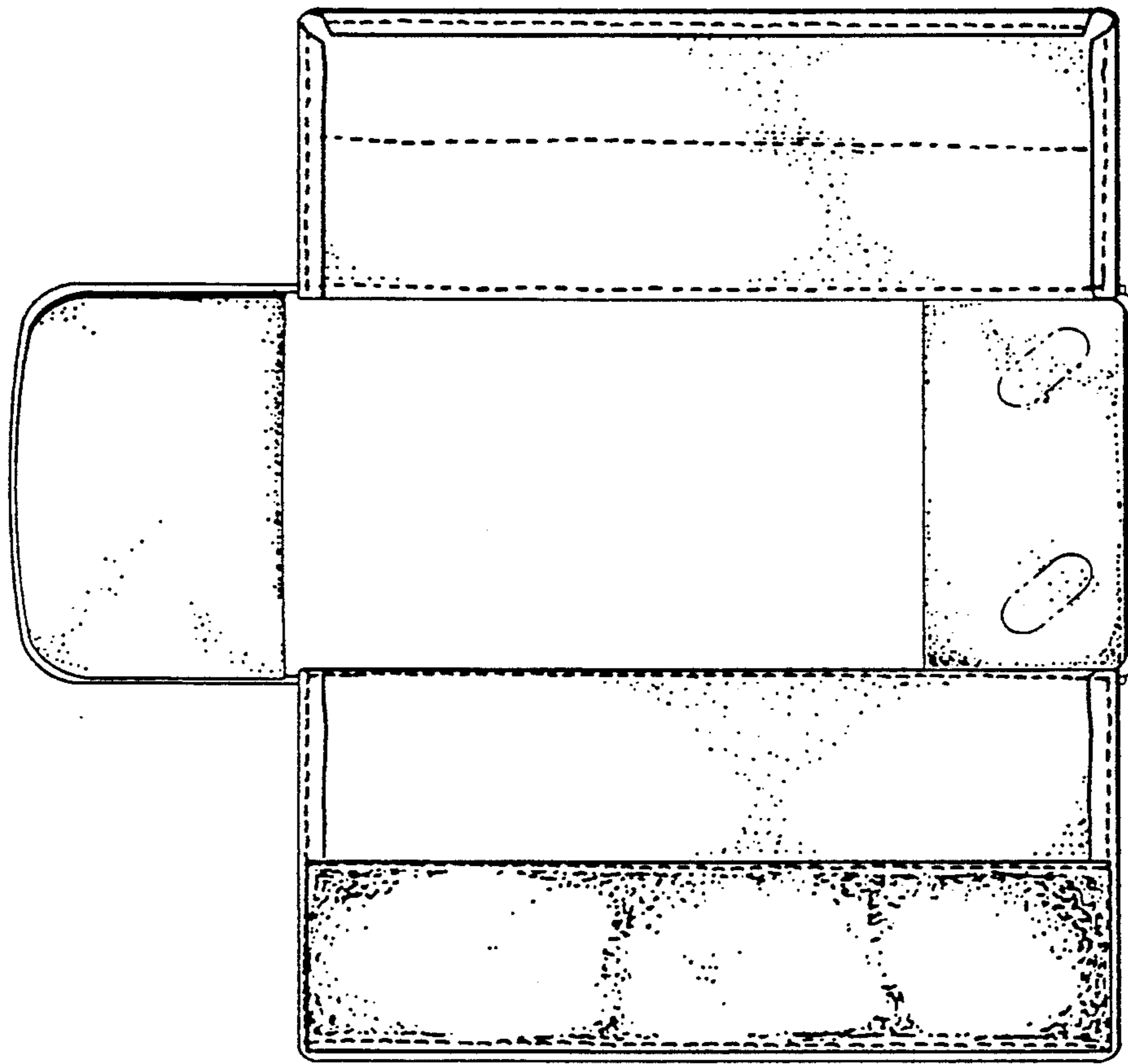
**FIG 14**



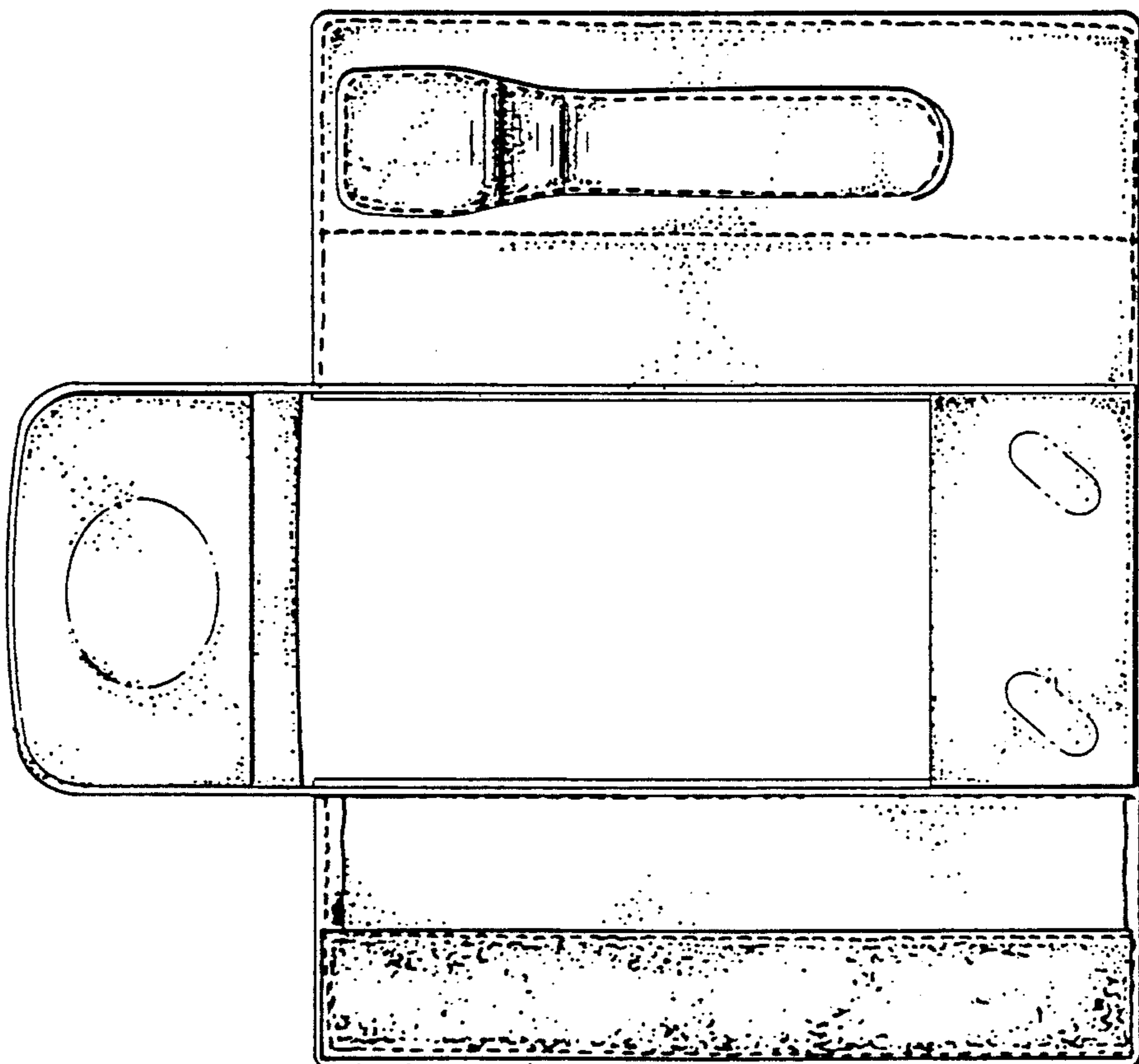
**FIG 15**



**FIG 16**

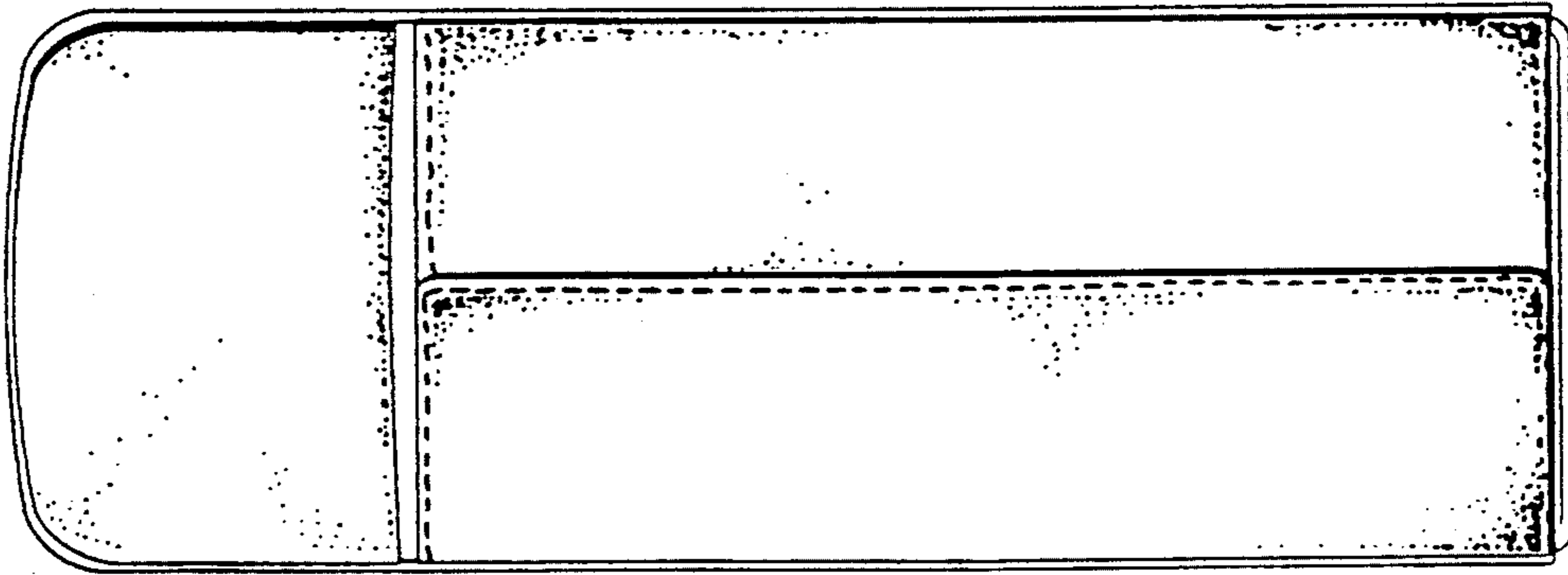


**FIG 18**

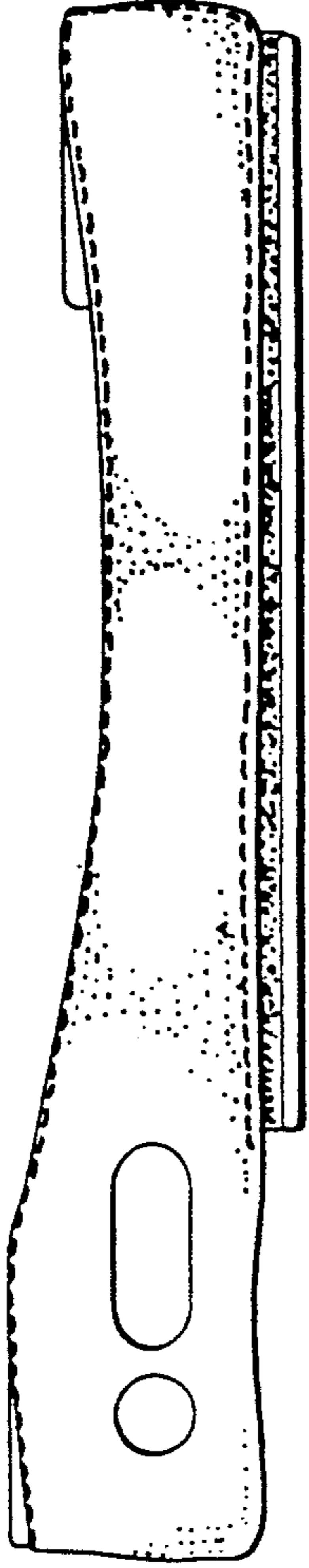


**FIG 17**

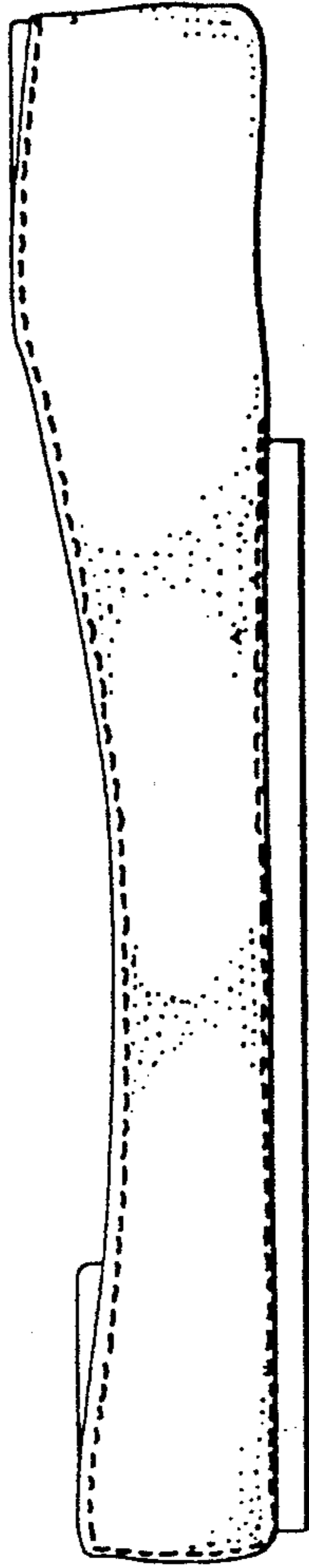




**FIG 19**



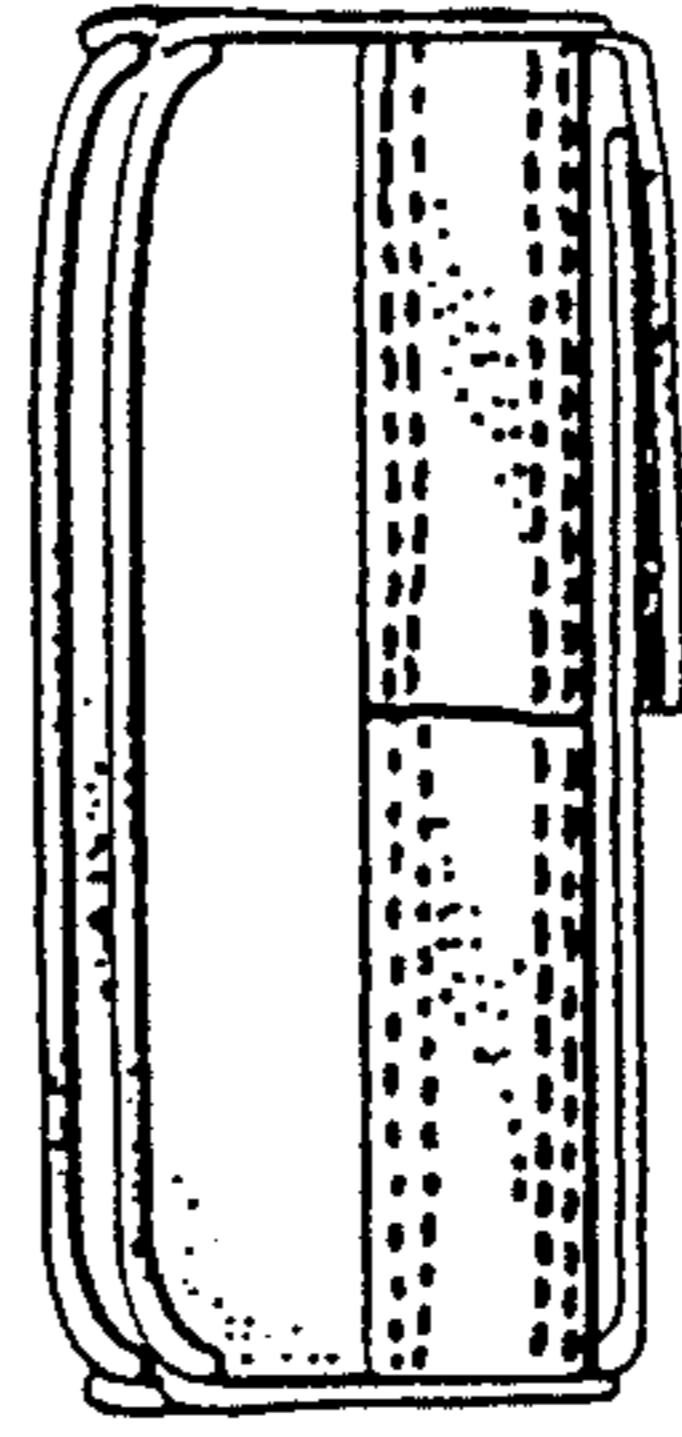
**FIG 20**



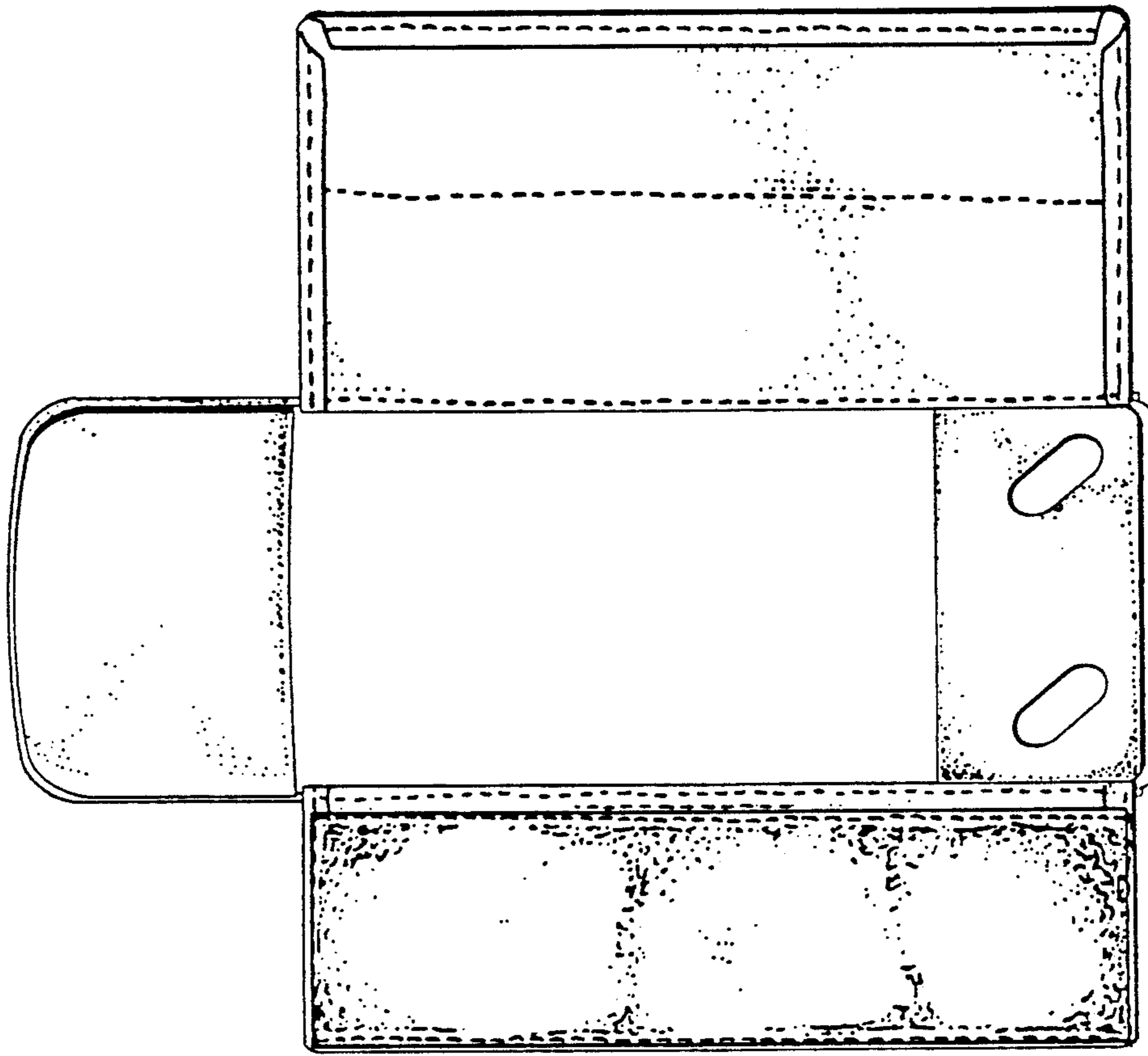
**FIG 21**



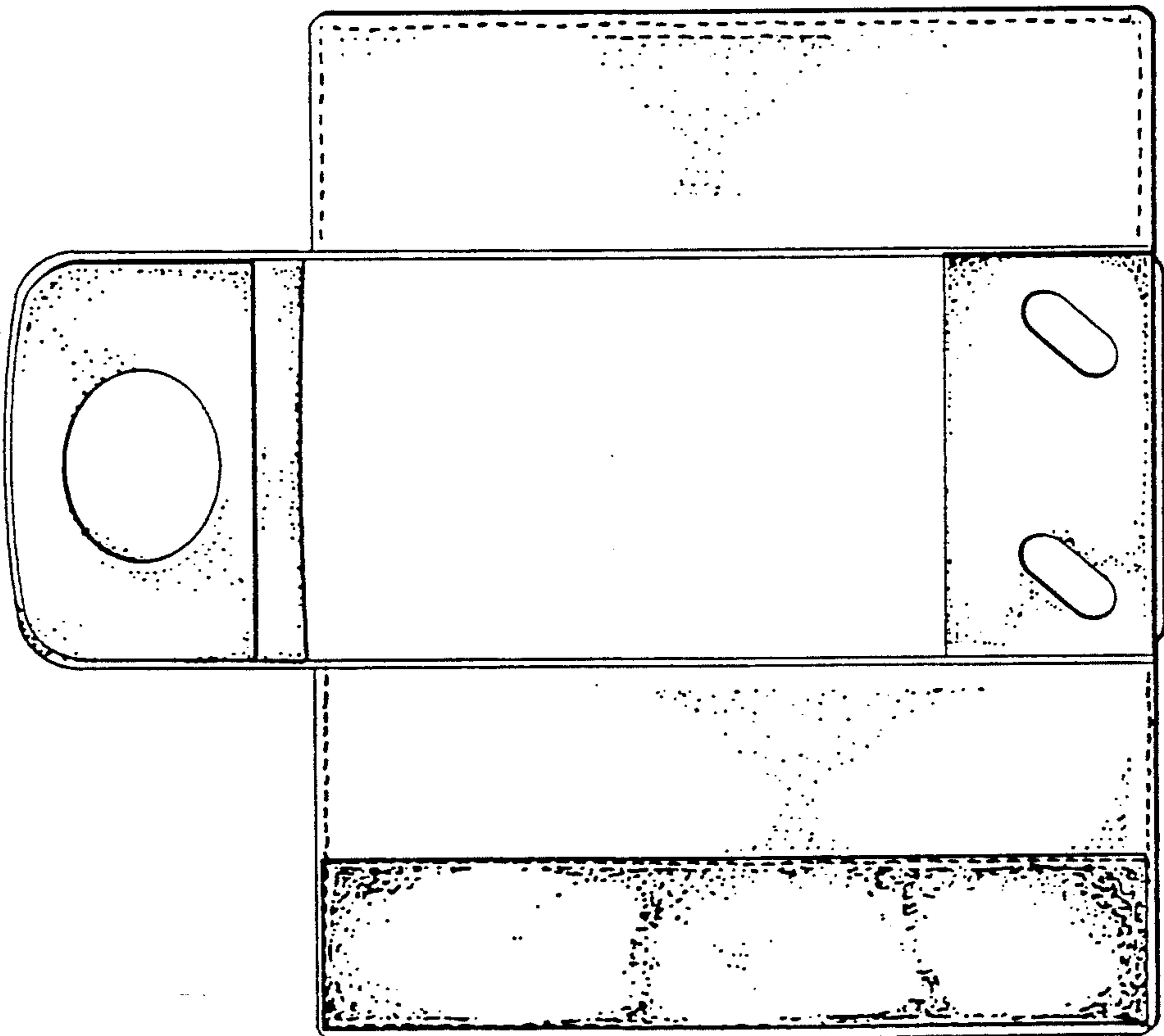
**FIG 22**



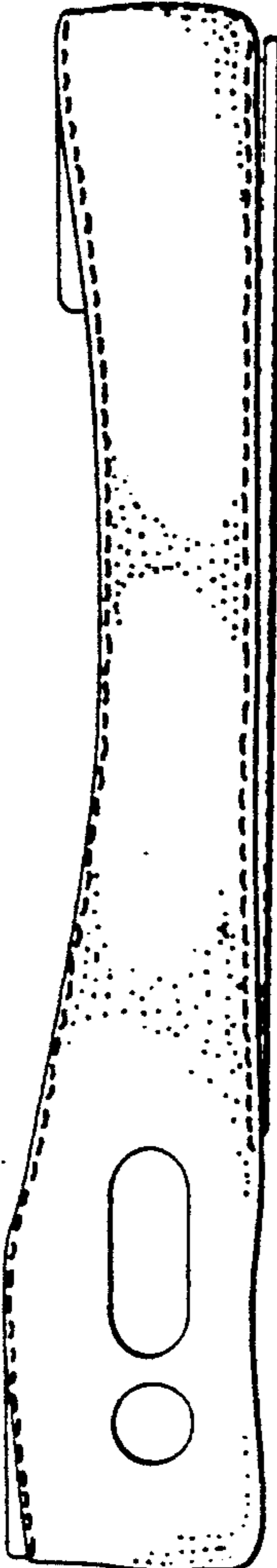
**FIG 23**



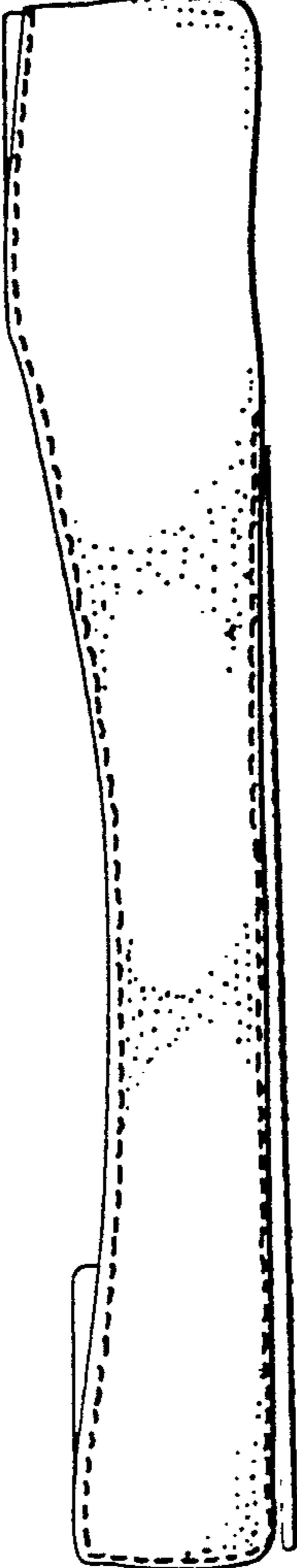
**FIG 25**



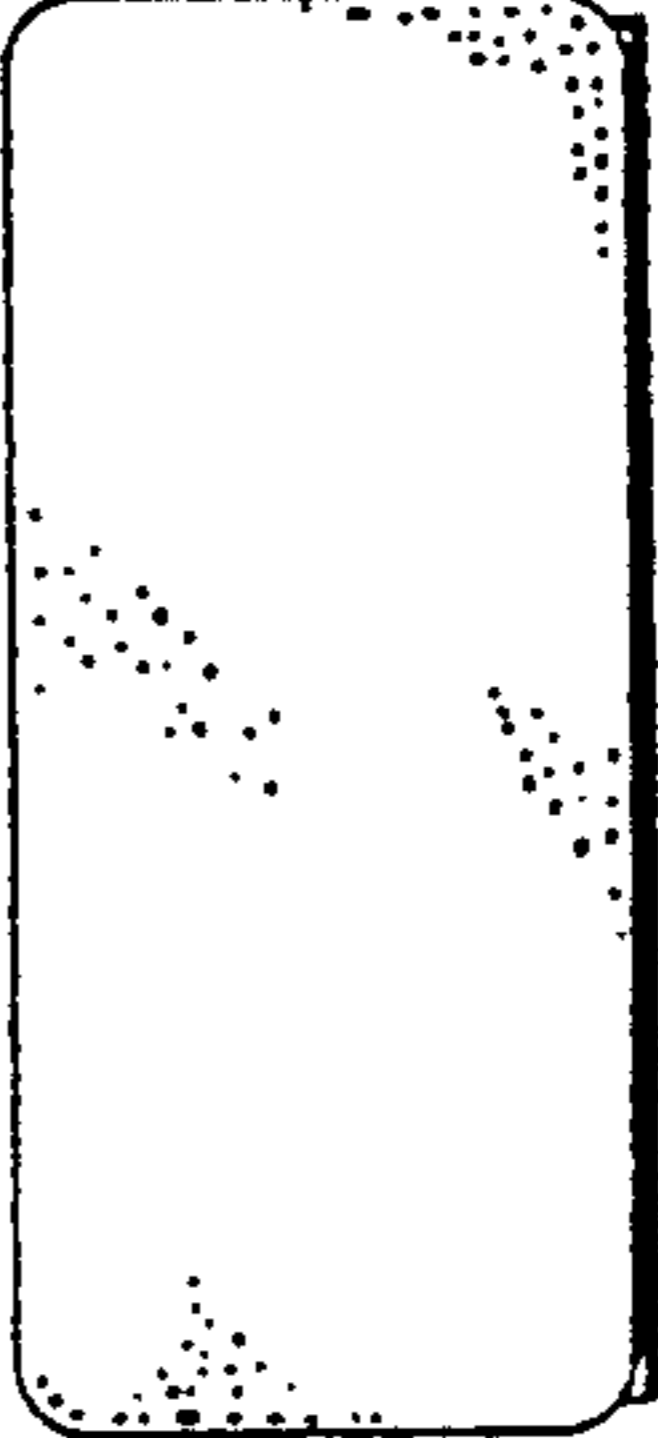
**FIG 24**



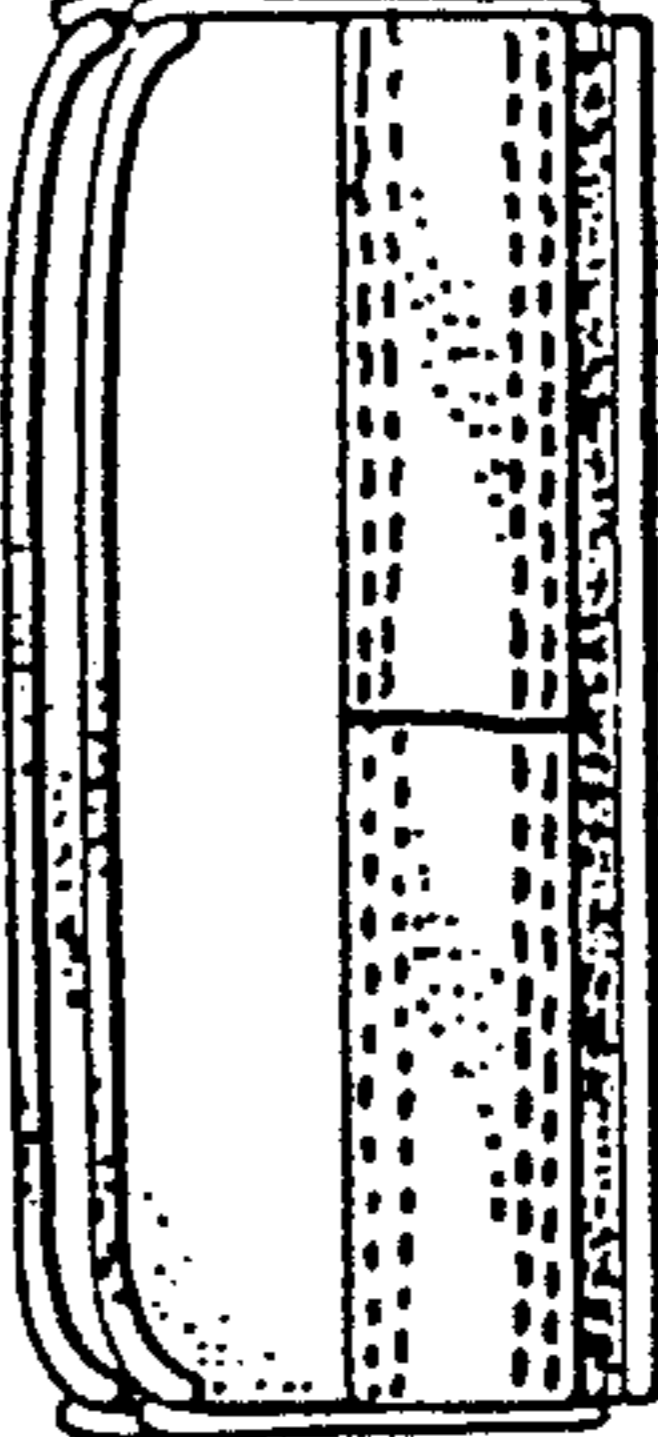
**FIG 27**



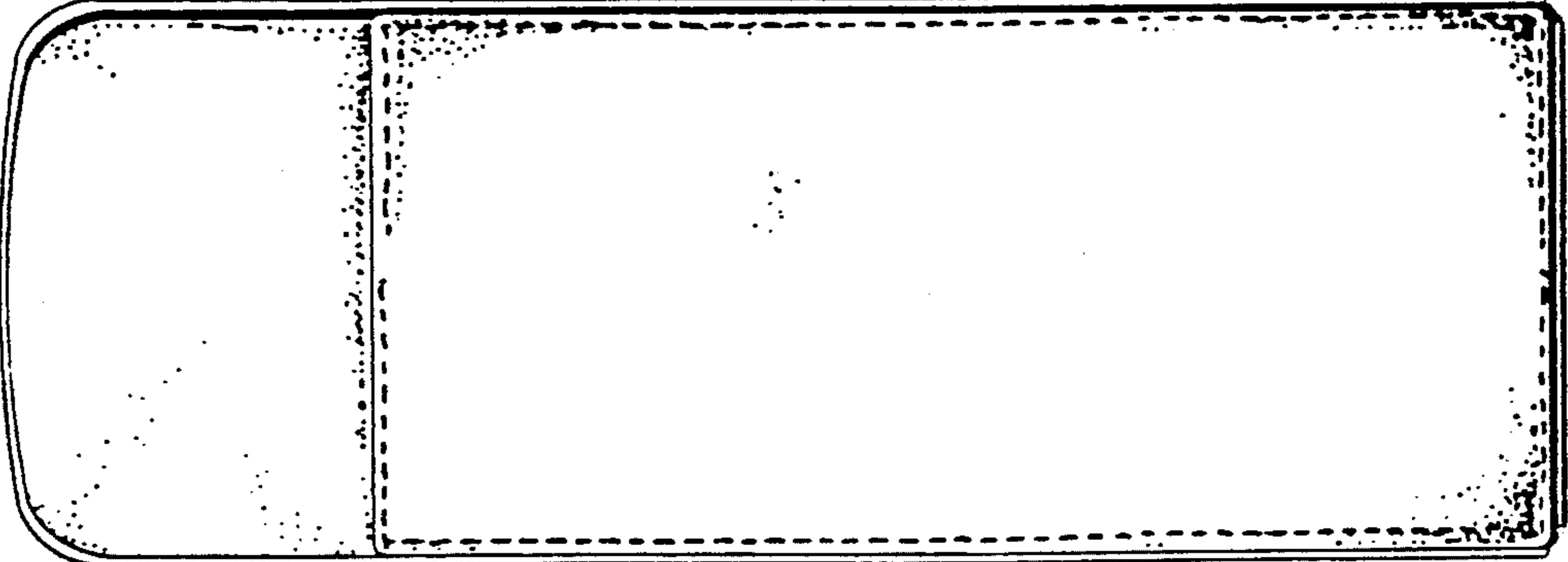
**FIG 28**



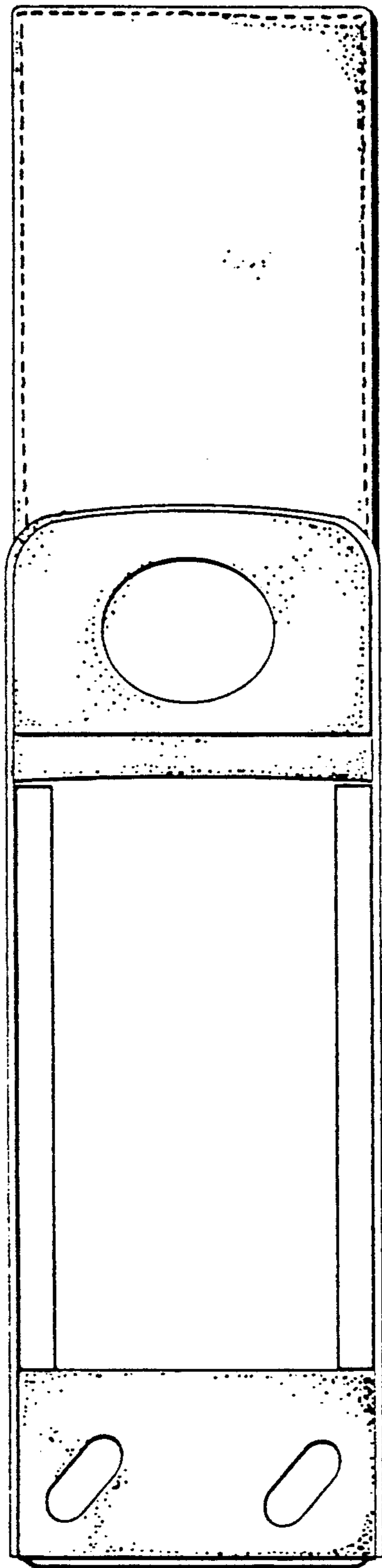
**FIG 29**



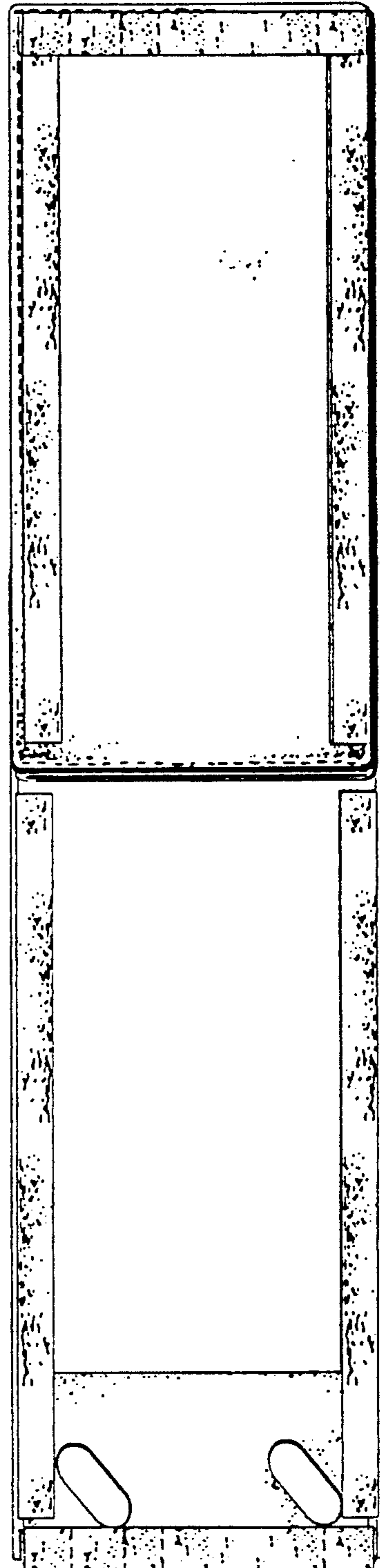
**FIG 30**



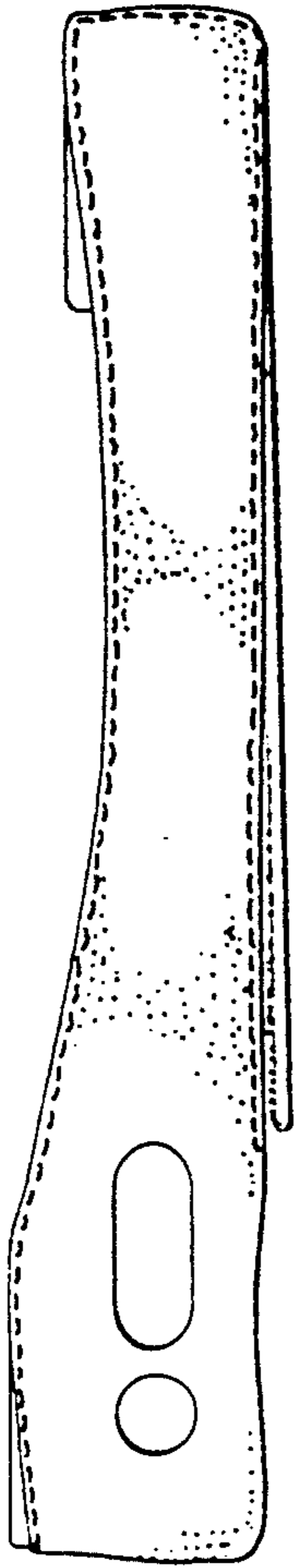
**FIG 26**



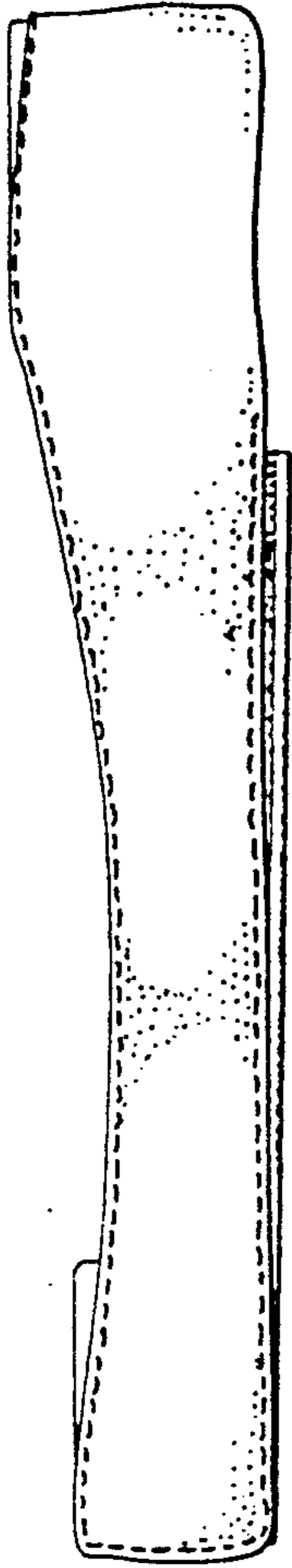
**FIG 31**



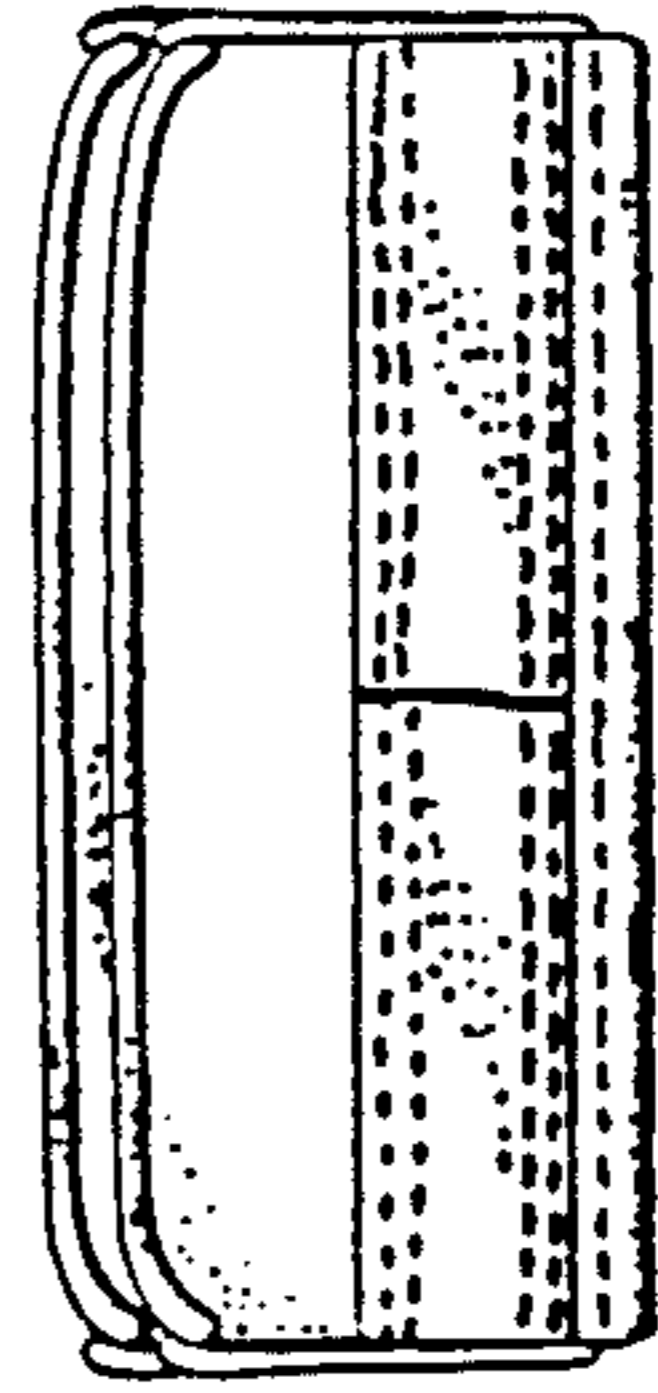
**FIG 32**



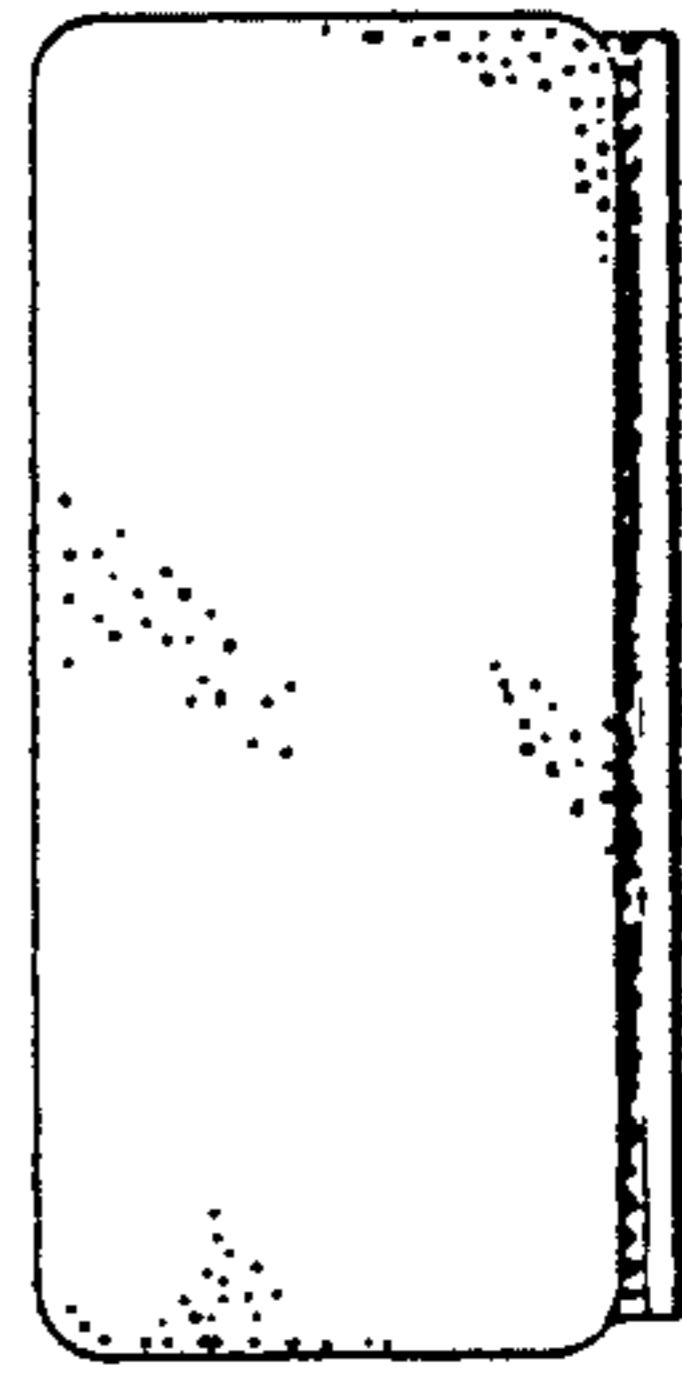
**FIG 34**



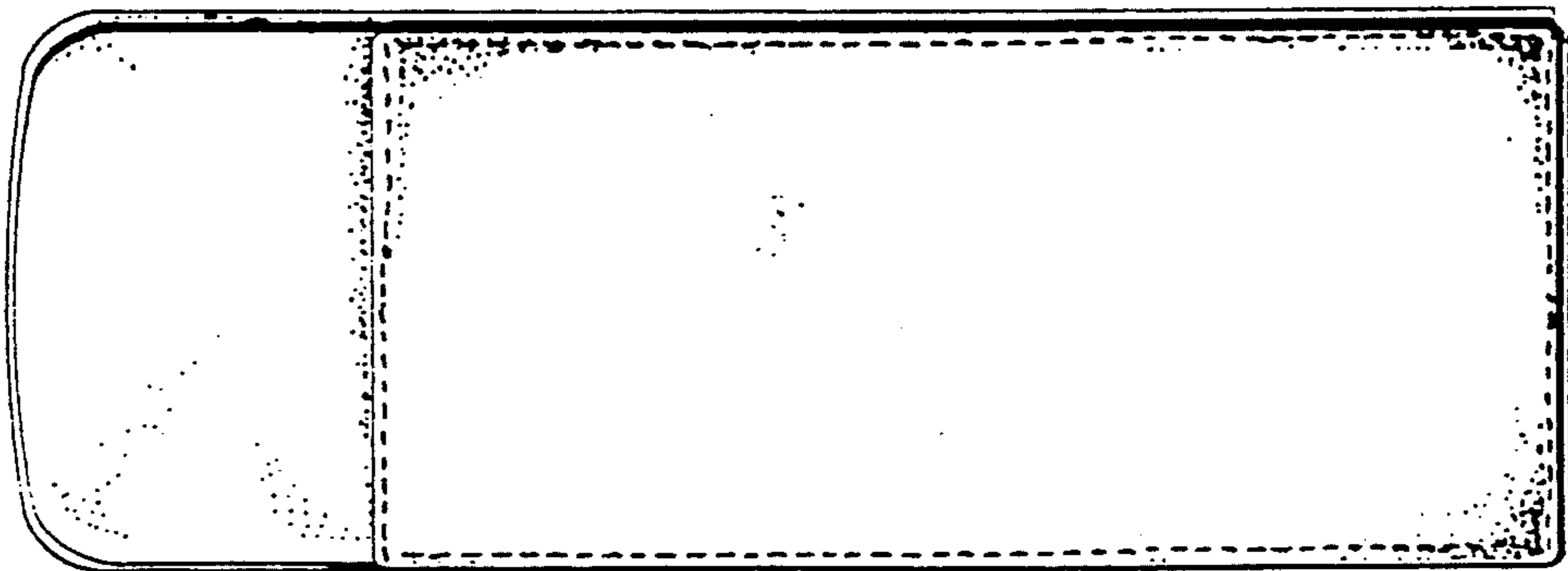
**FIG 35**



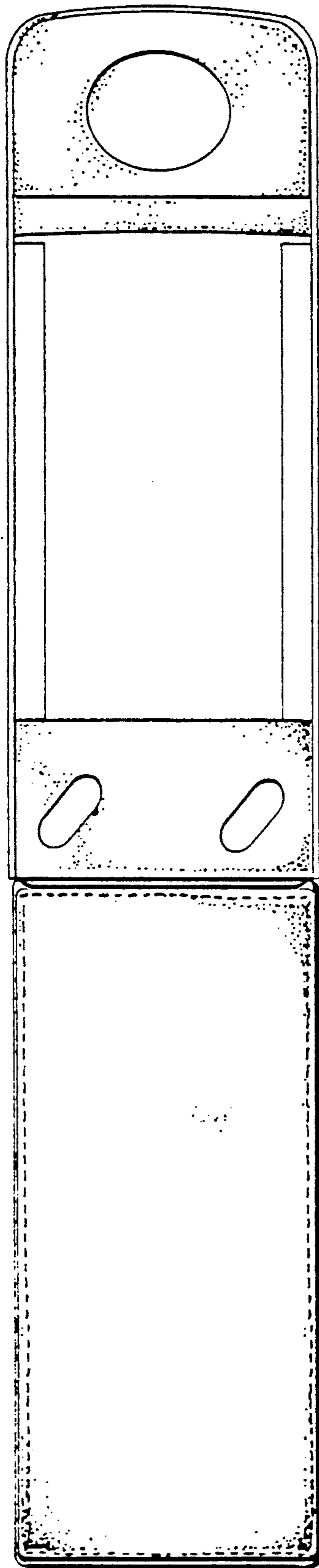
**FIG 37**



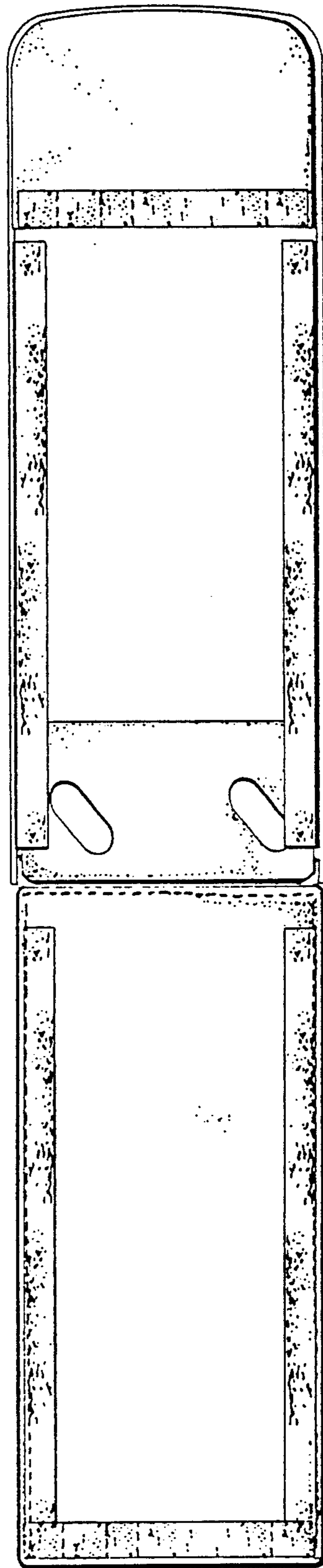
**FIG 36**



**FIG 33**



**FIG 38**



**FIG 39**