



US00D346476S

United States Patent [19]

[11] Patent Number: **Des. 346,476**

Kestekides-Kesdekoglu

[45] Date of Patent: **** May 3, 1994**

[54] **PIECE OF CHOCOLATE CANDY**

2,096,507 10/1937 Czeszczick, Jr. 426/104 X
4,001,440 1/1977 Hoyt 426/87 X

[75] Inventor: **Maria Kestekides-Kesdekoglu,**
Brussels, Belgium

Primary Examiner—Susan J. Lucas
Assistant Examiner—Pamela Burgess
Attorney, Agent, or Firm—Jacobson, Price, Holman & Stern

[73] Assignee: **S.A. Confiserie Leonidas,** Brussels, Belgium

[**] Term: **14 Years**

[57] **CLAIM**

[21] Appl. No.: **7,857**

The ornamental design for a piece of chocolate candy, as shown and described.

[22] Filed: **May 5, 1993**

DESCRIPTION

[30] **Foreign Application Priority Data**

Nov. 19, 1992 [XH] Hague DM/024470

[52] U.S. Cl. **D1/108**

[58] Field of Search D1/106, 108, 109;
426/104; D21/166

FIG. 1 is a perspective view of a piece of chocolate candy according to my invention;
FIG. 2 is another perspective view thereof;
FIG. 3 is a top plan view;
FIG. 4 is a bottom plan view thereof;
FIG. 5 is a left side view thereof;
FIG. 6 is a right side view thereof;
FIG. 7 is an end view thereof; and,
FIG. 8 is an end view opposite to the view of FIG. 7.

[56] **References Cited**

U.S. PATENT DOCUMENTS

D. 24,364 6/1895 Keller D1/109

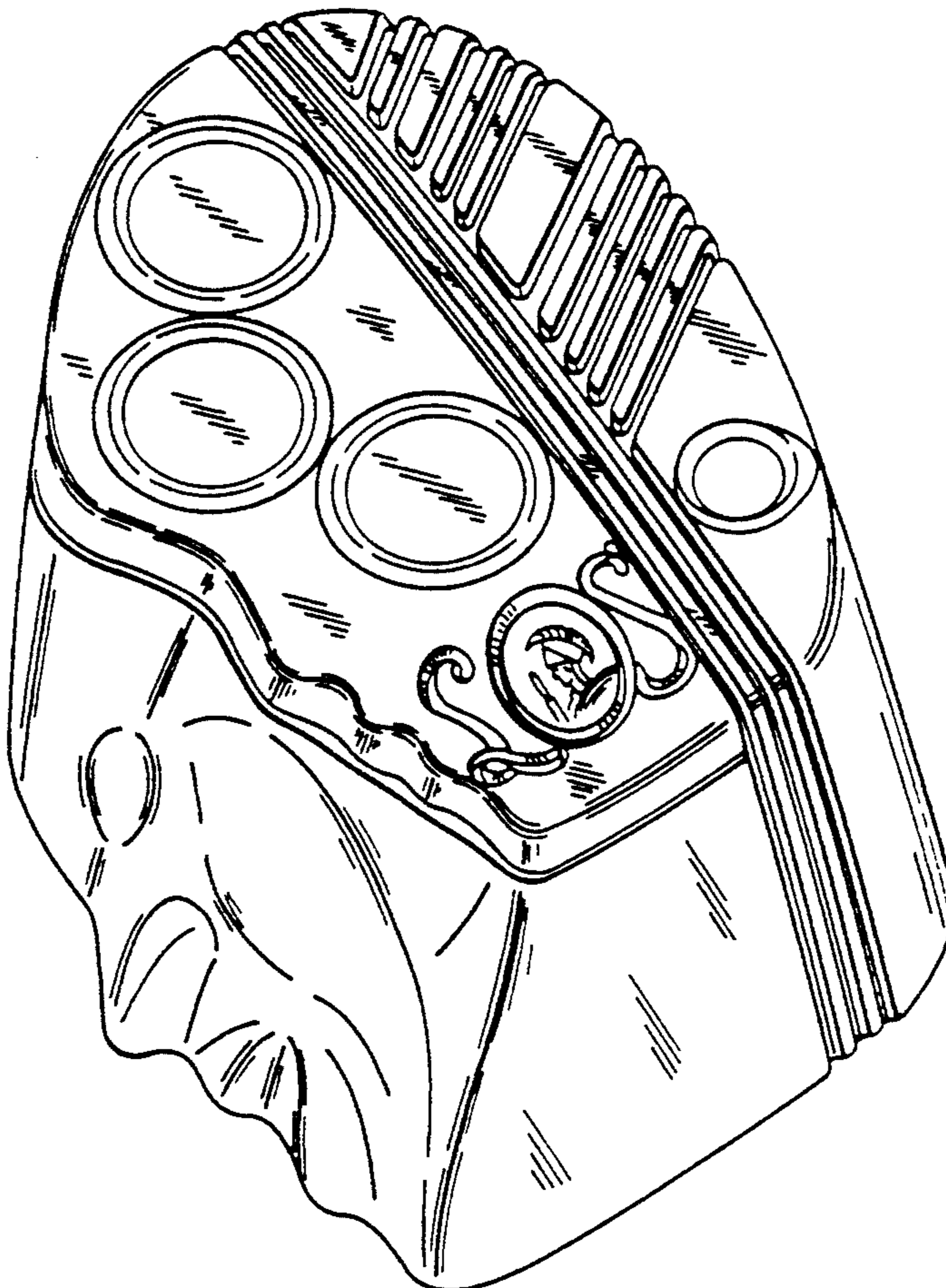

Fig. 1

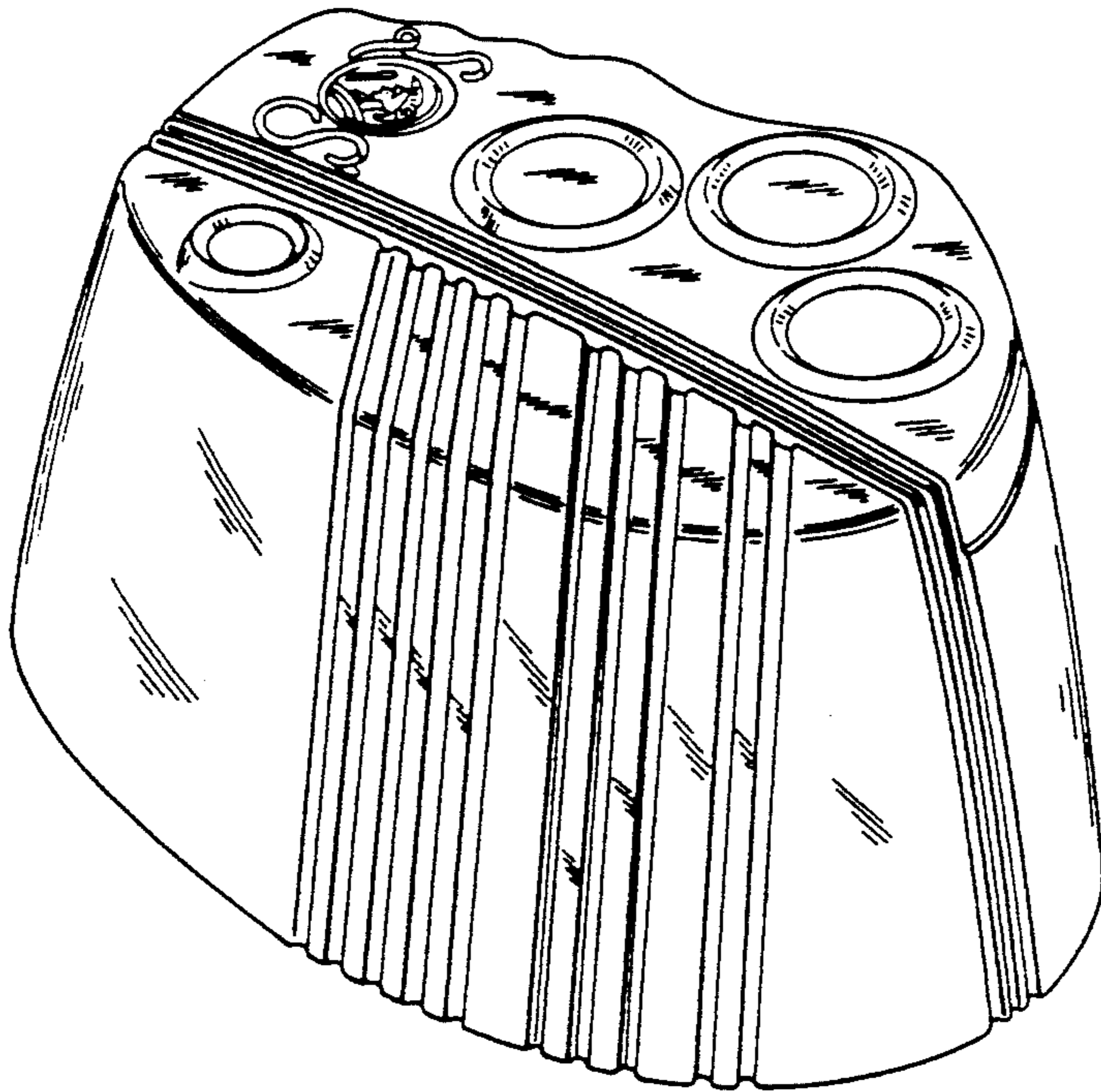
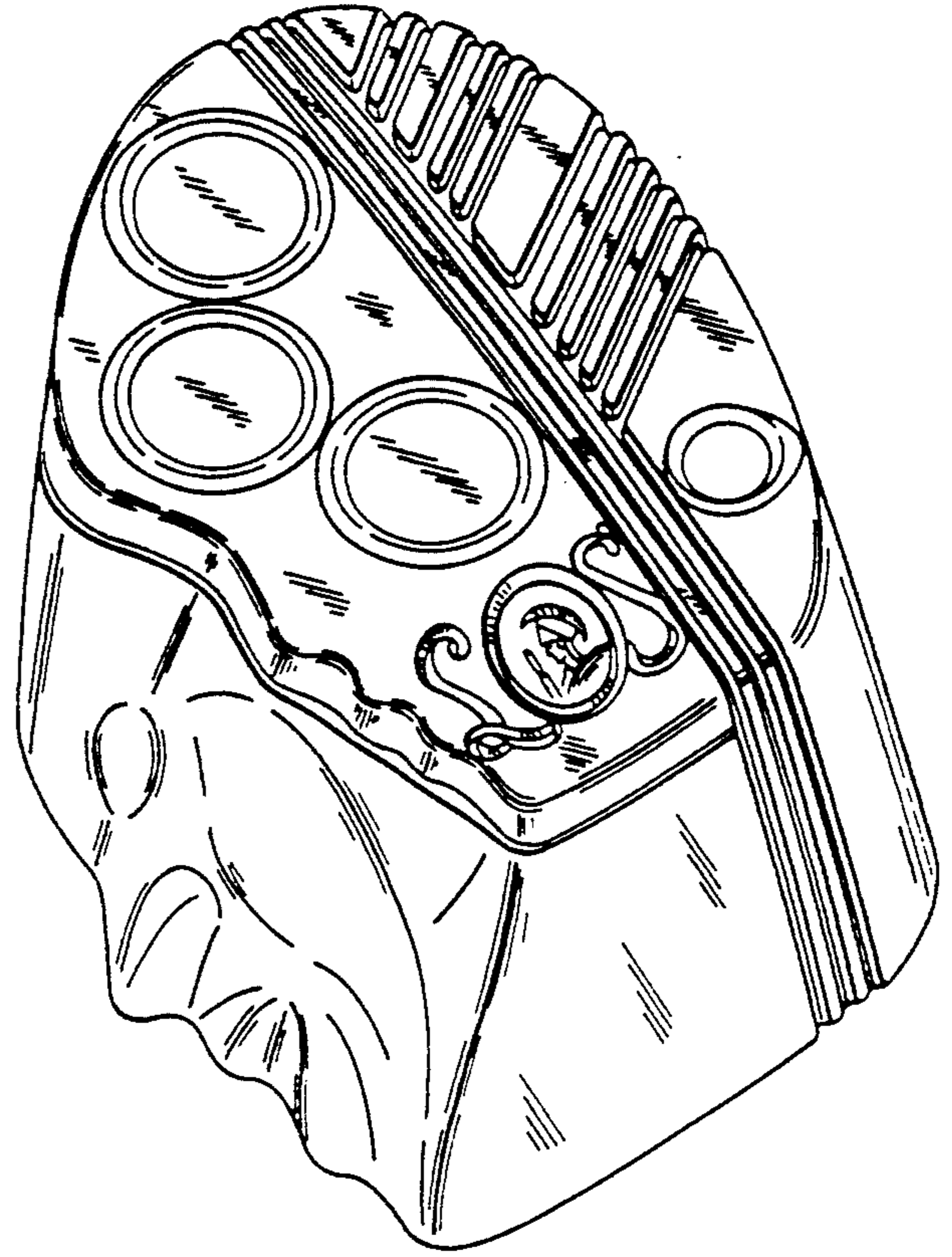

Fig. 2

Fig. 3

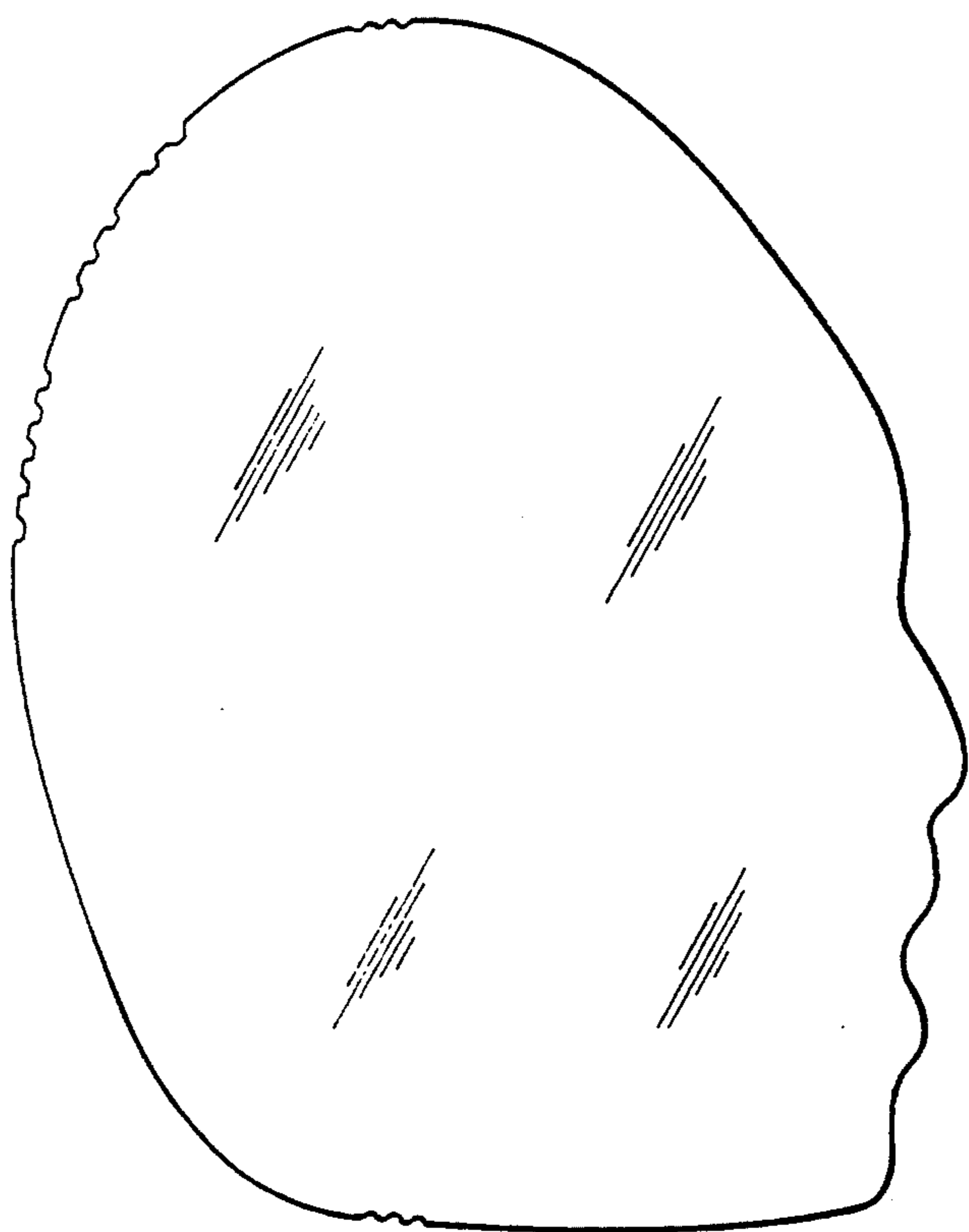
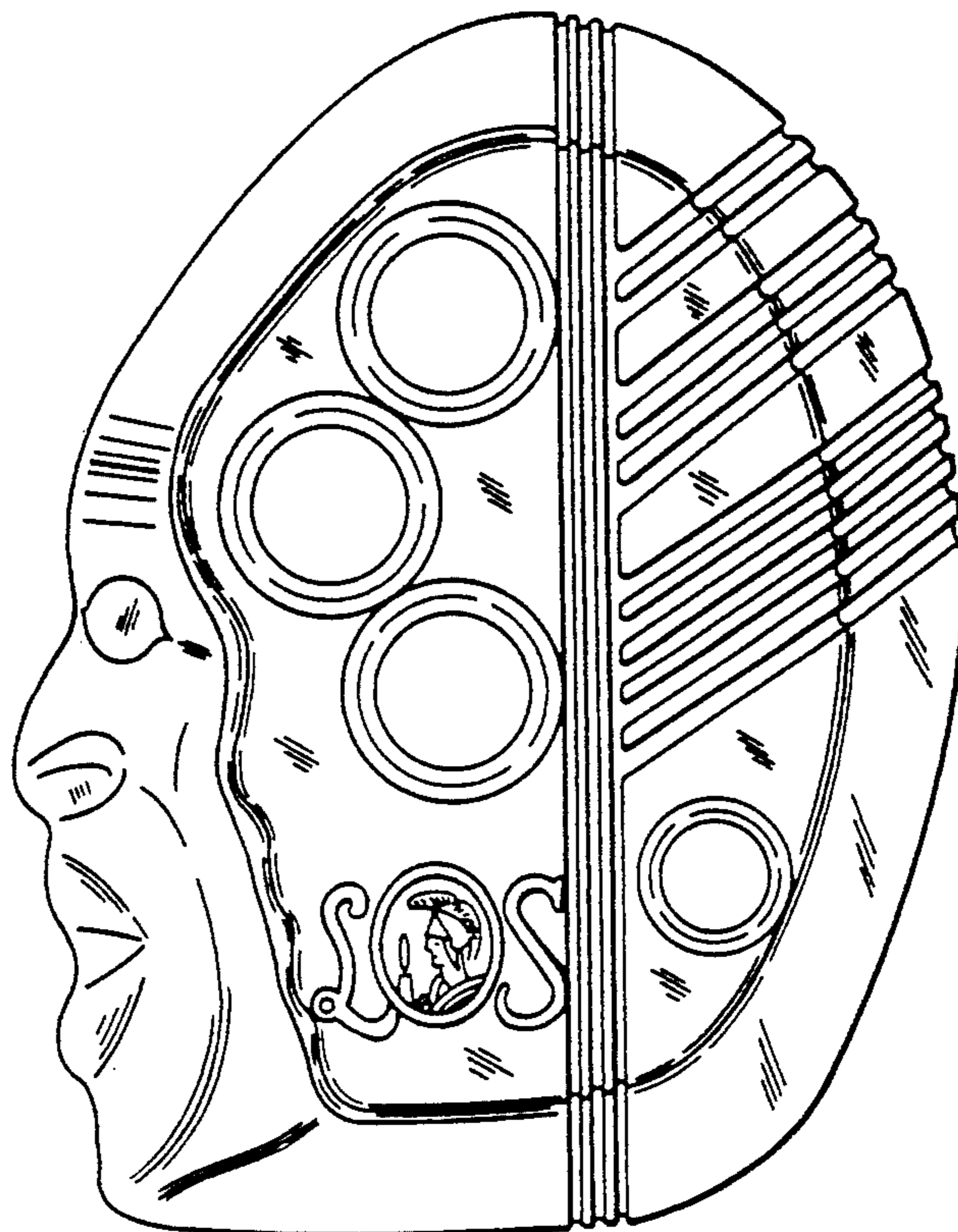

Fig. 4

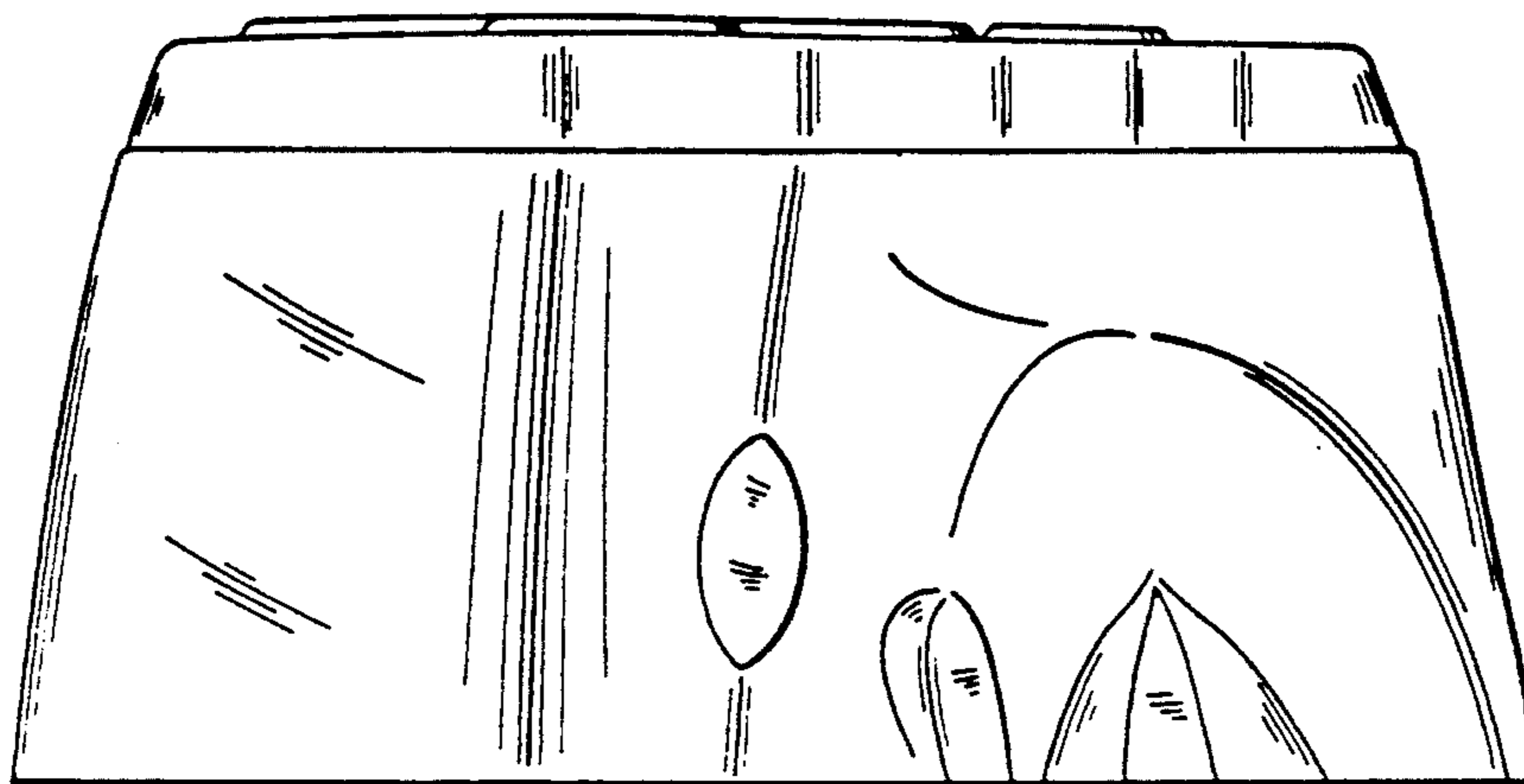

Fig. 5

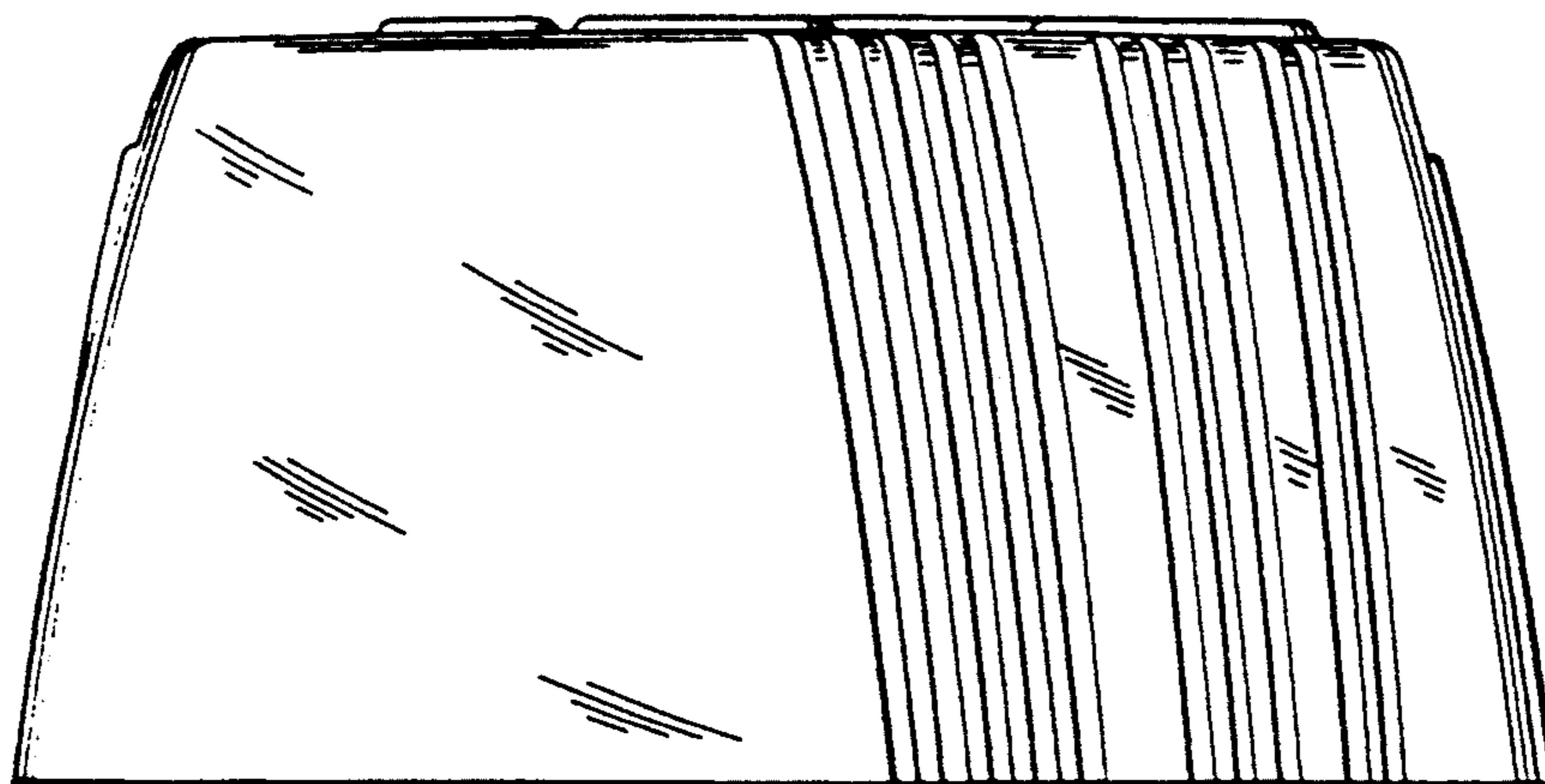

Fig. 6

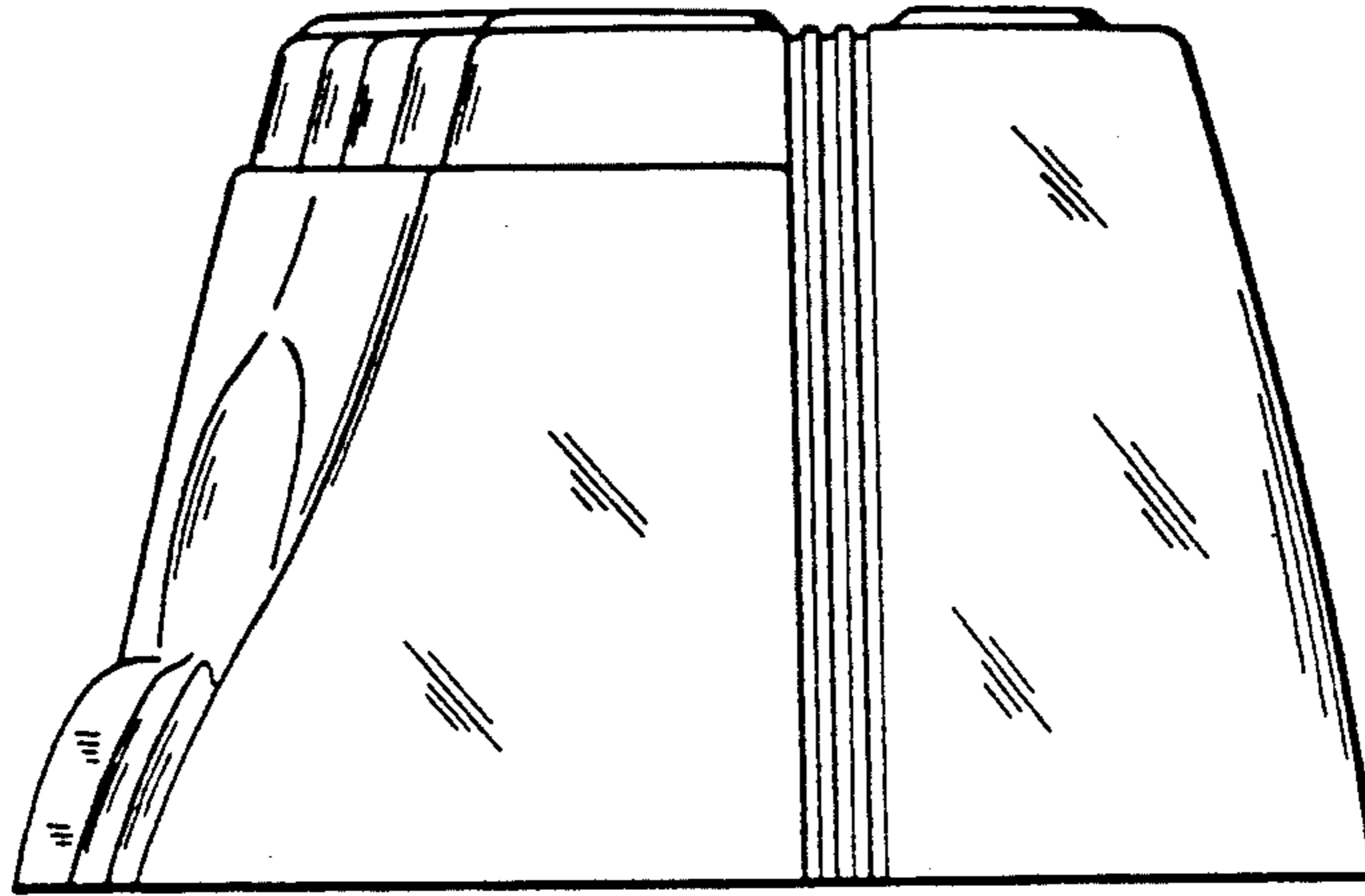

Fig. 7

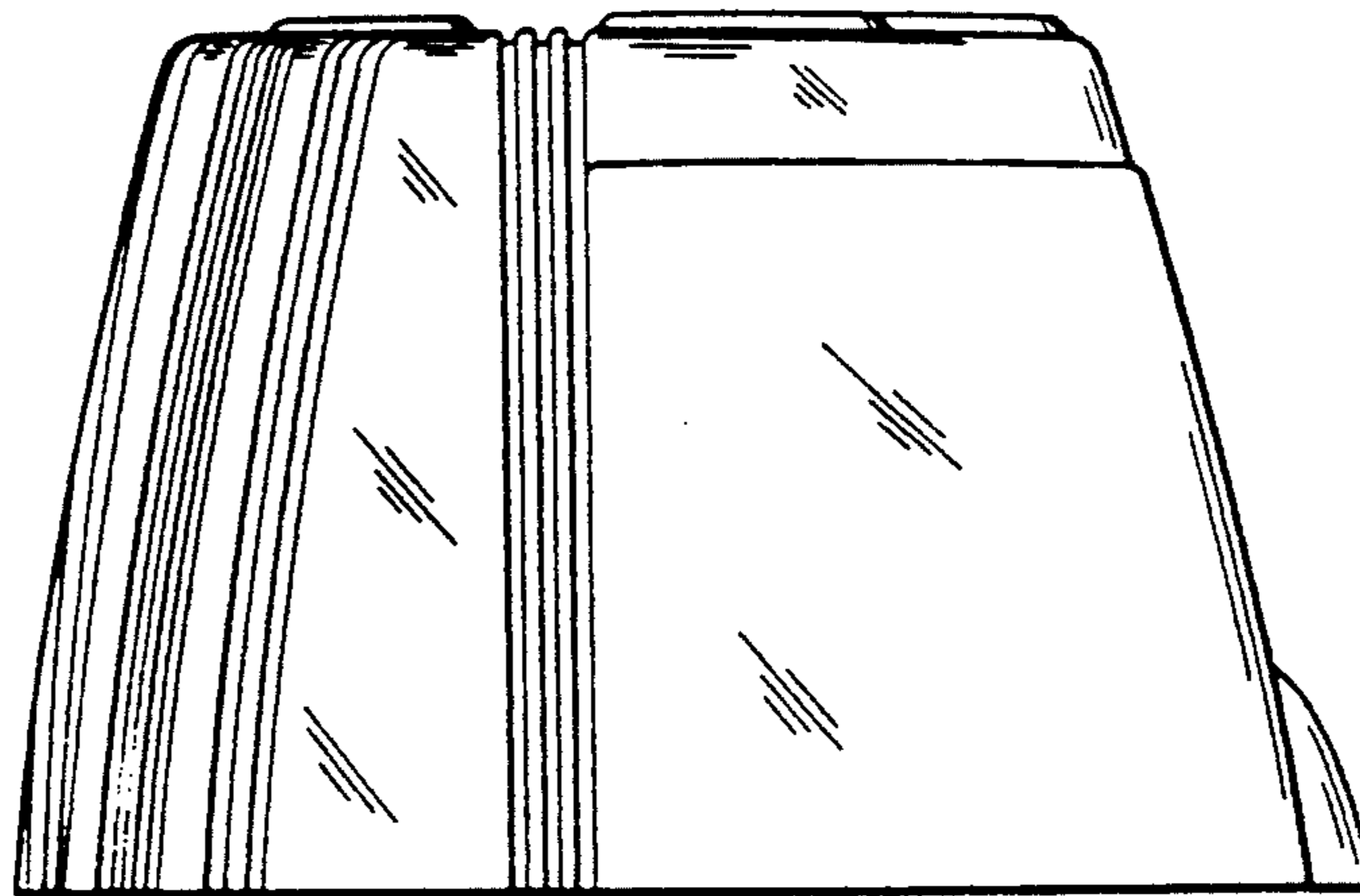

Fig. 8

UNITED STATES PATENT AND TRADEMARK OFFICE
CERTIFICATE OF CORRECTION

PATENT NO. : D346,476

DATED : May 3, 1994

INVENTOR(S) : Maria KESTEKIDES-KESDEKOGLU

It is certified that error appears in the above-identified patent and that said Letters Patent is hereby corrected as shown below:

On the title page, left column at [30], "Nov. 19, 1992
[XH] Hague DM/024470" should read --Nov. 19, 1992
[XH] WIPO DM/024470--.

Signed and Sealed this
Tenth Day of June, 1997

Attest:



BRUCE LEHMAN

Attesting Officer

Commissioner of Patents and Trademarks