



US00D346463S

United States Patent [19]

[11] Patent Number: **Des. 346,463**

Nakashima et al.

[45] Date of Patent: **** Apr. 26, 1994**

[54] **ELECTRIC HAIR CLIPPER**

[56]

References Cited

U.S. PATENT DOCUMENTS

[75] Inventors: **Yoshiyuki Nakashima; Shinji Yamamoto**, both of Osaka, Japan;
Florian Seiffert, Lanzasstrasse, Fed. Rep. of Germany

D. 283,061 3/1986 Kitashima et al. D28/53
D. 304,627 11/1989 Yonesawa D28/53
D. 306,917 3/1990 Terasawa et al. D28/53
D. 320,673 10/1991 Sterk D28/52

[73] Assignee: **Matsushita Electric Works, Ltd.**, Osaka, Japan

Primary Examiner—Bernard Ansher
Assistant Examiner—C. Tuttle
Attorney, Agent, or Firm—Leydig, Voit & Mayer

[**] Term: **14 Years**

[57] CLAIM

The ornamental design for an electric hair clipper, as shown and described.

[21] Appl. No.: **714,057**

DESCRIPTION

[22] Filed: **Jun. 12, 1991**

FIG. 1 is a front view of an electric hair clipper showing our new design;

[30] Foreign Application Priority Data

Dec. 18, 1990 [JP] Japan 2-42263
[52] U.S. Cl. **D28/53**
[58] Field of Search 30/30, 34.05, 34.1,
30/34.2, 85, 41, 41.9, 43, 43.3, 43.7, 42, 45, 200,
204, 208, 210; D28/44-53

FIG. 2 is a rear view thereof;

FIG. 3 is a right side elevational view thereof, the opposite side being a mirror image of this view;

FIG. 4 is a top plan view thereof;

FIG. 5 is a bottom plan view thereof;

FIG. 6 is a top front perspective view thereof; and,

FIG. 7 is a top rear perspective view thereof.

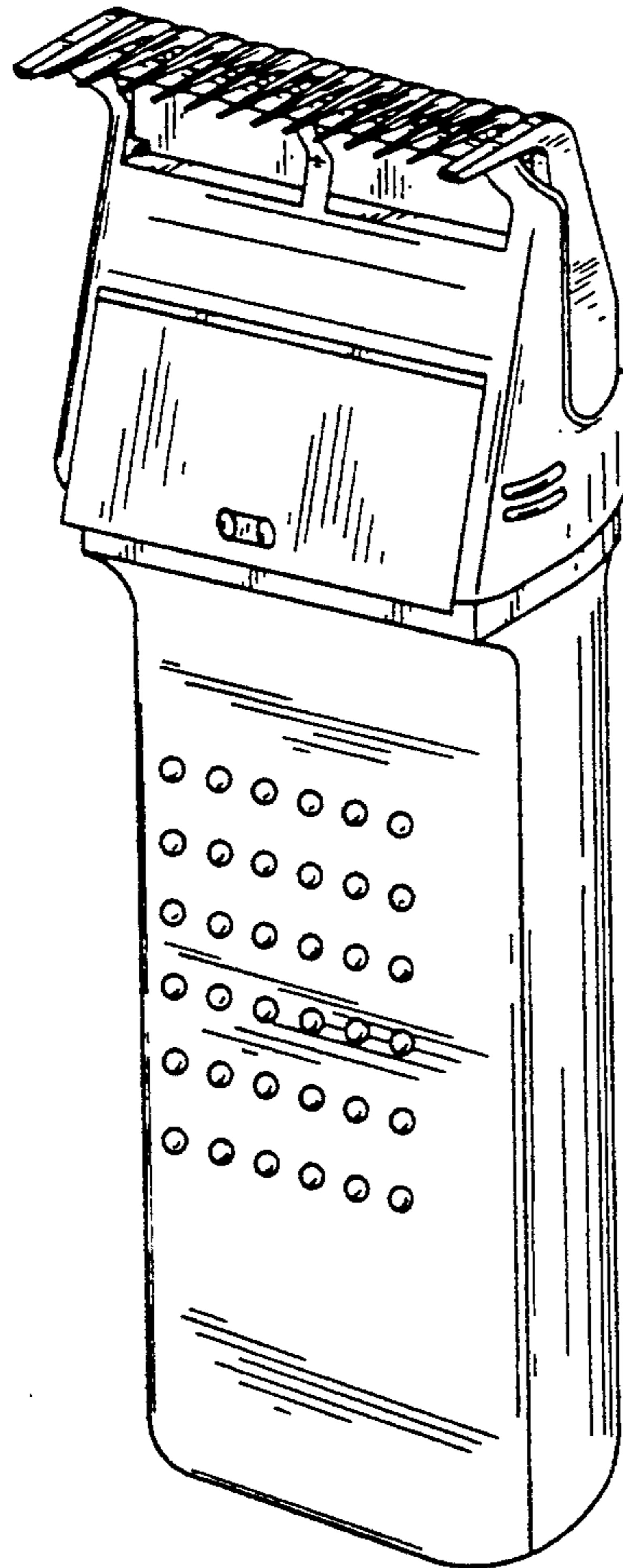

Fig. 1

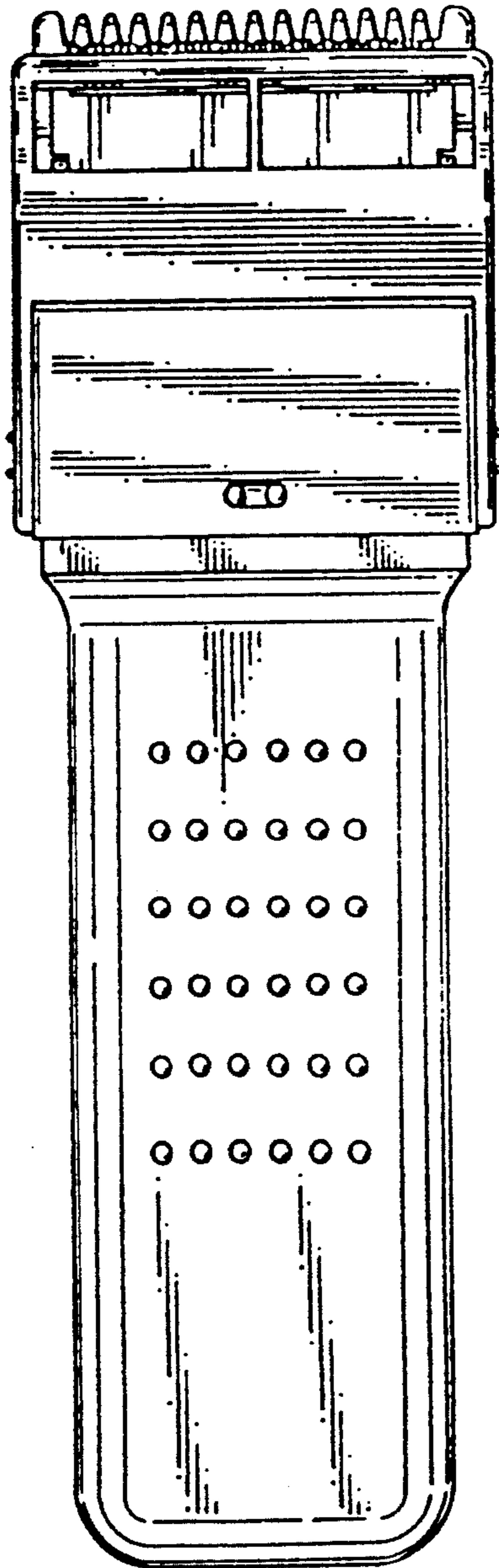

Fig. 2

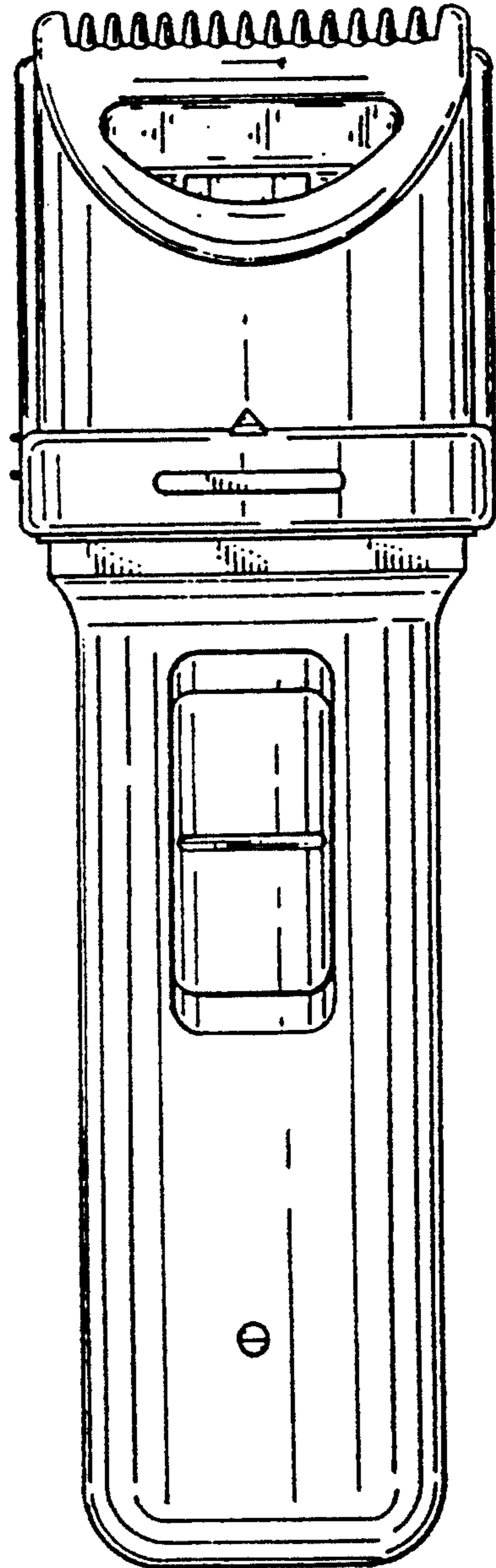

Fig. 3

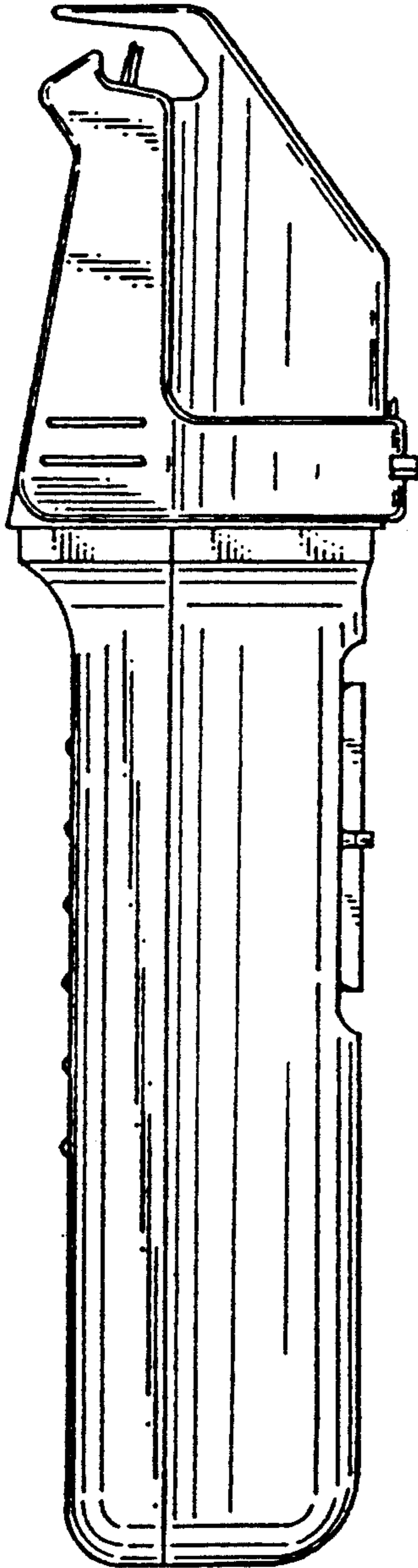

Fig. 4

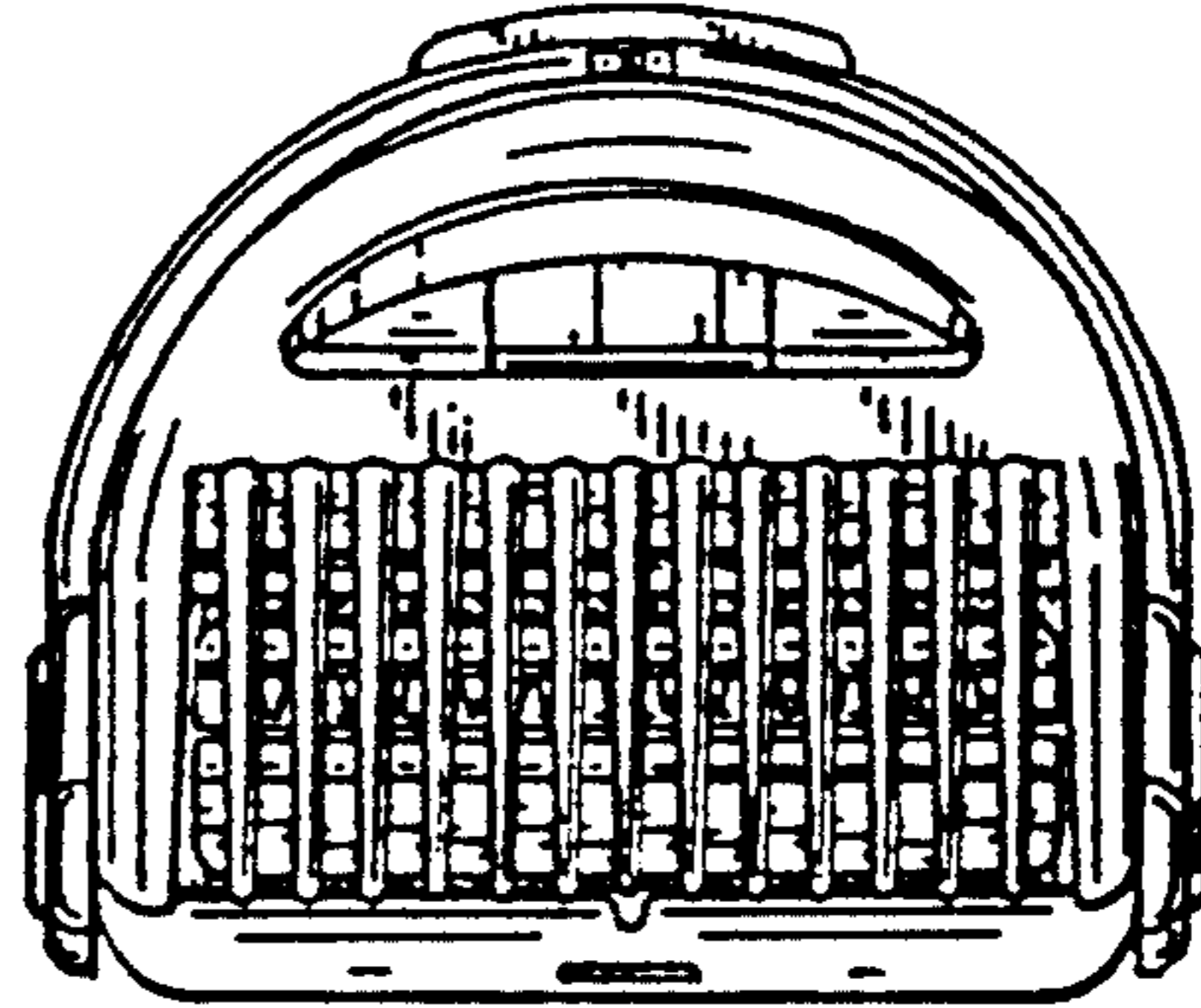
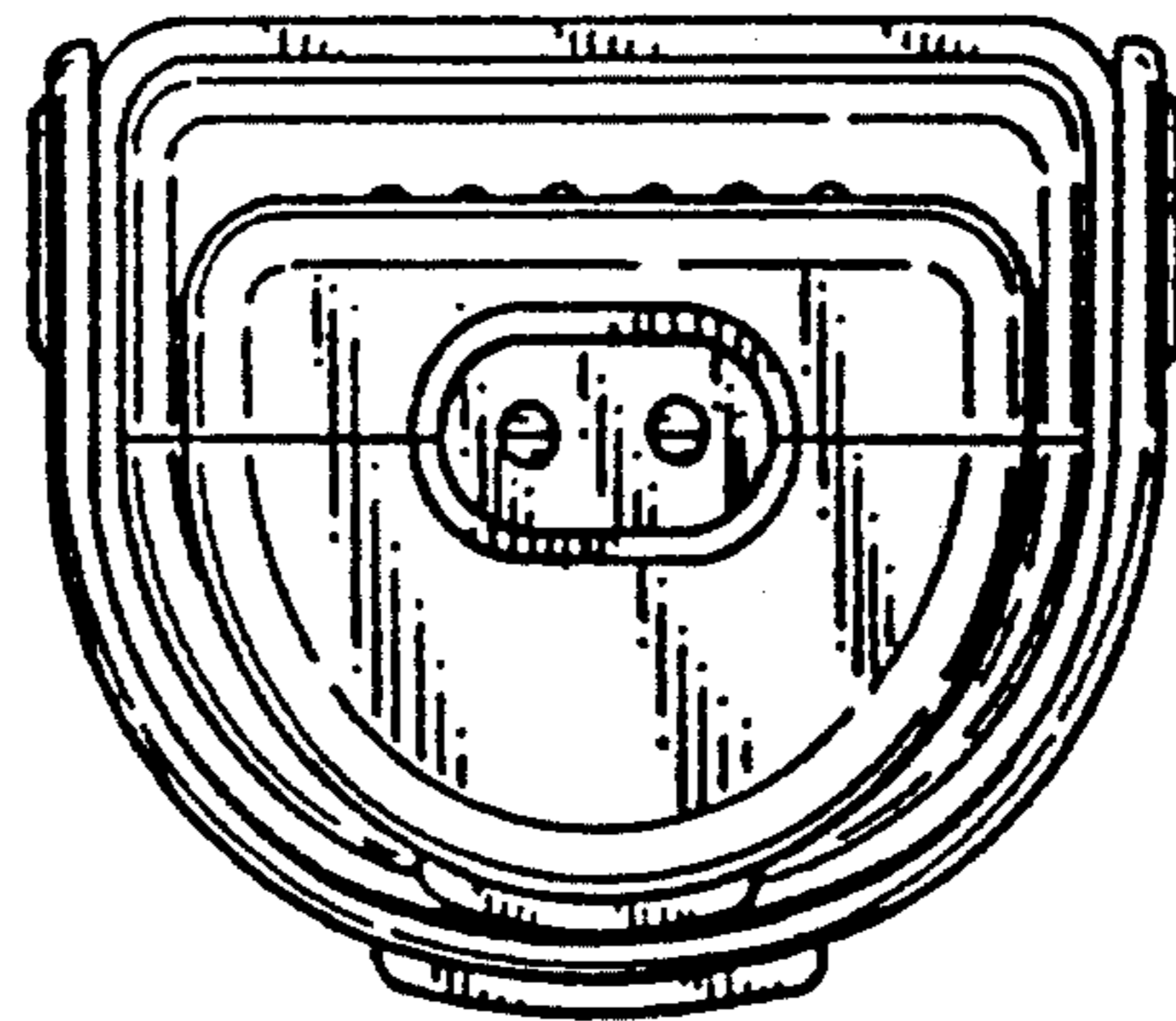

Fig. 5



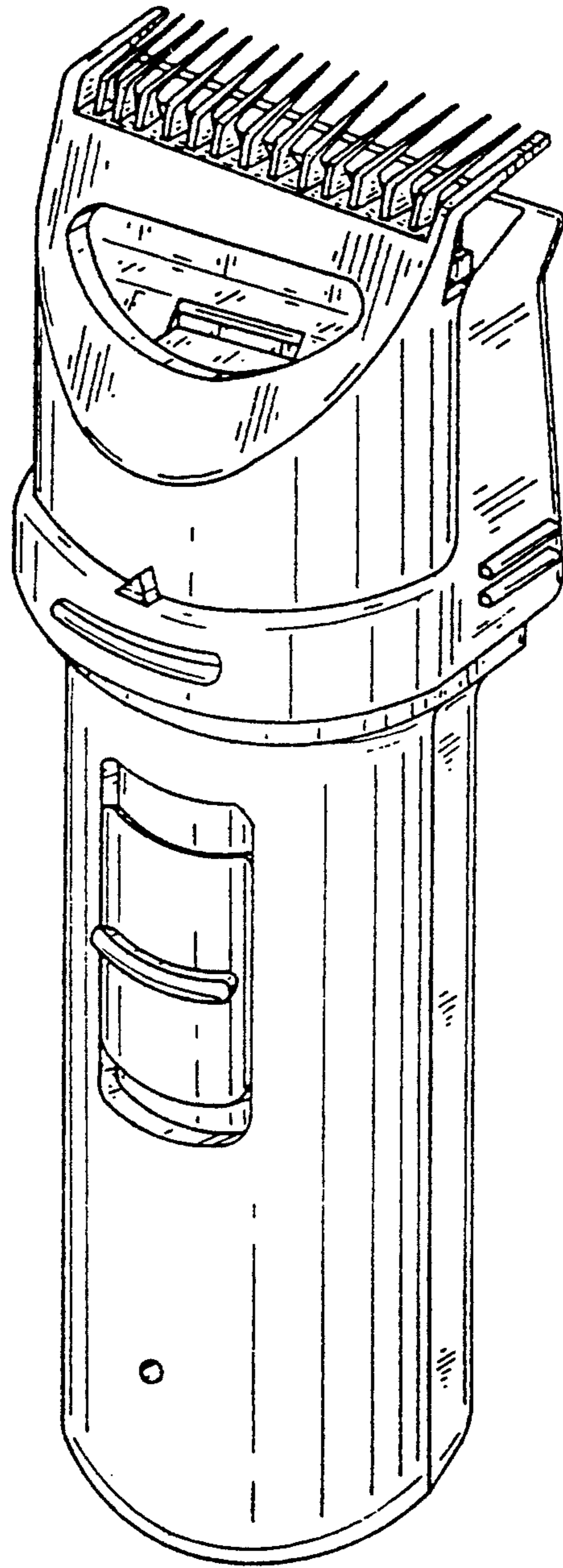

FIG. 6

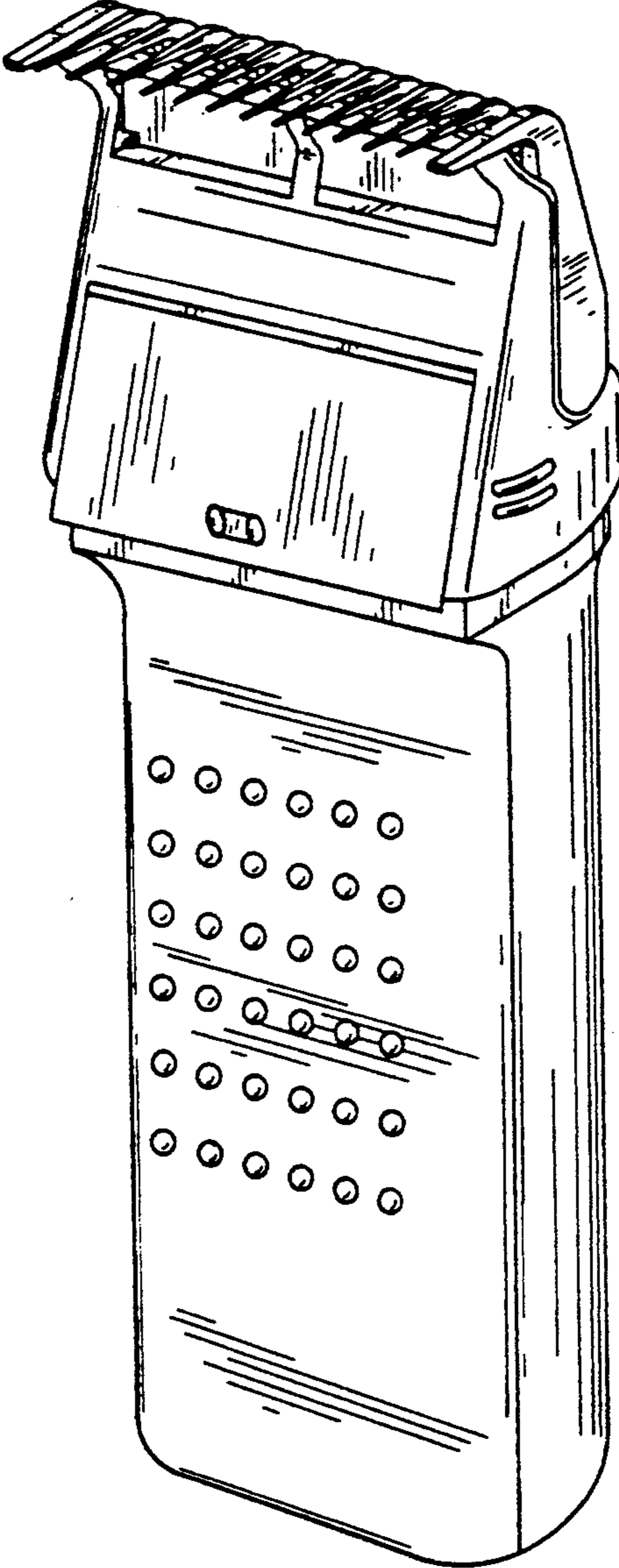

FIG. 7