



US00D346444S

United States Patent [19]

[11] Patent Number: **Des. 346,444**

Wade

[45] Date of Patent: **** Apr. 26, 1994**

[54] **COMBINED NEEDLE CAP REMOVER AND HOLDER**

[75] Inventor: **Steven E. Wade**, Winona, W. Va.

[73] Assignee: **Medical Safety Solutions, Inc.**, Warminster, Pa.

[**] Term: **14 Years**

[21] Appl. No.: **894,630**

[22] Filed: **Jun. 5, 1992**

[52] U.S. Cl. **D24/130**

[58] Field of Search **604/192, 263, 110; 248/231.3; 206/364, 365; D24/130**

4,915,698	4/1990	Levenson	604/192
4,921,199	5/1990	Villaveces	D24/130 X
4,938,514	7/1990	D'Addezio .	
4,979,945	12/1990	Wade et al.	D24/130 X
4,981,476	1/1991	Aichlmayr et al. .	
5,183,469	2/1993	Capaccio	206/365 X

Primary Examiner—A. Hugo Word
Assistant Examiner—I. Simmons
Attorney, Agent, or Firm—Kerkam, Stowell, Kondracki & Clarke

[57] CLAIM

The ornamental design for the combined needle cap remover and holder, as shown and described.

DESCRIPTION

FIG. 1 is a perspective view of a combined needle cap remover and holder, showing my new design; FIG. 2 is a side elevational view thereof; FIG. 3 is a front elevational view thereof; FIG. 4 is a rear elevational view thereof; FIG. 5 is a top view thereof taken in the direction of line 5—5 in FIG. 2; FIG. 6 is a top view thereof taken in the direction of line 6—6 in FIG. 2; and, FIG. 7 is a bottom plan view thereof.

[56] References Cited

U.S. PATENT DOCUMENTS

2,645,325	7/1953	Petit .	
2,709,563	5/1955	Starkey	D24/129 X
2,843,196	7/1958	Schauer .	
2,854,976	10/1958	Heydrich .	
3,021,942	2/1962	Hamilton .	
4,211,380	7/1980	Lillegard et al. .	
4,596,562	6/1986	Vernon	604/192
4,717,386	1/1988	Simmons .	
4,846,803	7/1989	Emerson .	

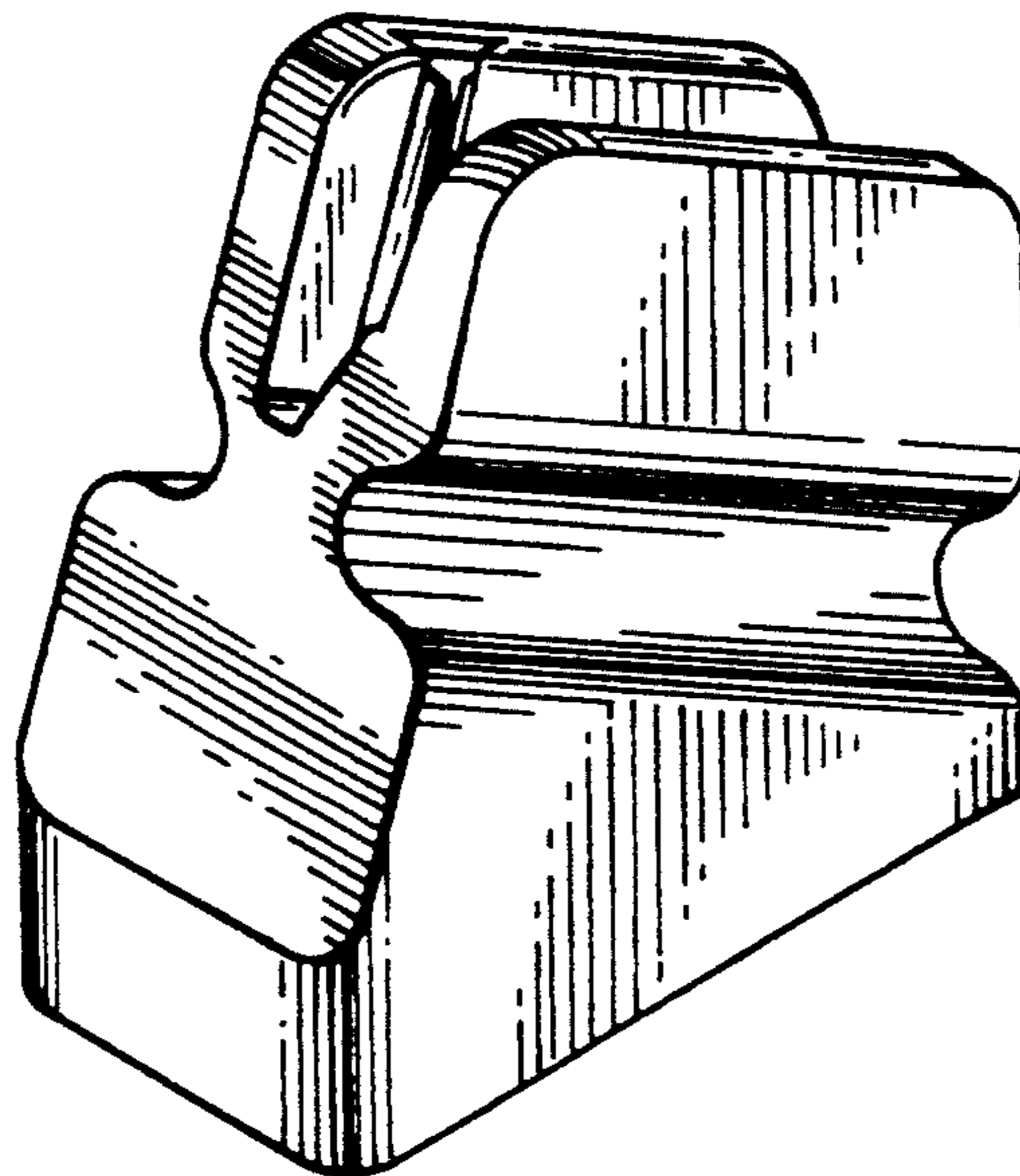

FIG. 1

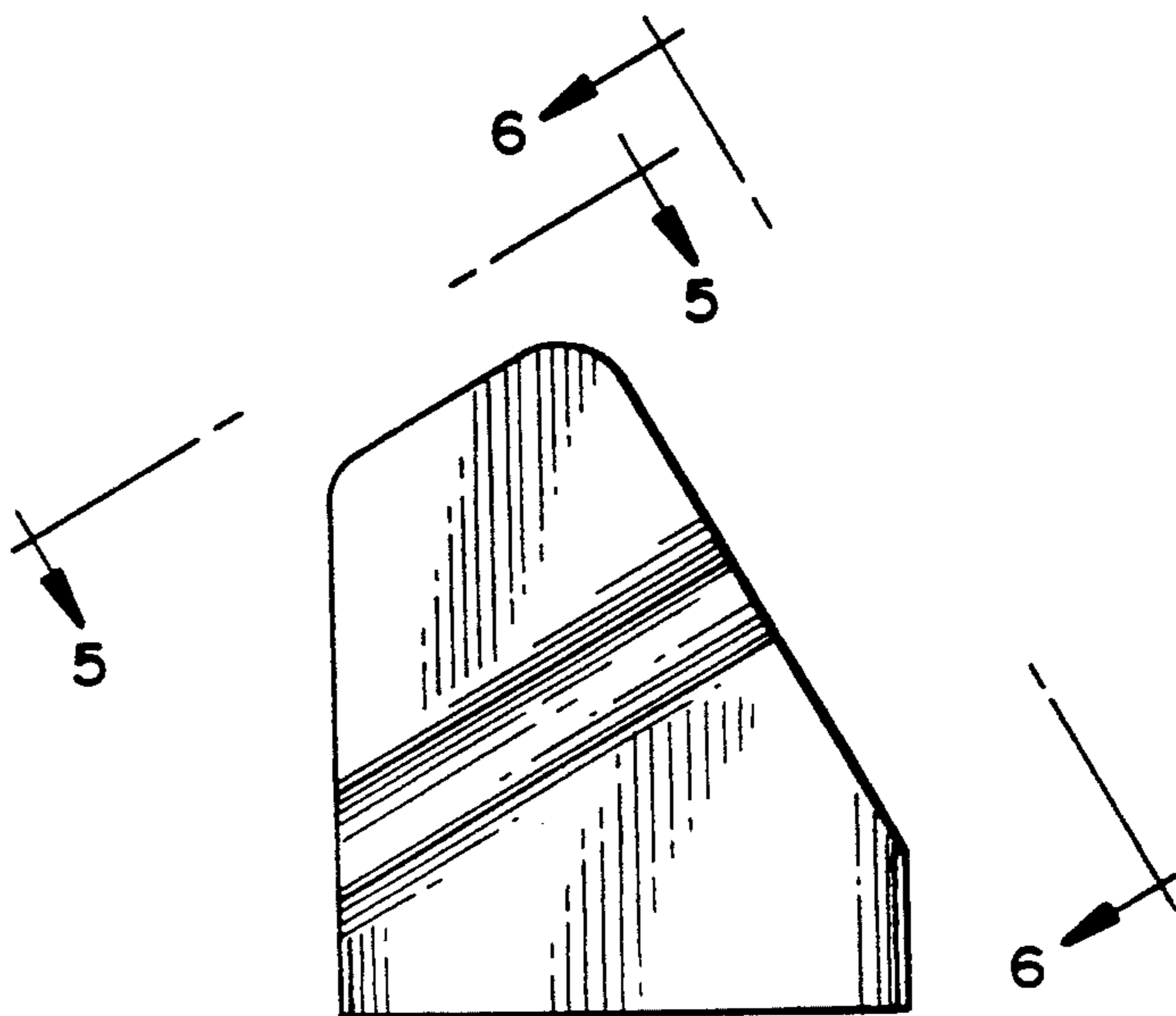
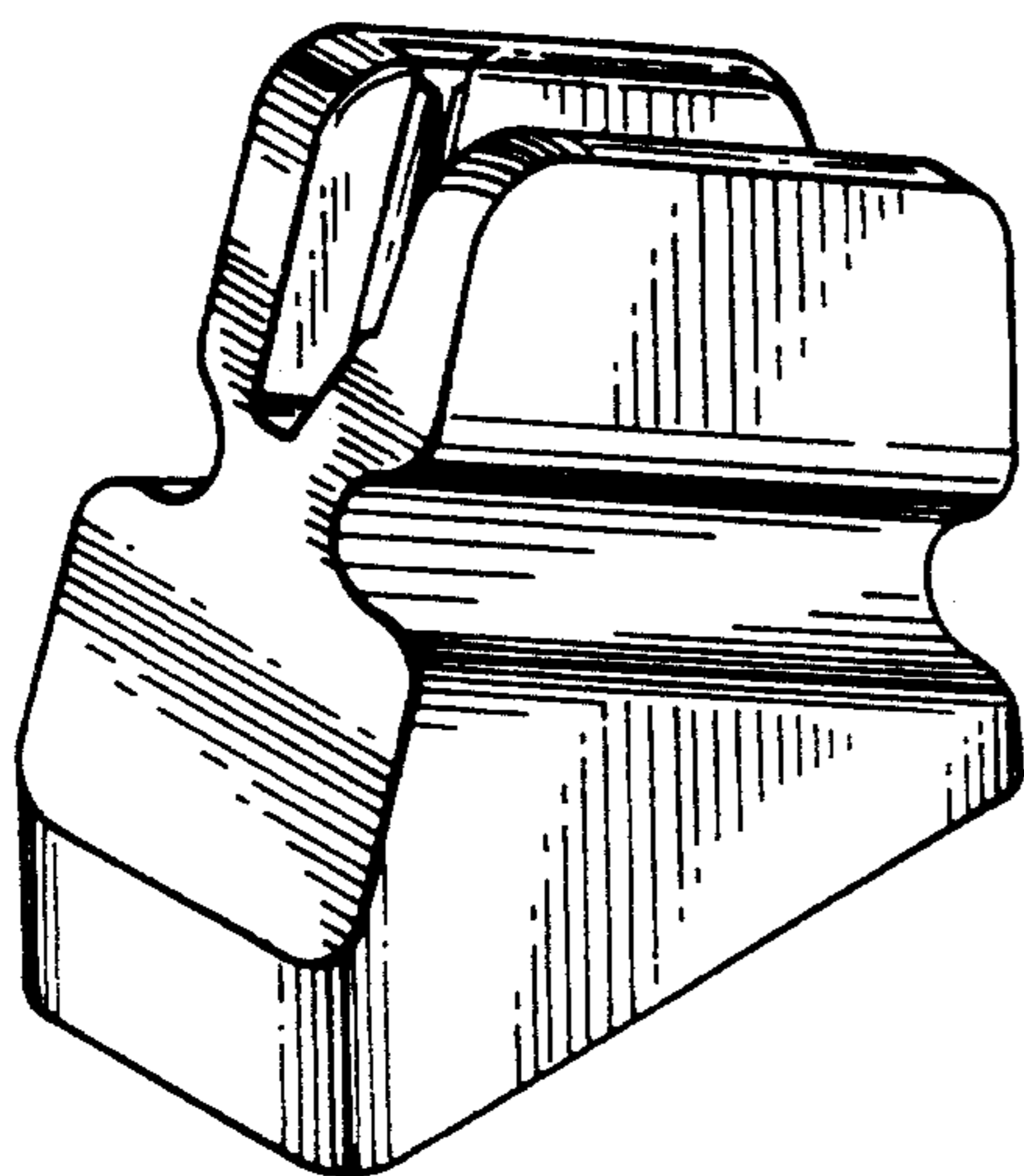

FIG. 2



FIG. 3

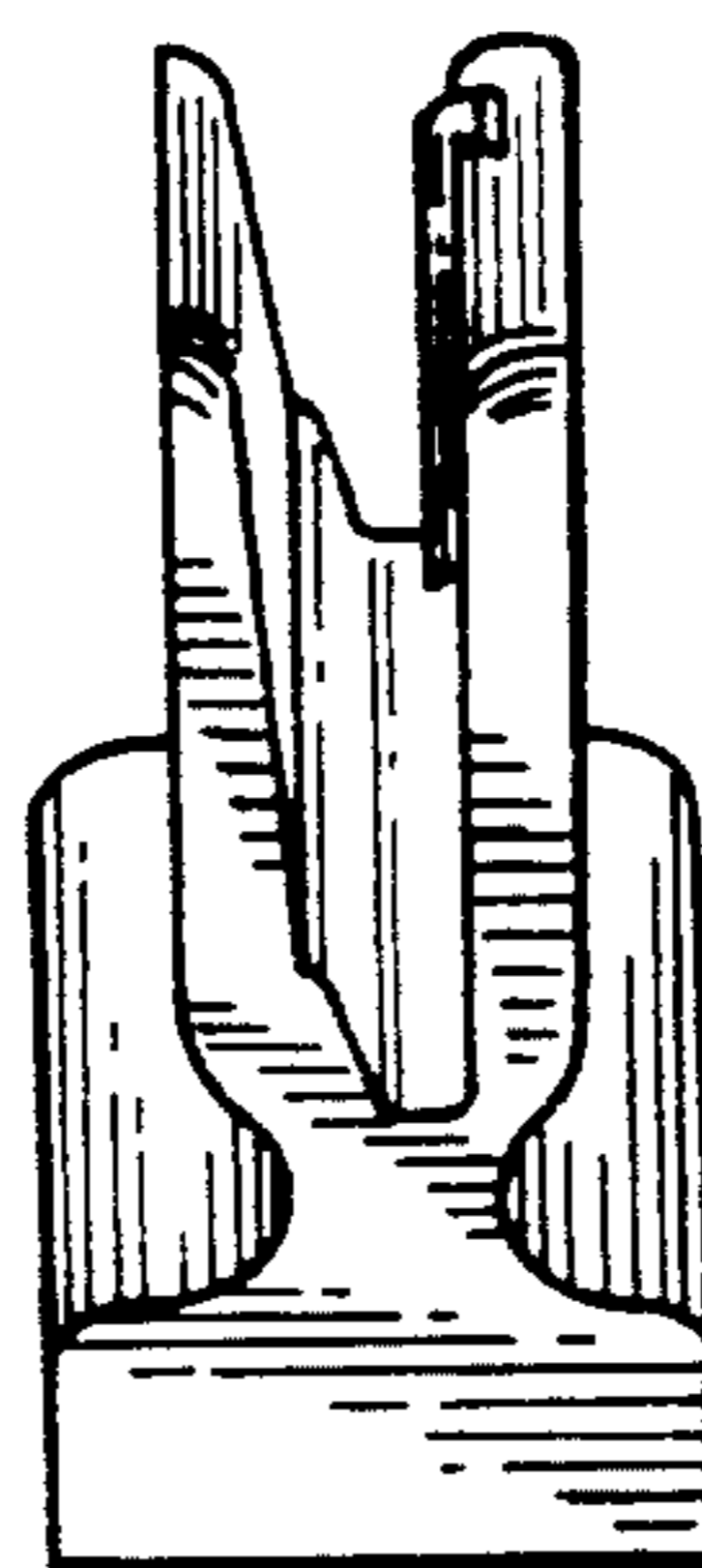

FIG. 4



FIG. 5

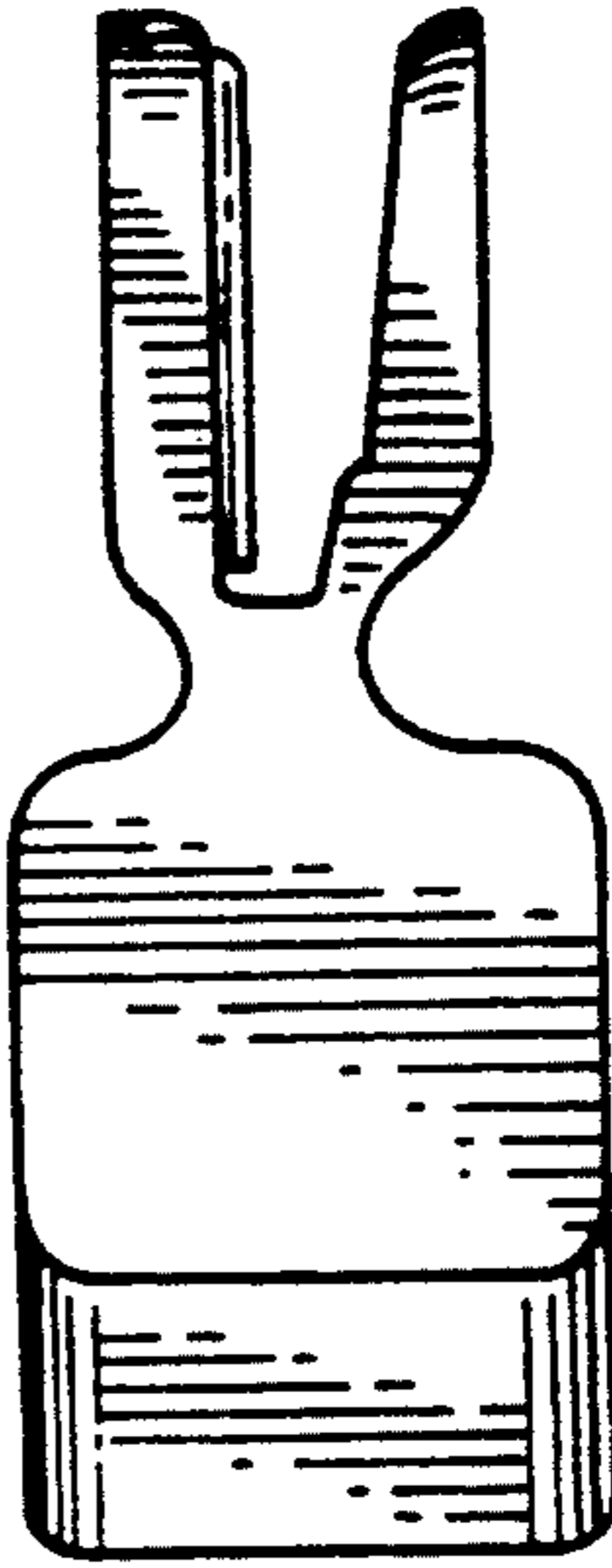

FIG. 6

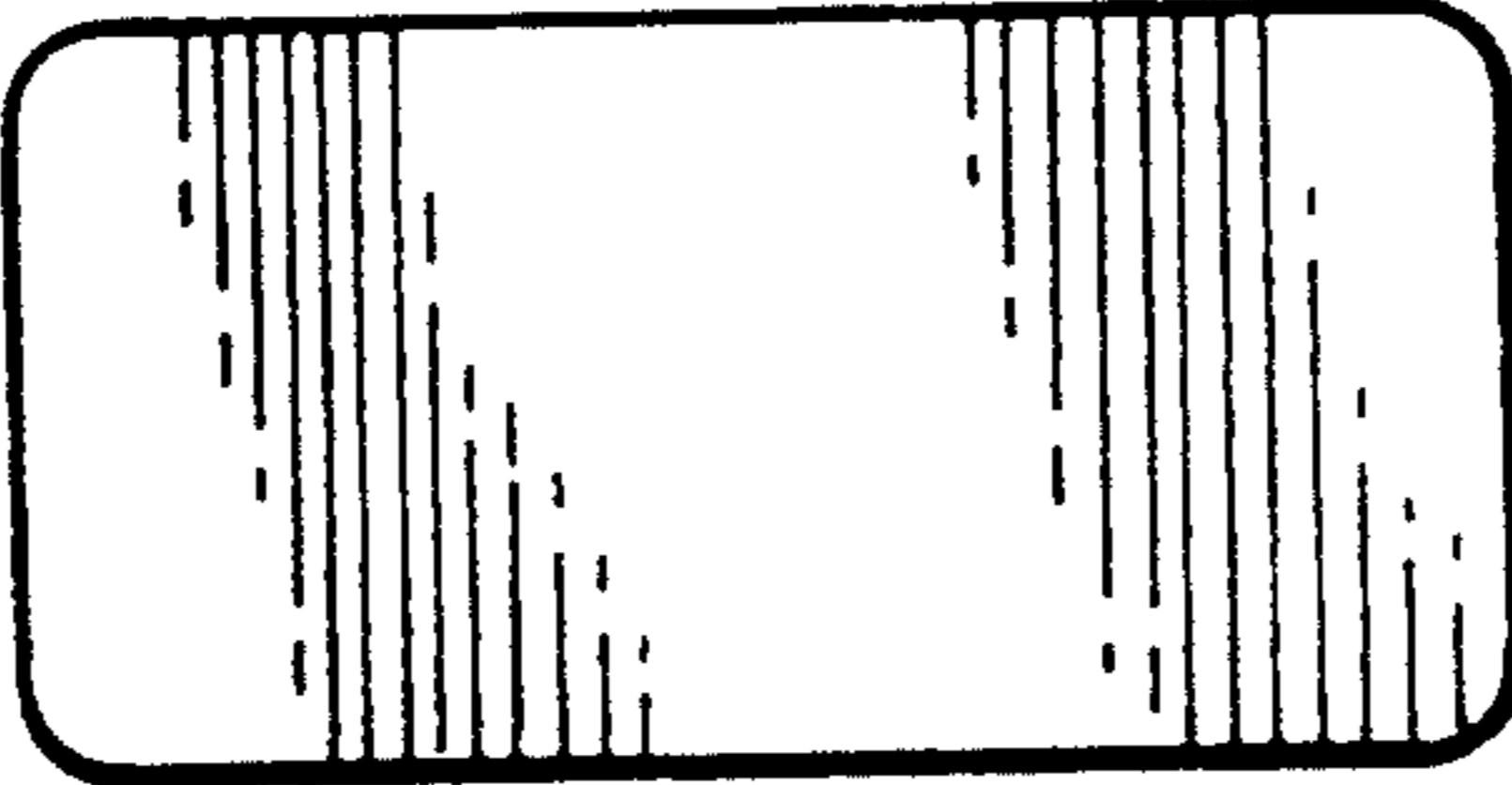

FIG. 7