



US00D346414S

# United States Patent [19]

[11] Patent Number: **Des. 346,414**

Wong

[45] Date of Patent: **\*\* Apr. 26, 1994**

[54] **TOY MOTORCYCLE WITH RIDER**  
 [75] Inventor: **Chi P. Wong, Chai Wan, Hong Kong**  
 [73] Assignee: **Lun Cheung Enterprises Limited, Chia Wan, Hong Kong**  
 [\*\*] Term: **14 Years**  
 [21] Appl. No.: **22**  
 [22] Filed: **Oct. 5, 1992**

D. 275,505 9/1984 Takasaka ..... D21/134  
 D. 321,849 11/1991 Abe ..... D12/110  
 4,181,190 1/1980 Yang ..... 280/293  
 4,685,530 8/1987 Hara ..... 180/219

### FOREIGN PATENT DOCUMENTS

2227679 8/1990 United Kingdom ..... 446/440

*Primary Examiner*—Bernard Ansher  
*Assistant Examiner*—R. Barkai  
*Attorney, Agent, or Firm*—Oliff & Berridge

[30] **Foreign Application Priority Data**  
 Apr. 29, 1992 [GB] United Kingdom ..... 2022610  
 [52] **U.S. Cl.** ..... **D21/134**  
 [58] **Field of Search** ..... 446/451, 440;  
 280/87.01, 87.041, 87.021, 87.043, 827, 282, 62,  
 270, 293, 274, 281.1, 288.2, 288.3, 263; 180/219;  
 D21/71, 74, 76, 78, 80-81, 134, 157; D12/87,  
 110

### [57] CLAIM

The ornamental design for toy motorcycle with rider, as shown.

### DESCRIPTION

FIG. 1 is a top plan view of a toy motorcycle with rider showing my new design;  
 FIG. 2 is a bottom perspective view thereof;  
 FIG. 3 is a front elevational view thereof;  
 FIG. 4 is a rear elevational view thereof;  
 FIG. 5 is a right side elevational view thereof;  
 FIG. 6 is a left side elevational view thereof; and,  
 FIG. 7 is a front, right side perspective view thereof.

[56] **References Cited**  
**U.S. PATENT DOCUMENTS**  
 D. 208,484 9/1967 Wetherell ..... D21/134  
 D. 269,099 5/1983 Goldfarb ..... D21/134

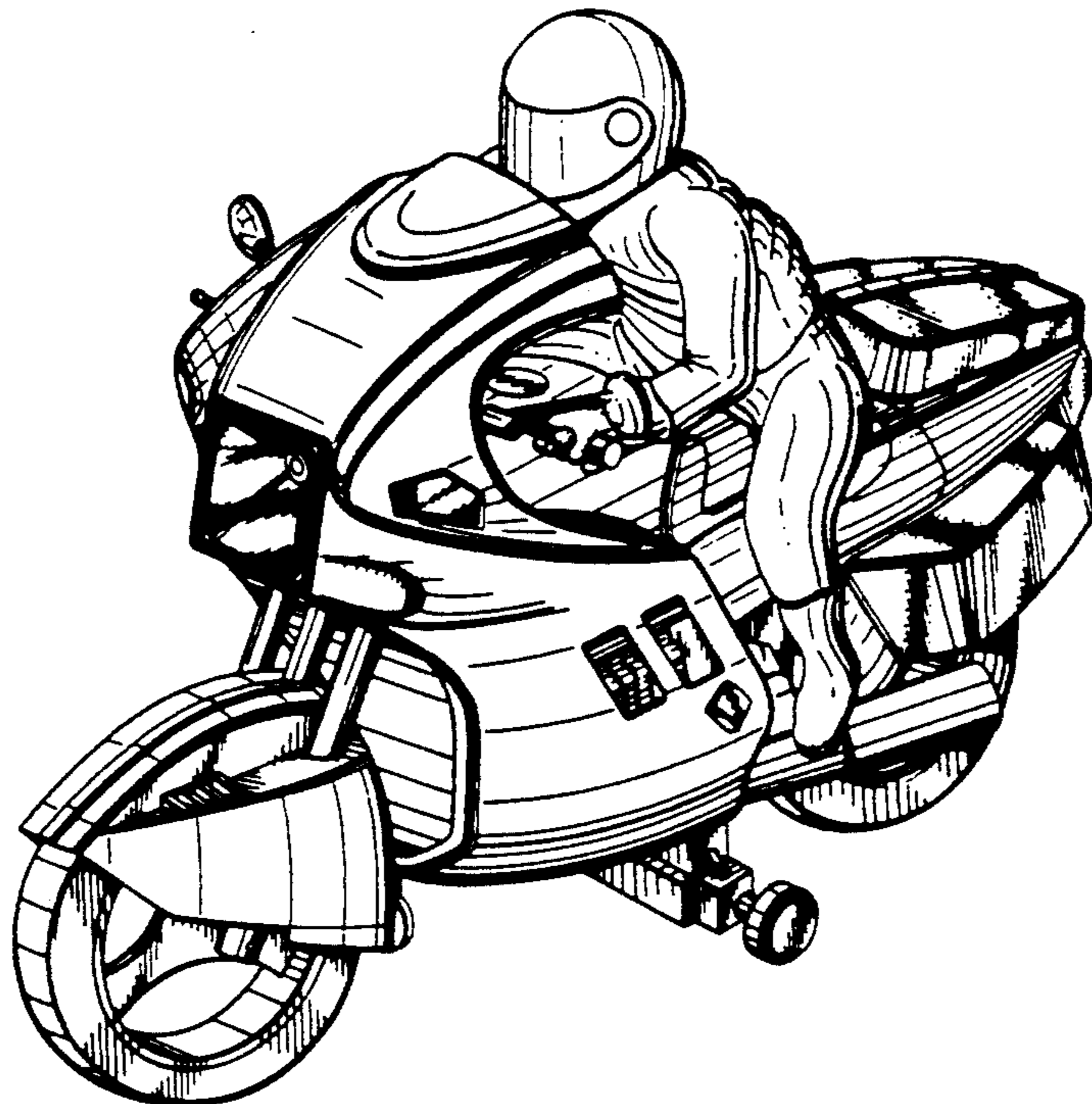

FIG. 1

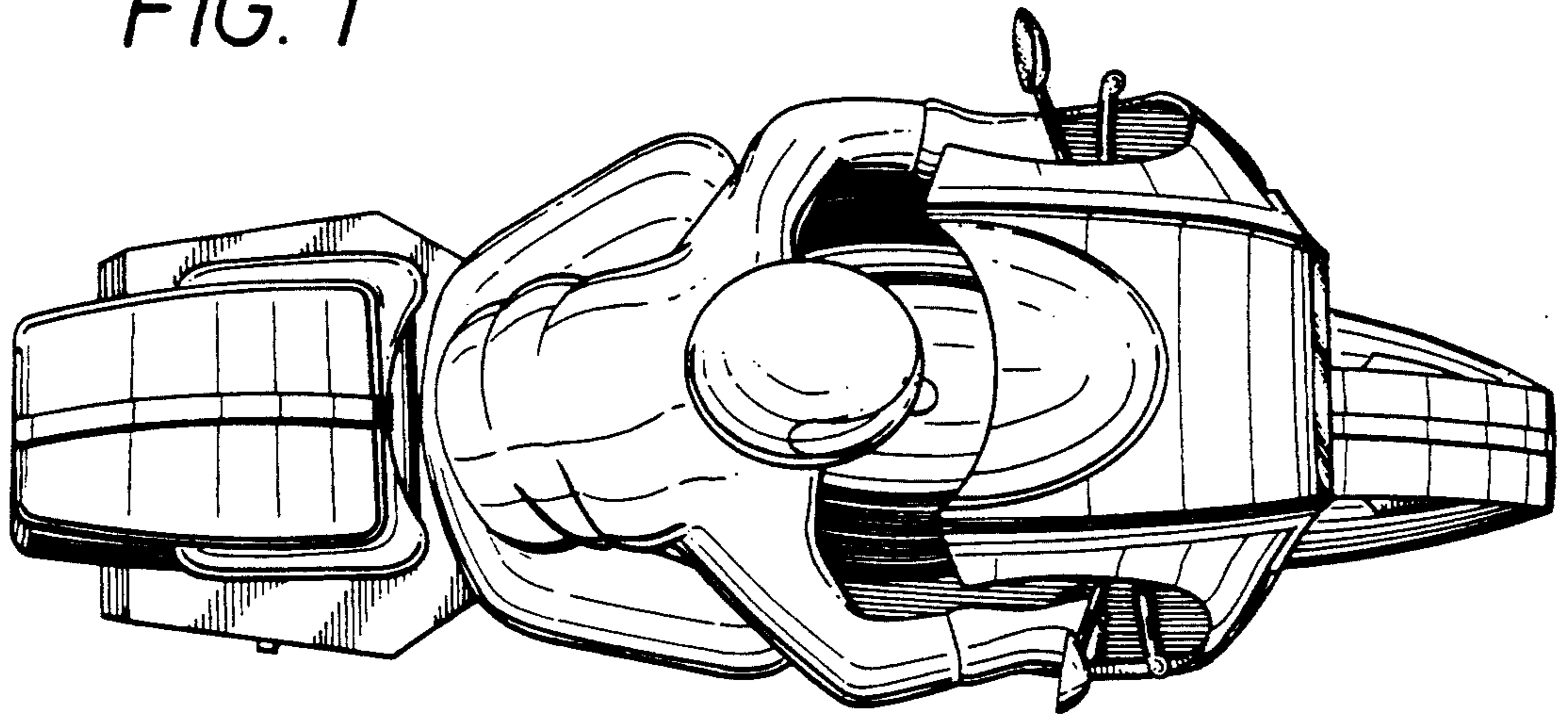

FIG. 2

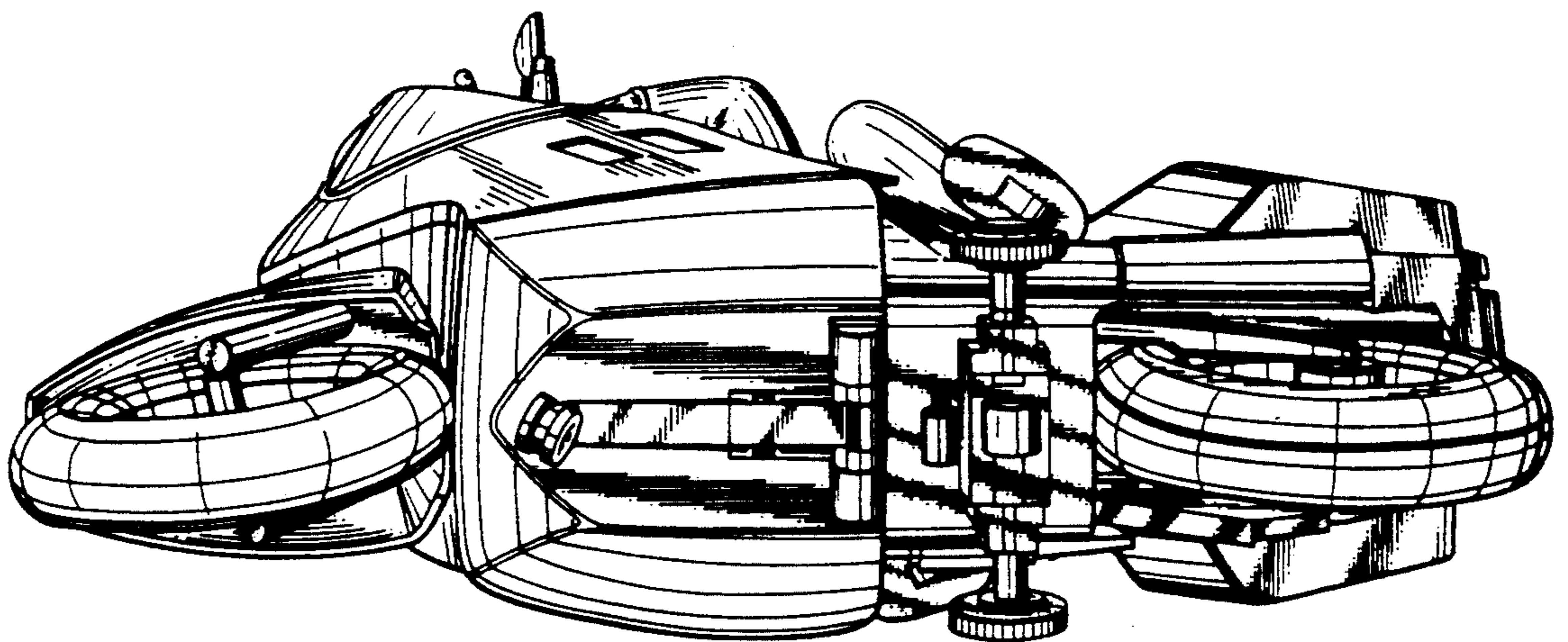

FIG. 3

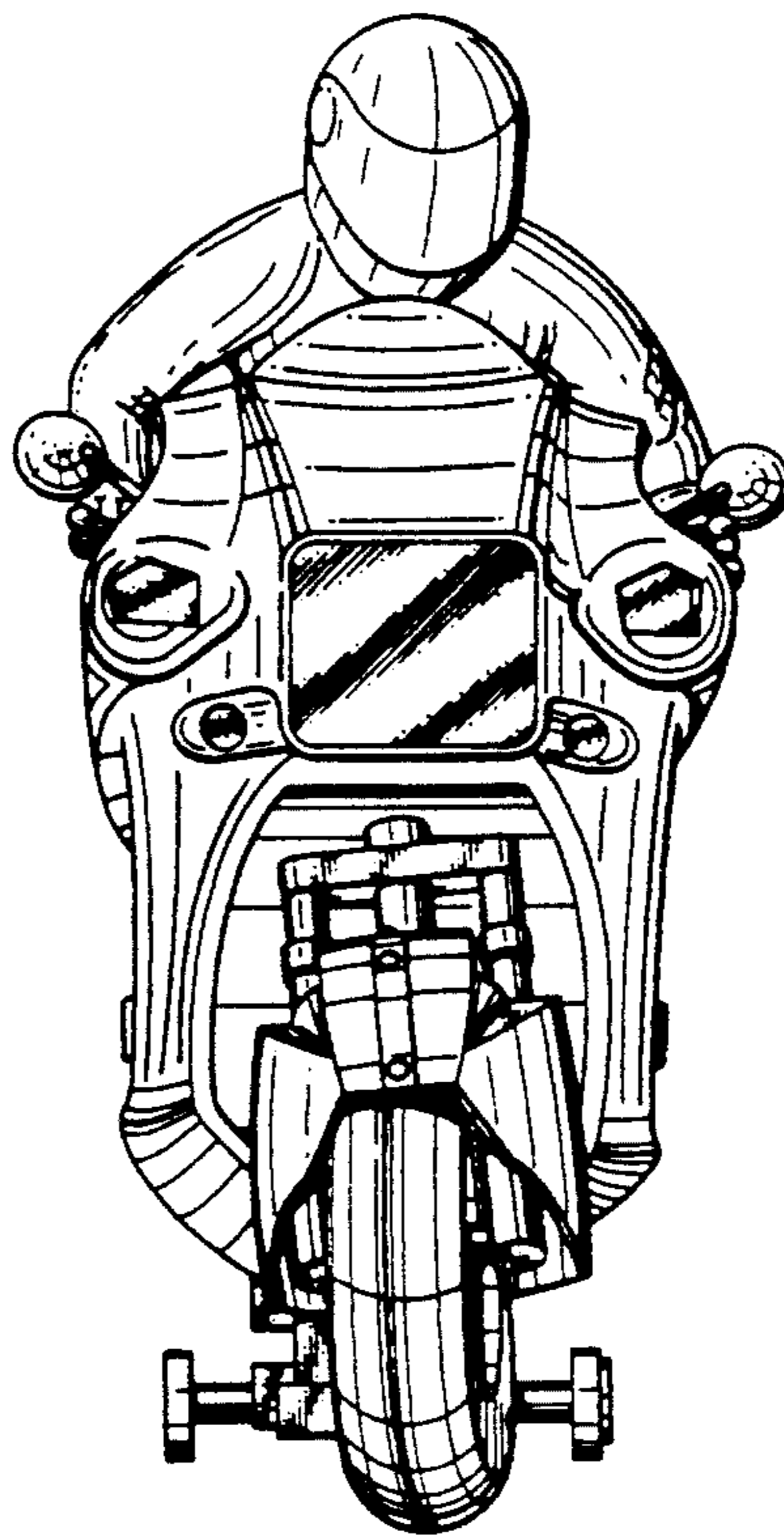

FIG. 4

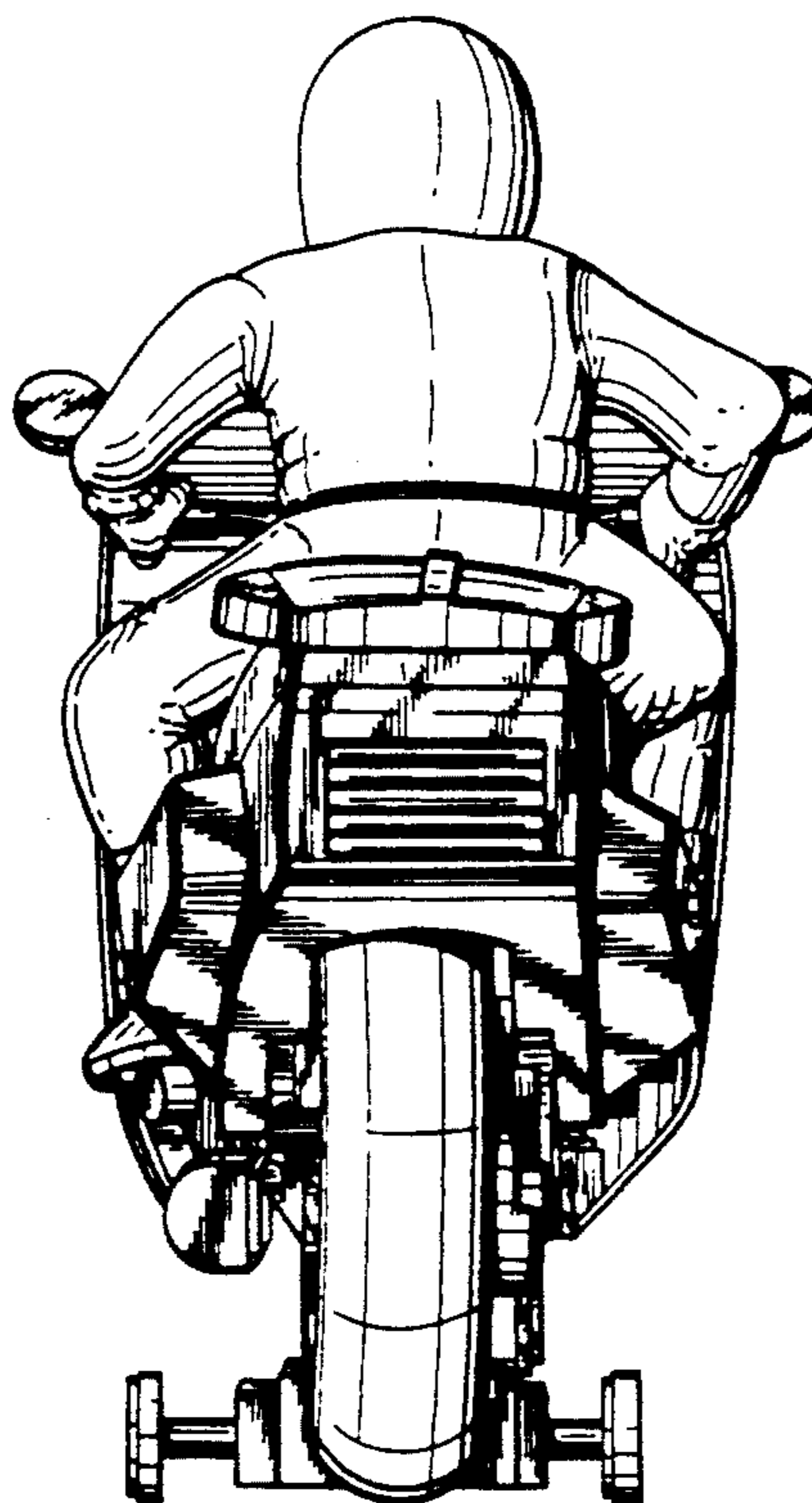

FIG. 5

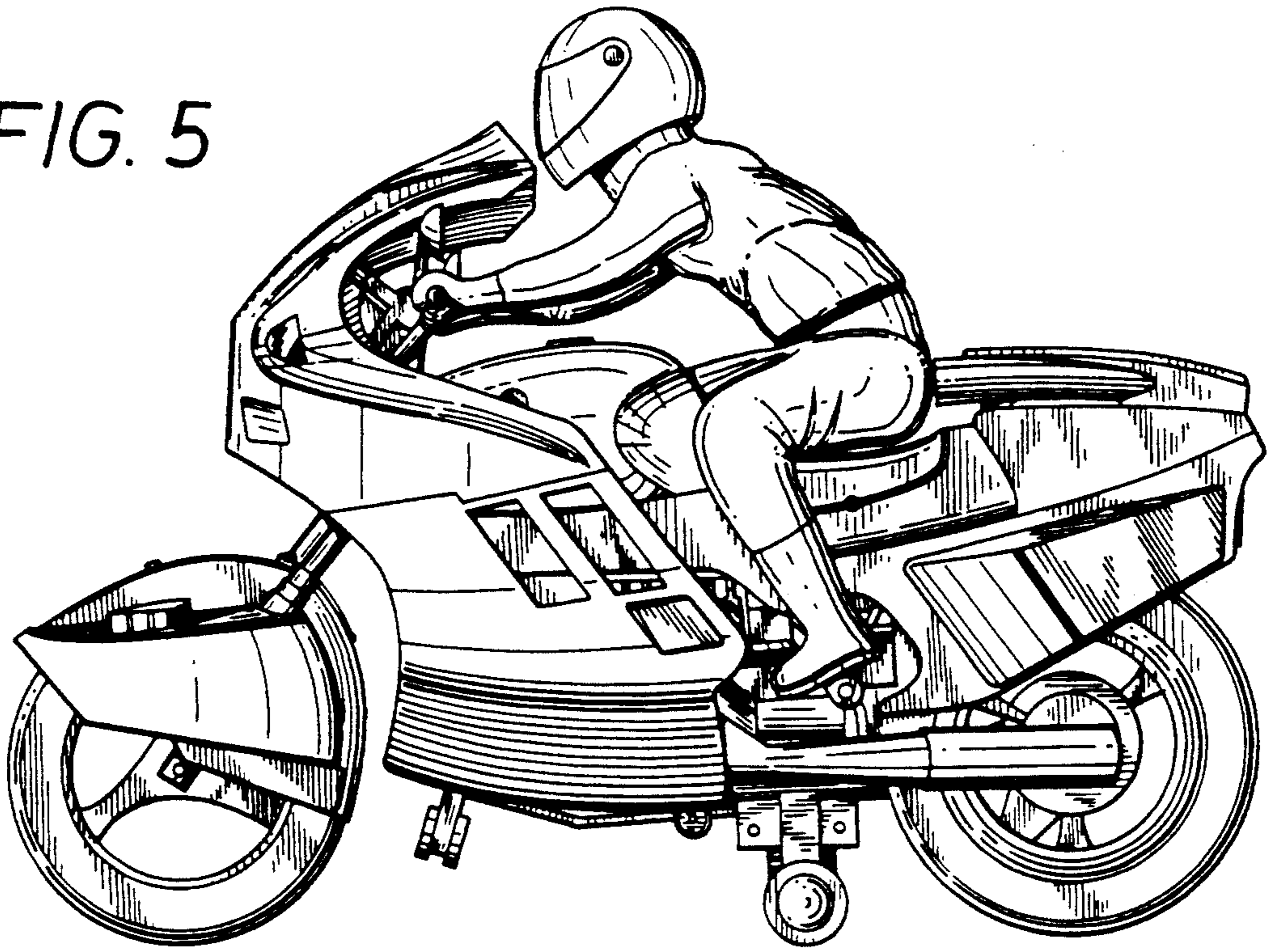

FIG. 6

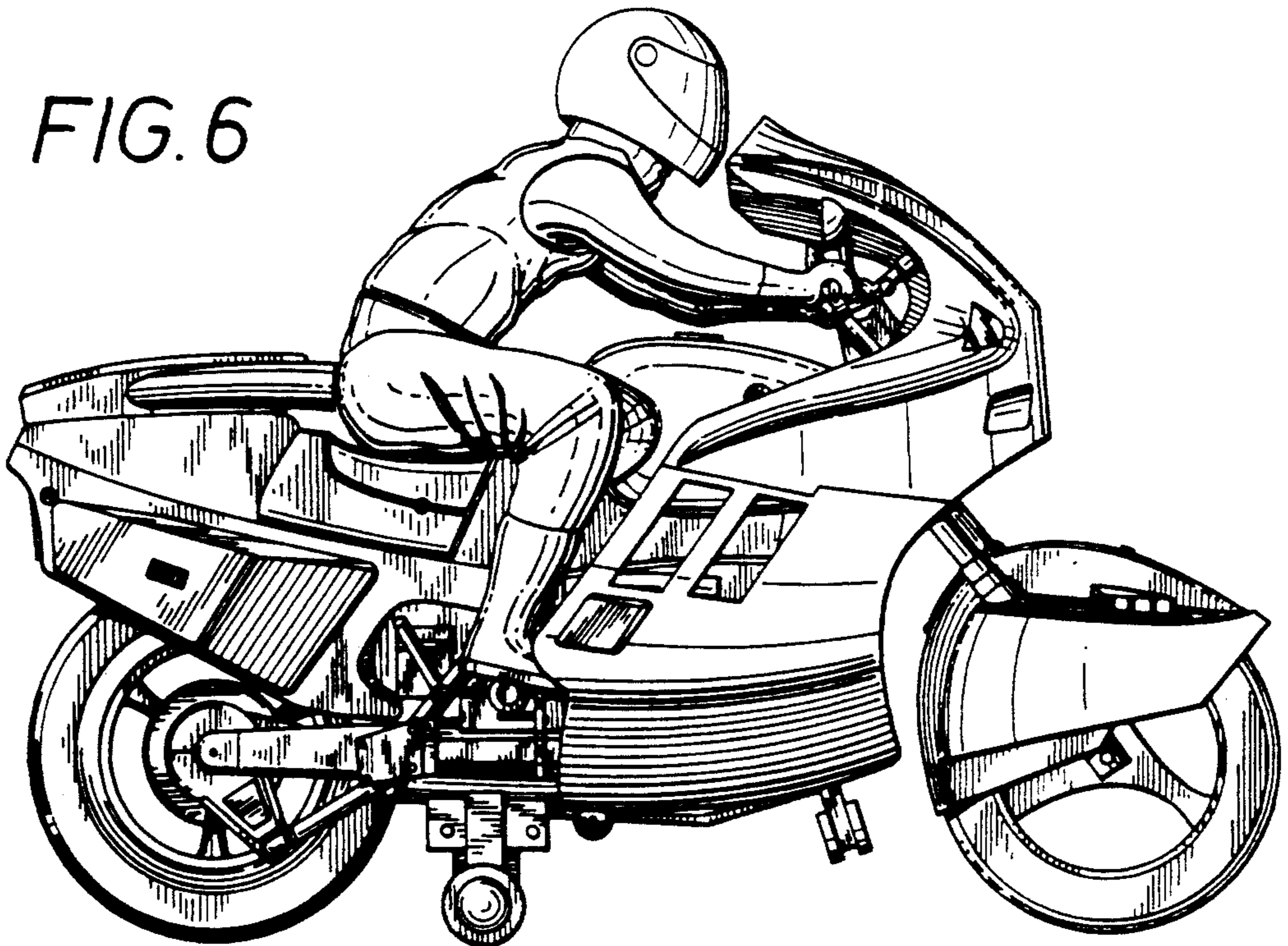
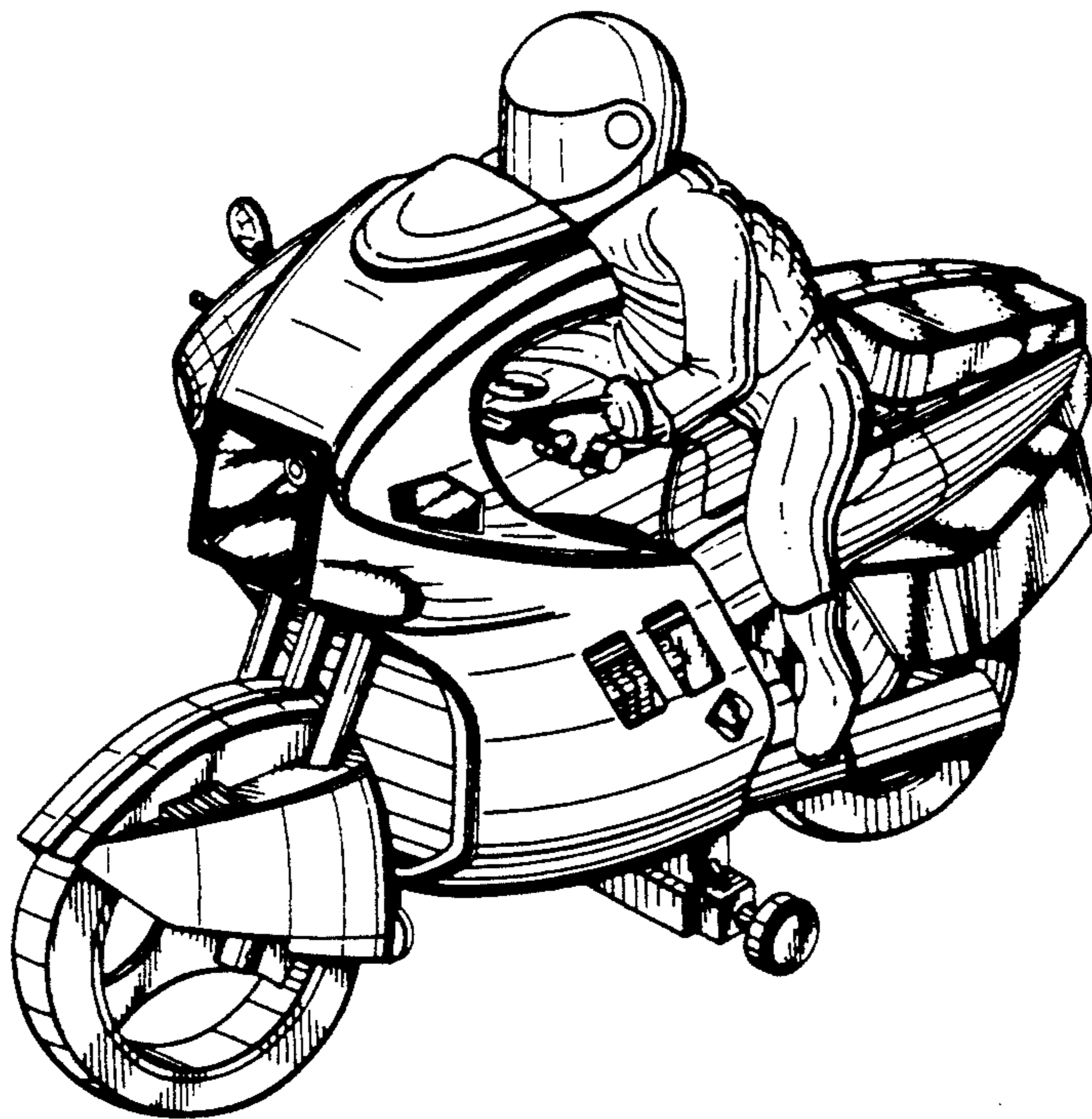

FIG. 7



UNITED STATES PATENT AND TRADEMARK OFFICE  
**CERTIFICATE OF CORRECTION**

PATENT NO. : Des. 346,414  
DATED : April 26, 1994  
INVENTOR(S) : Chi P. Wong

It is certified that error appears in the above-identified patent and that said Letters Patent is hereby corrected as shown below:

**ON THE COVER PAGE:**

item [21] Appl. No.: change "22" to --29/000,022--.

Signed and Sealed this  
Ninth Day of August, 1994



BRUCE LEHMAN

Attest:

Attesting Officer

Commissioner of Patents and Trademarks