



US00D346389S

United States Patent [19]

[11] Patent Number: **Des. 346,389**

Lindholm

[45] Date of Patent: **** Apr. 26, 1994**

[54] **ICE-CREAM MAKER**

[75] Inventor: **Jon W. Lindholm**, Groningen, Netherlands

[73] Assignee: **U.S. Philips Corporation**, New York, N.Y.

[**] Term: **14 Years**

[21] Appl. No.: **824,783**

[22] Filed: **Jan. 23, 1992**

[30] **Foreign Application Priority Data**

Sep. 6, 1991 [WO] World Int. Prop. O. ... DM/020.607

[52] U.S. Cl. **D15/82**

[58] Field of Search D7/376, 380; 62/76, 62/305, 309, 342, 374, 376; D15/79, 80, 82

[56] **References Cited**

U.S. PATENT DOCUMENTS

- D. 251,432 3/1979 Sawada et al. D15/82
- D. 276,404 11/1984 Doyel D7/380

- D. 293,448 12/1987 Uesaka D15/82
- D. 294,328 2/1988 Uesaka D7/376
- D. 321,697 11/1991 Blaustein et al. D15/82
- D. 323,513 1/1992 van Asten D15/82
- 5,022,315 6/1991 Bertram et al. 62/342

Primary Examiner—B. J. Bullock
Assistant Examiner—Sandra Morris
Attorney, Agent, or Firm—Jack E. Haken

[57] **CLAIM**

The ornamental design for an ice-cream maker, as shown.

DESCRIPTION

FIG. 1 is a top, right side perspective view showing our new design;
FIG. 2 is a left side elevational view thereof;
FIG. 3 is a right side elevational view thereof;
FIG. 4 is a front elevational view thereof;
FIG. 5 is a rear elevational view thereof;
FIG. 6 is a top plan view thereof; and,
FIG. 7 is a bottom plan view thereof.

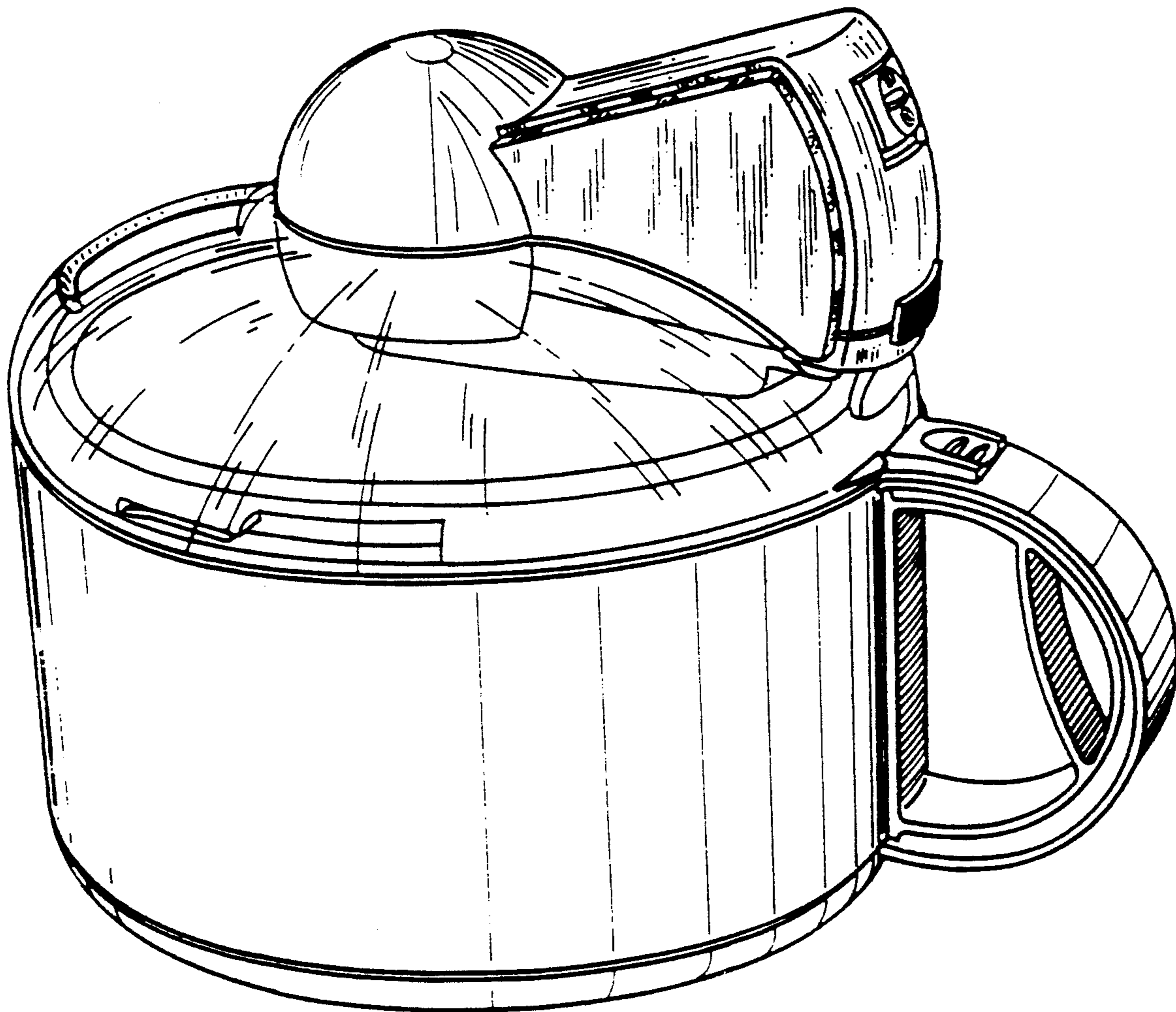

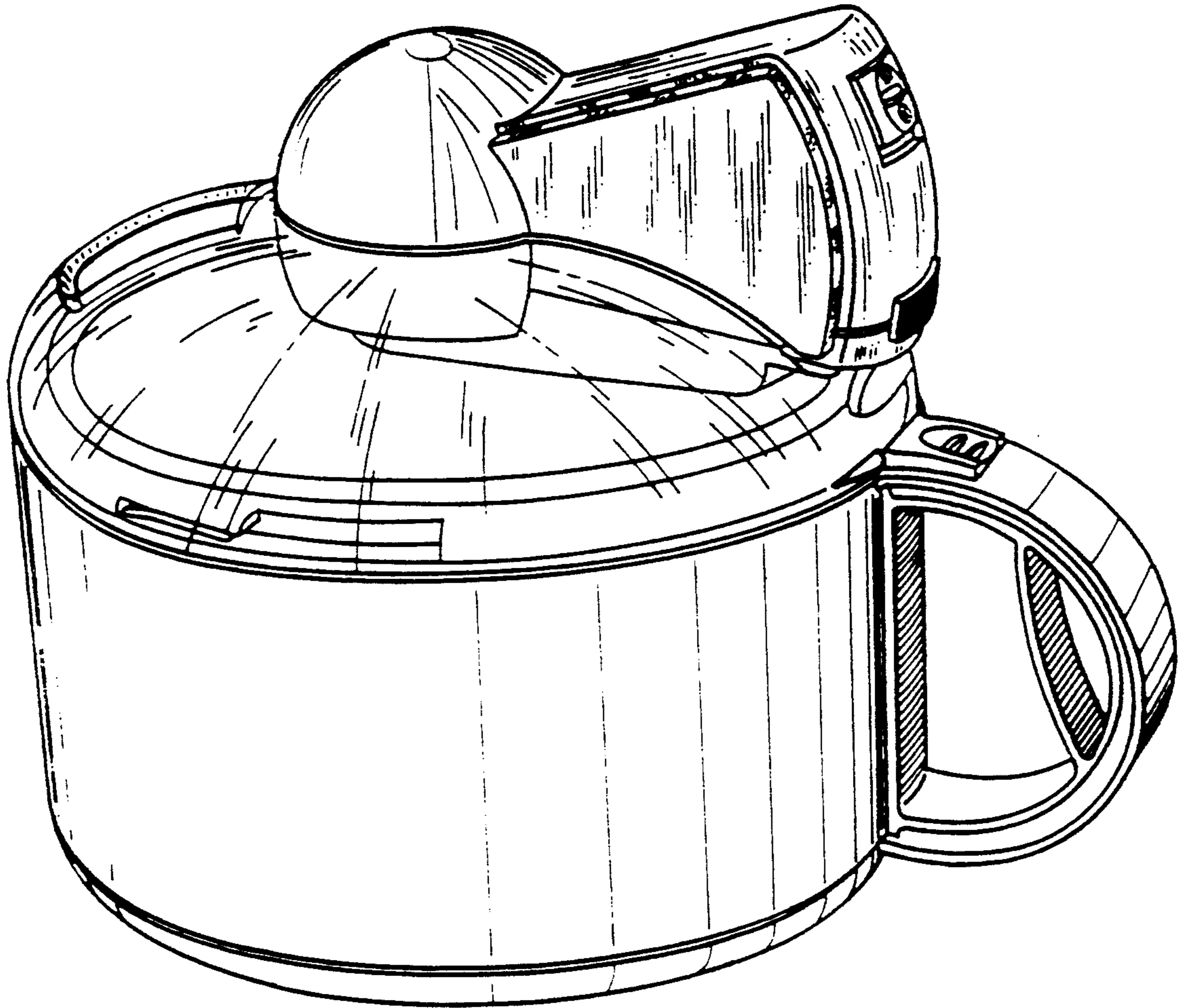

FIG. 1

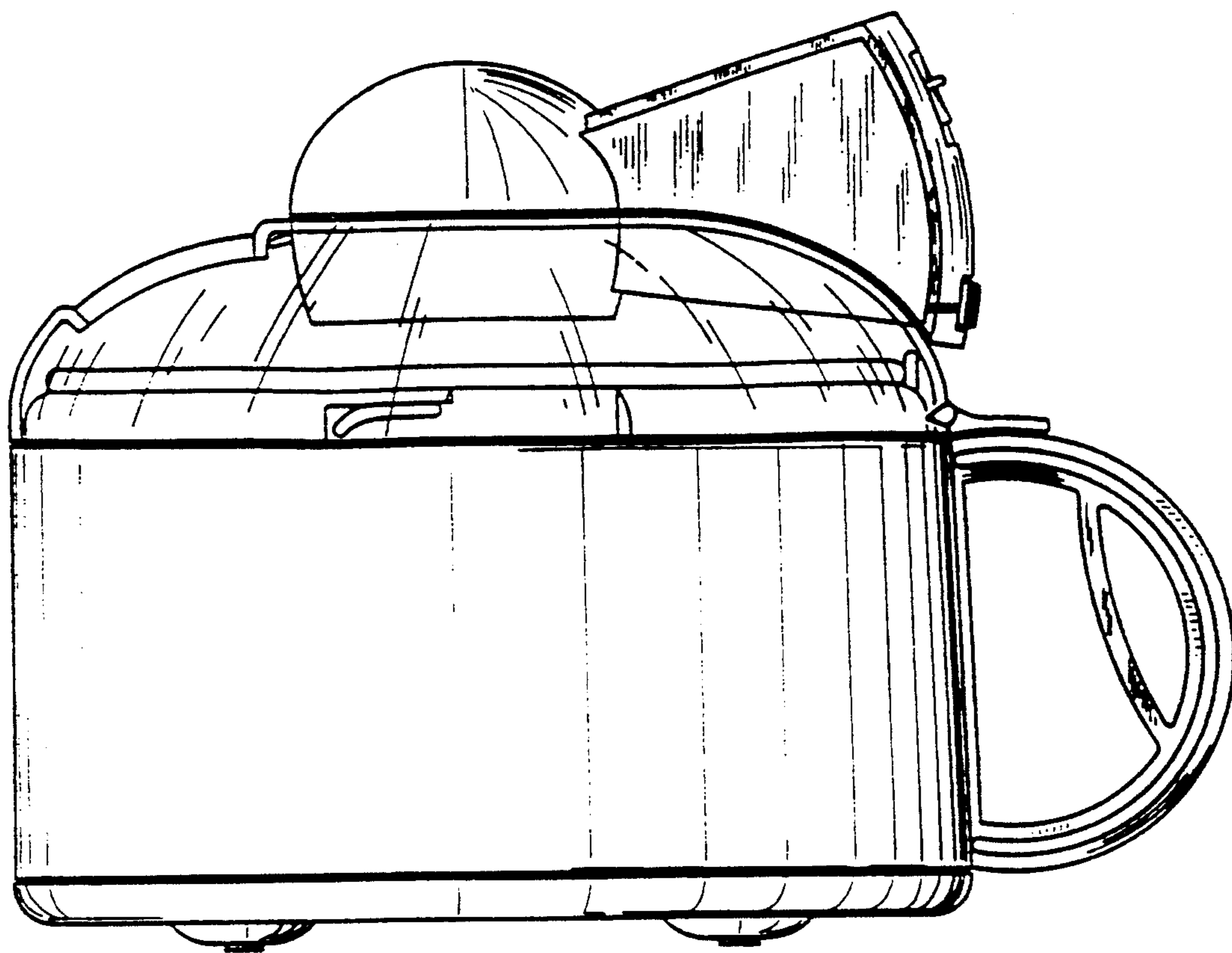

FIG. 2

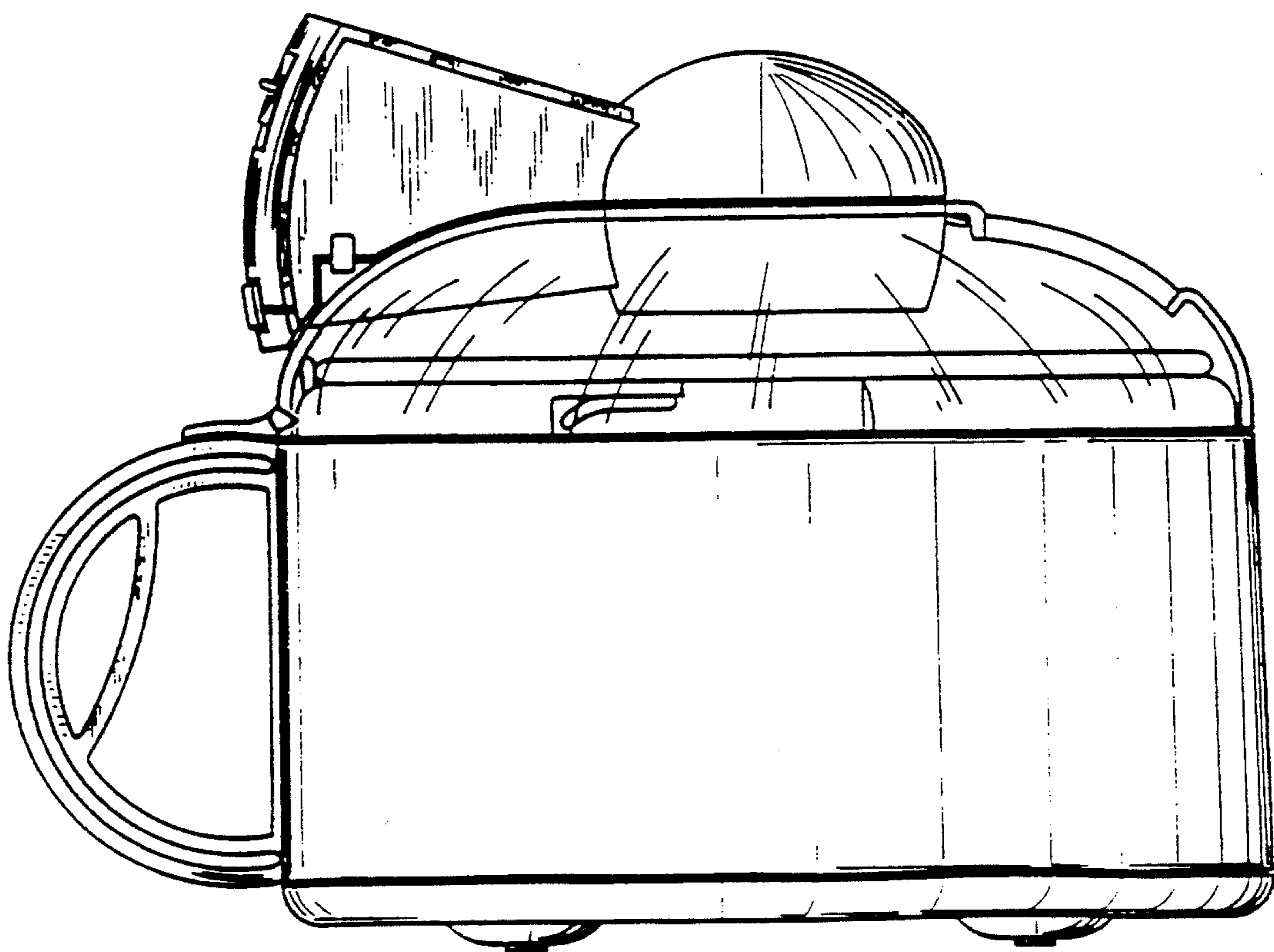

FIG. 3

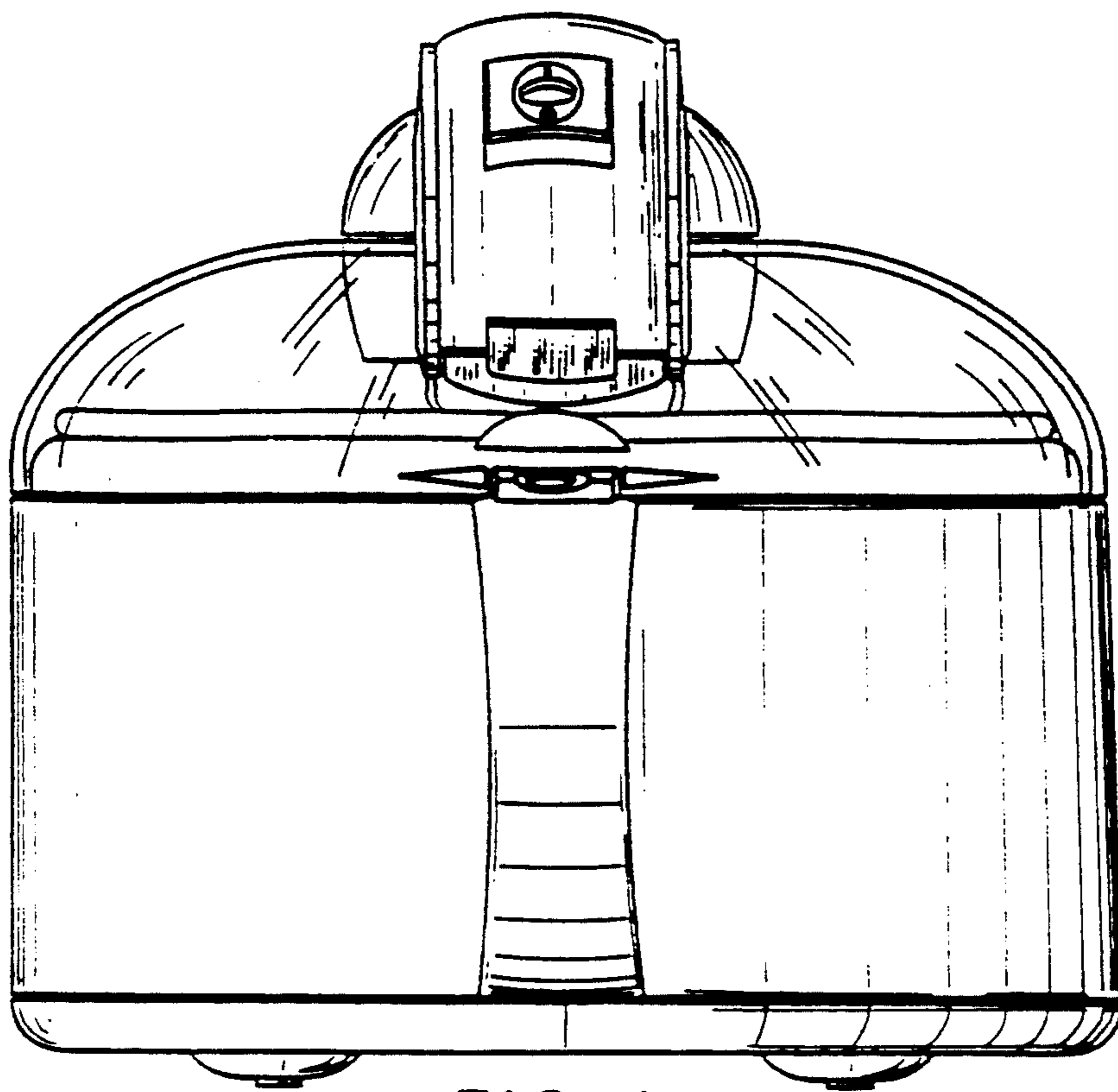

FIG. 4

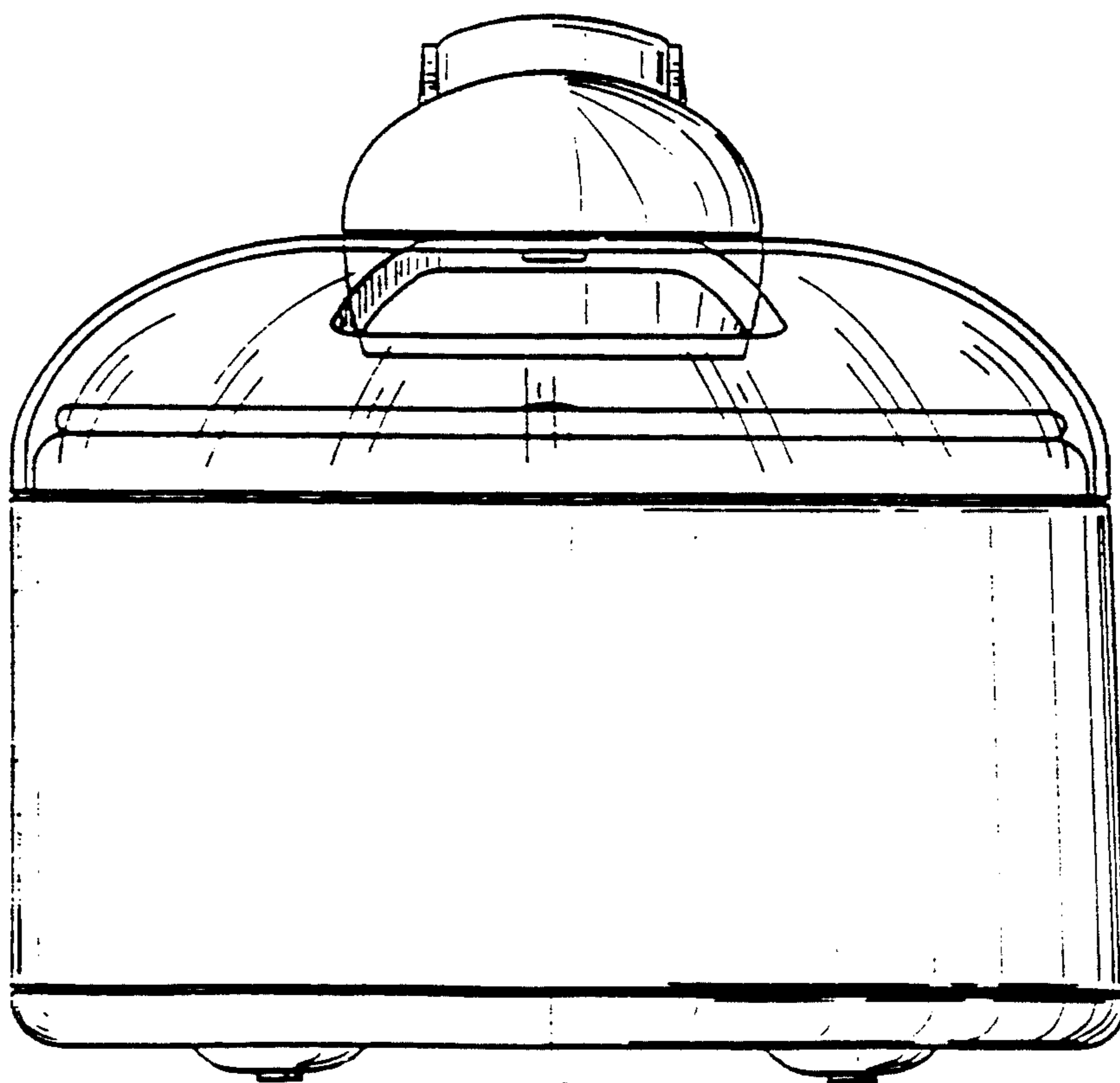

FIG. 5

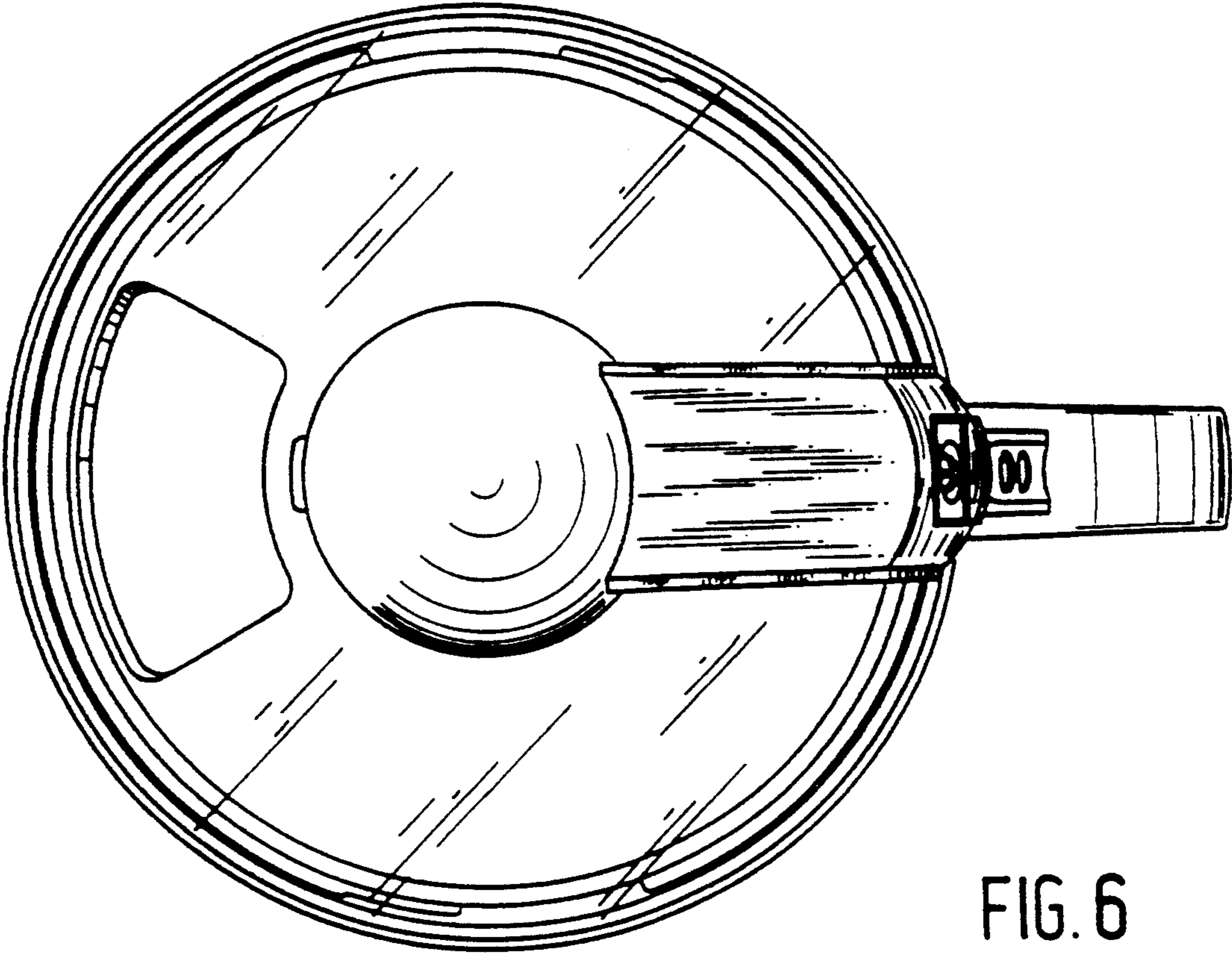

FIG. 6

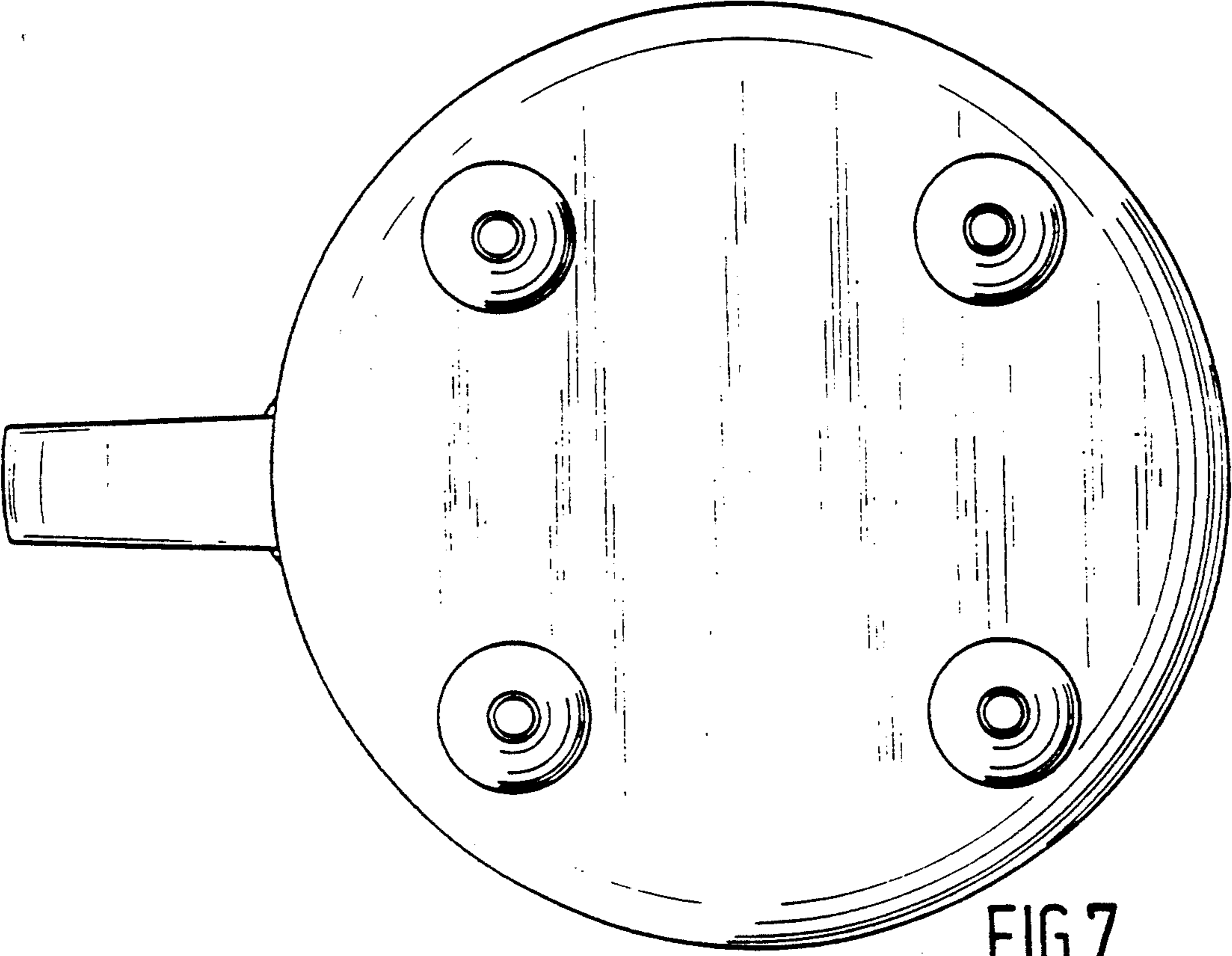

FIG. 7