



US00D346369S

United States Patent [19] Iino

[11] Patent Number: **Des. 346,369**
[45] Date of Patent: **** Apr. 26, 1994**

[54] **ELECTRONIC COMPUTER**
[75] Inventor: **Masaaki Iino**, Yokohama, Japan
[73] Assignee: **Kabushiki Kaisha Toshiba**,
Kanagawa, Japan
[**] Term: **14 Years**
[21] Appl. No.: **844,685**
[22] Filed: **Feb. 28, 1992**

D. 337,100 7/1993 Iino D14/106

Primary Examiner—Wallace R. Burke
Assistant Examiner—Freda S. Nunn
Attorney, Agent, or Firm—Banner, Birch, McKie & Beckett

[57] CLAIM

The ornamental design for an electronic computer, as shown and described.

DESCRIPTION

FIG. 1 is a top, front and right side perspective view of an electronic computer showing my new design; FIG. 2 is a front elevational view thereof; FIG. 3 is a top plan view thereof; FIG. 4 is a left side elevational view thereof; FIG. 5 is a rear elevational view thereof; FIG. 6 is a bottom plan view thereof; FIG. 7 is a front elevational view thereof in closed position; FIG. 8 is a top plan view thereof in closed position; and, FIG. 9 is a right side elevational view thereof in closed position.

[30] **Foreign Application Priority Data**
Aug. 30, 1991 [JP] Japan 3-25833
[52] U.S. Cl. **D14/106**
[58] **Field of Search** 340/700, 706; 341/22,
341/23; 364/708, 709.04, 709.12; 361/390, 394;
D14/100, 101, 106, 113, 115; D18/1, 7, 11, 12
[56] **References Cited**
U.S. PATENT DOCUMENTS
D. 335,124 4/1993 Mizusugi et al. D14/106
D. 335,870 5/1993 Yun D14/106

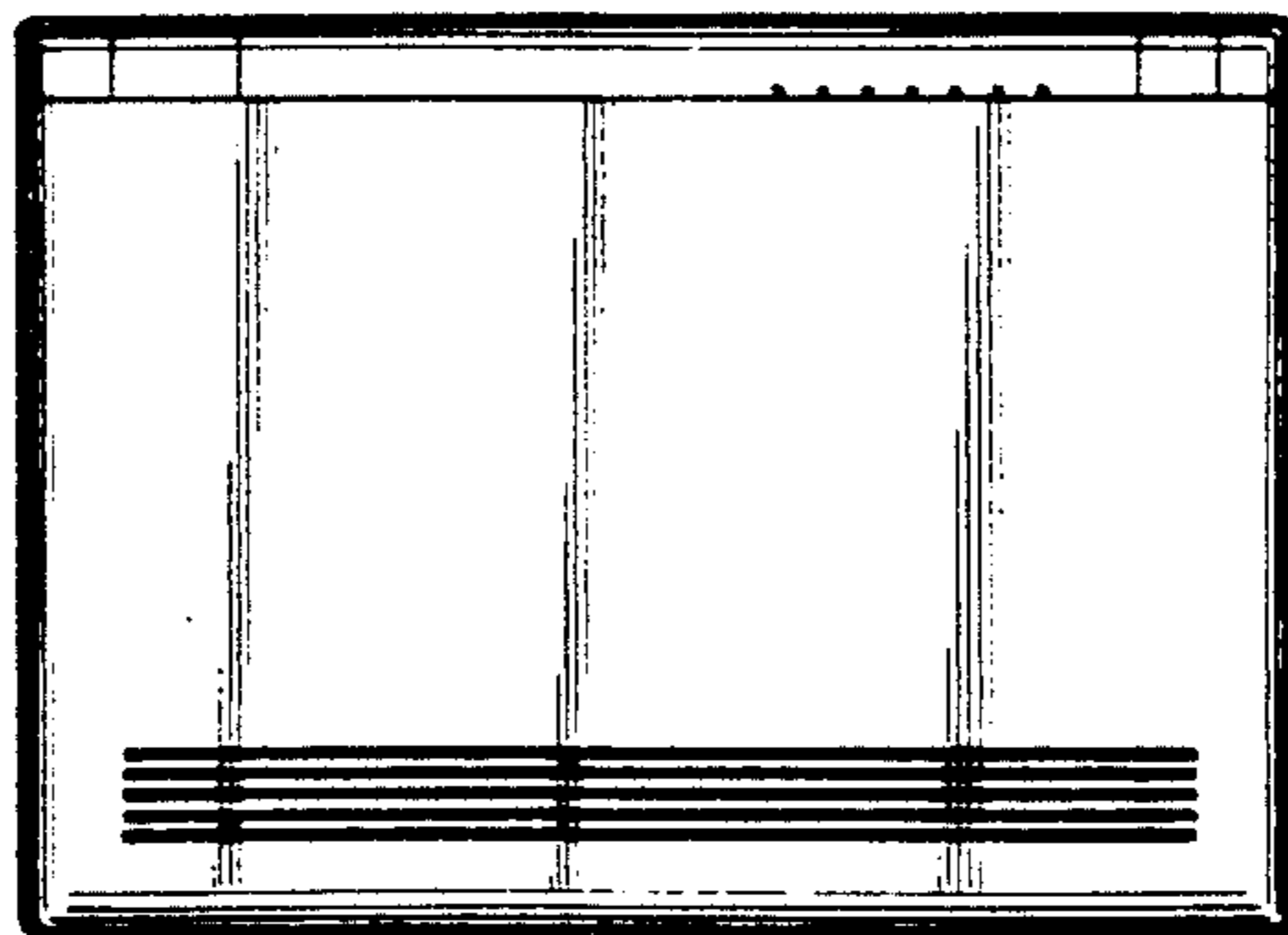
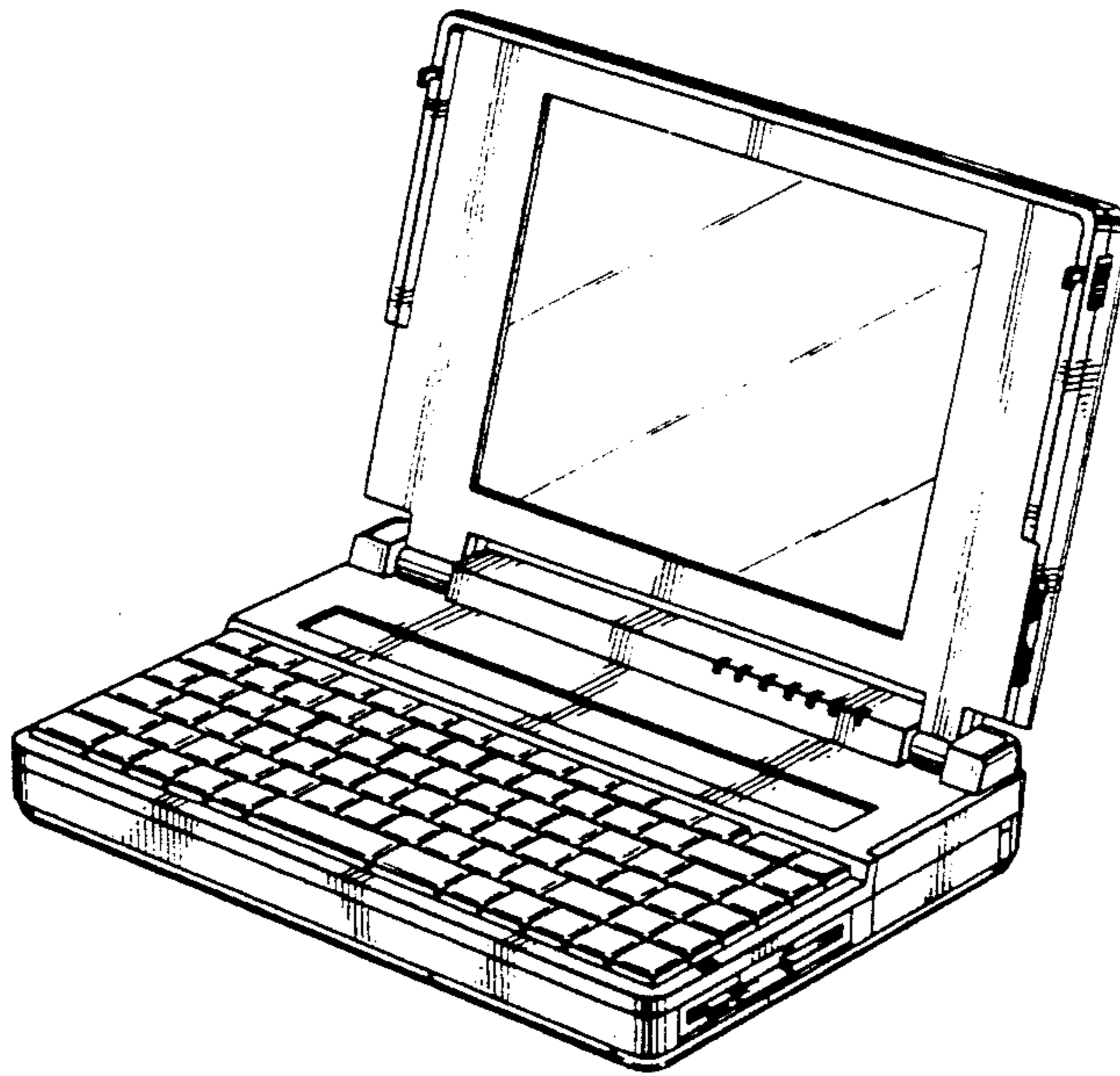

FIG. 1

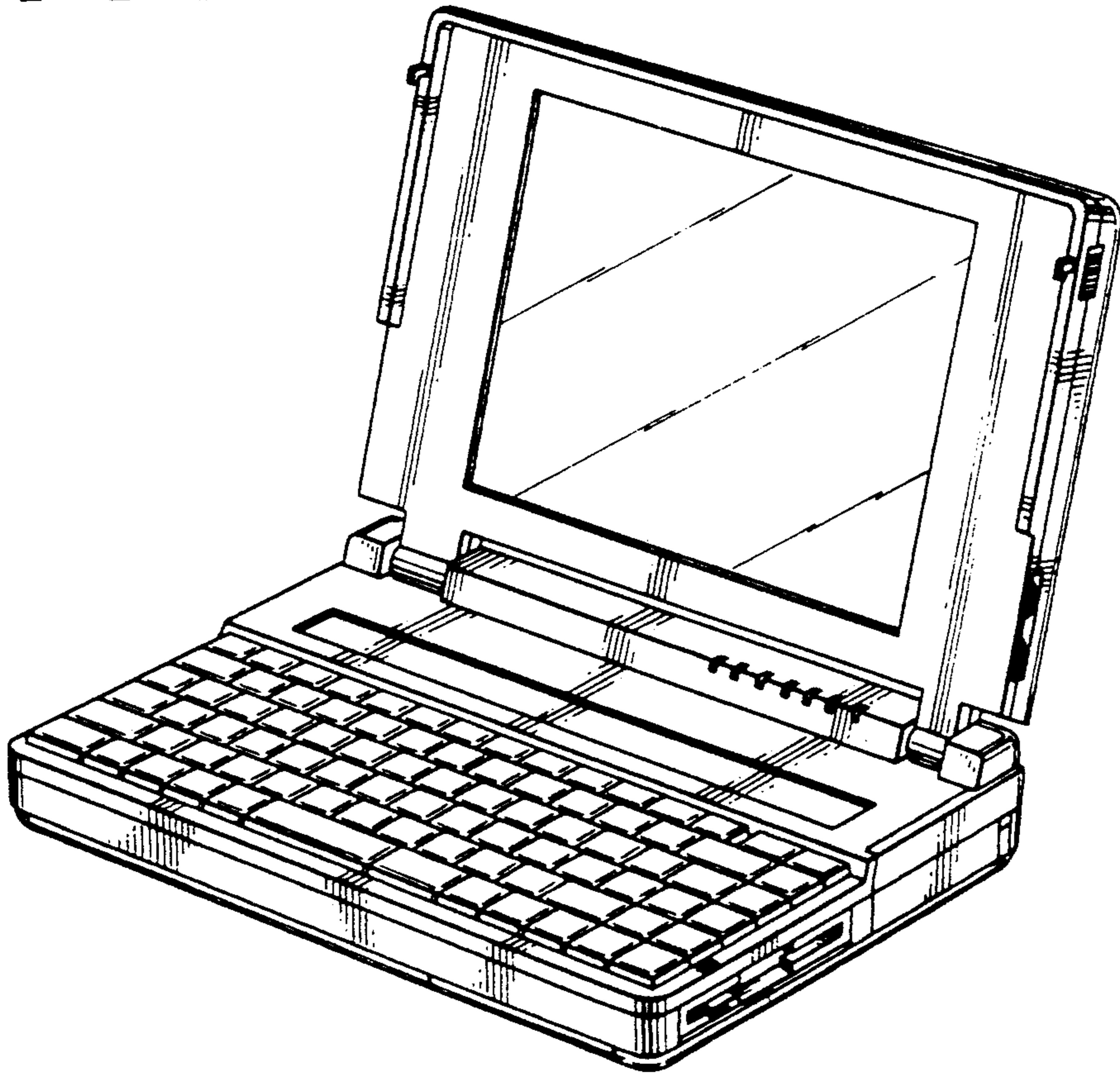

FIG. 2

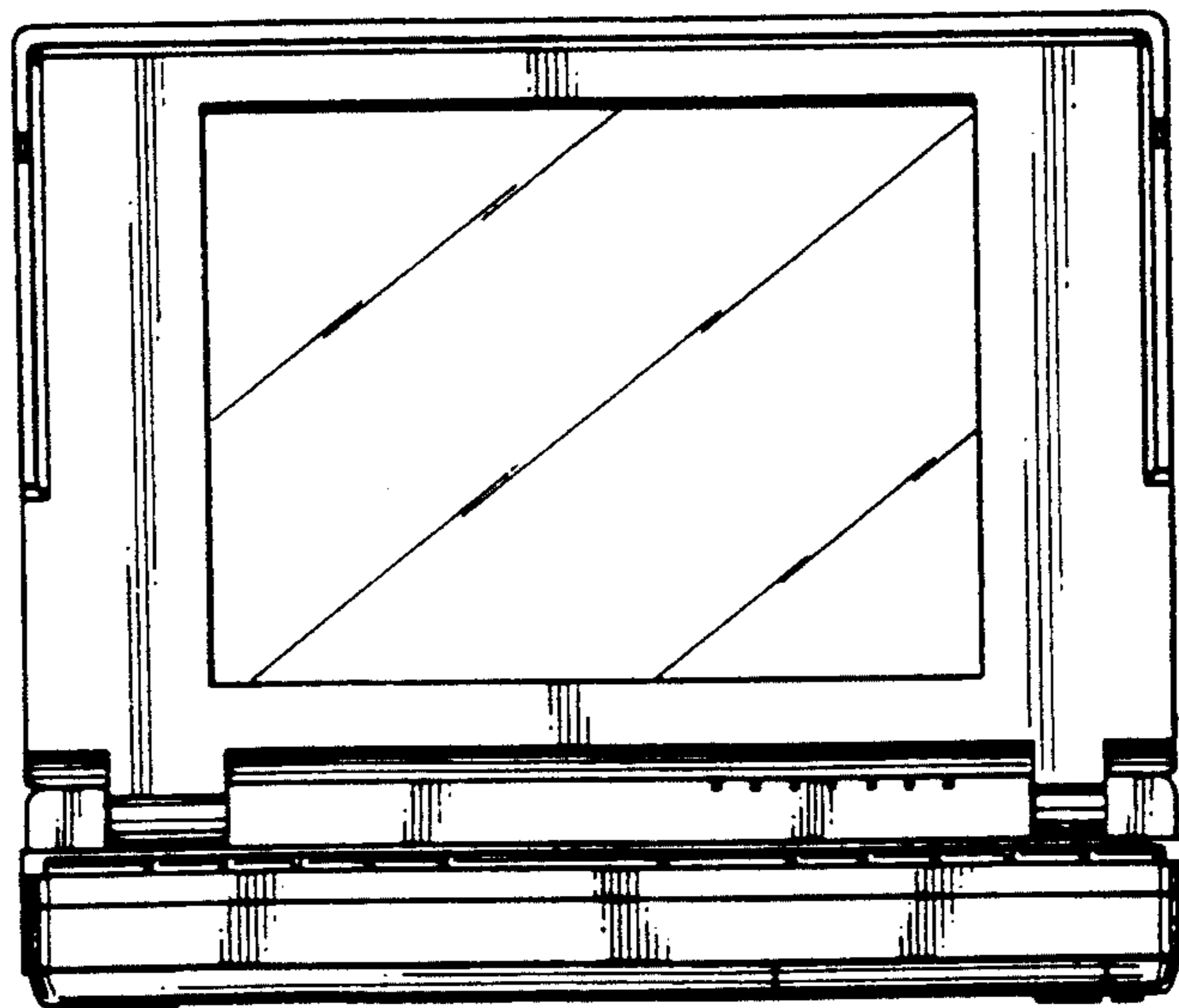

FIG.3

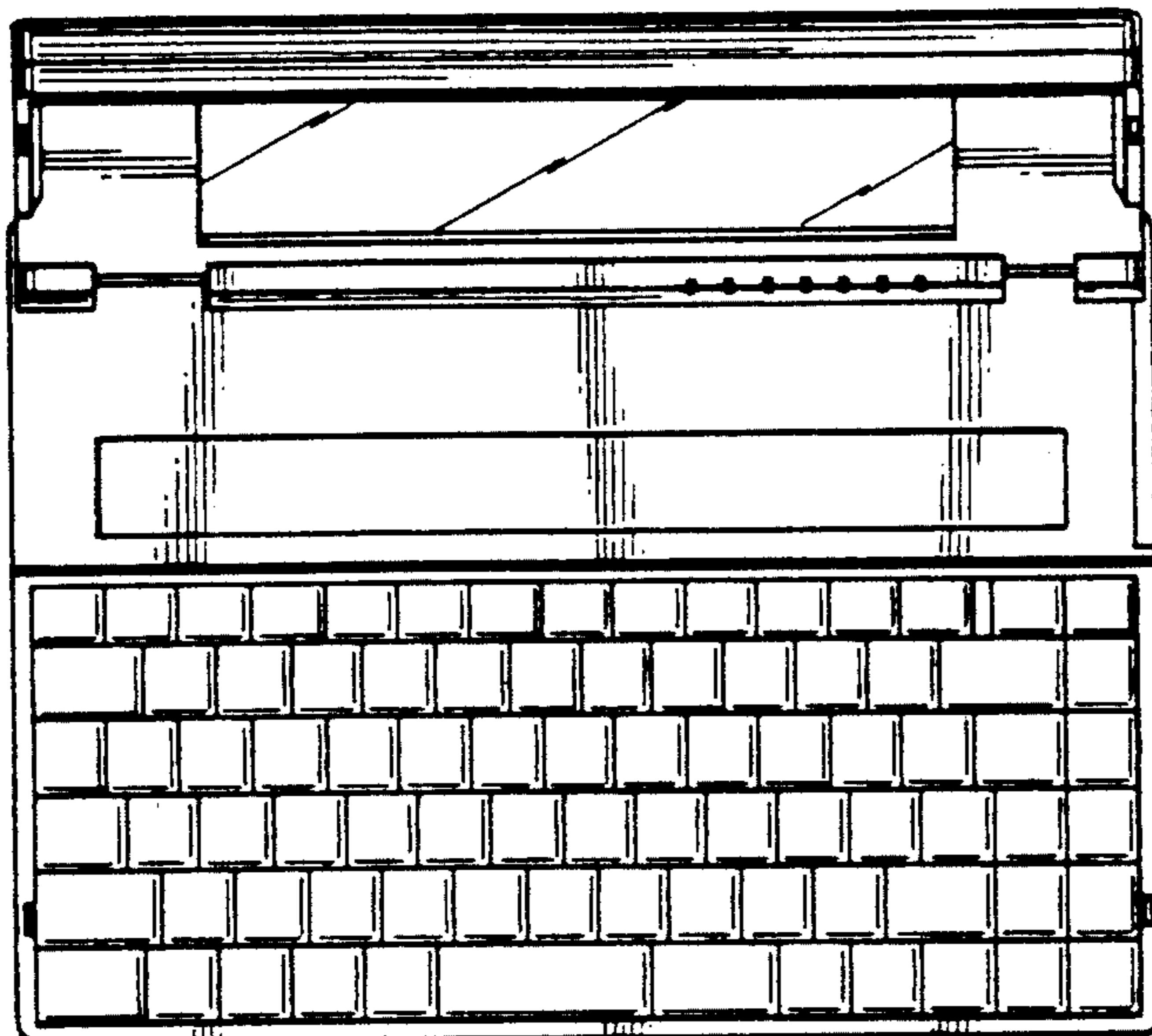

FIG.4

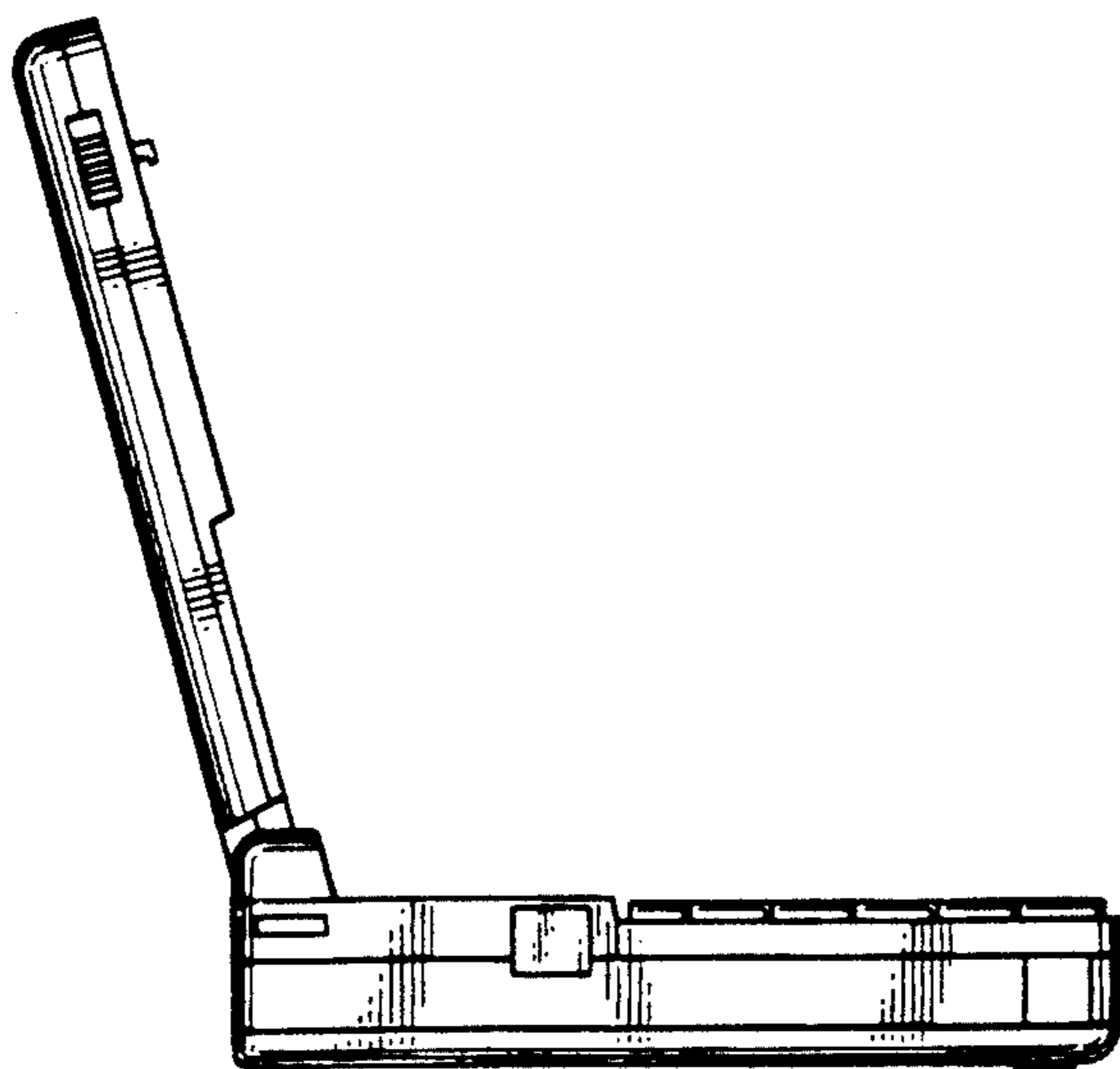

FIG. 5

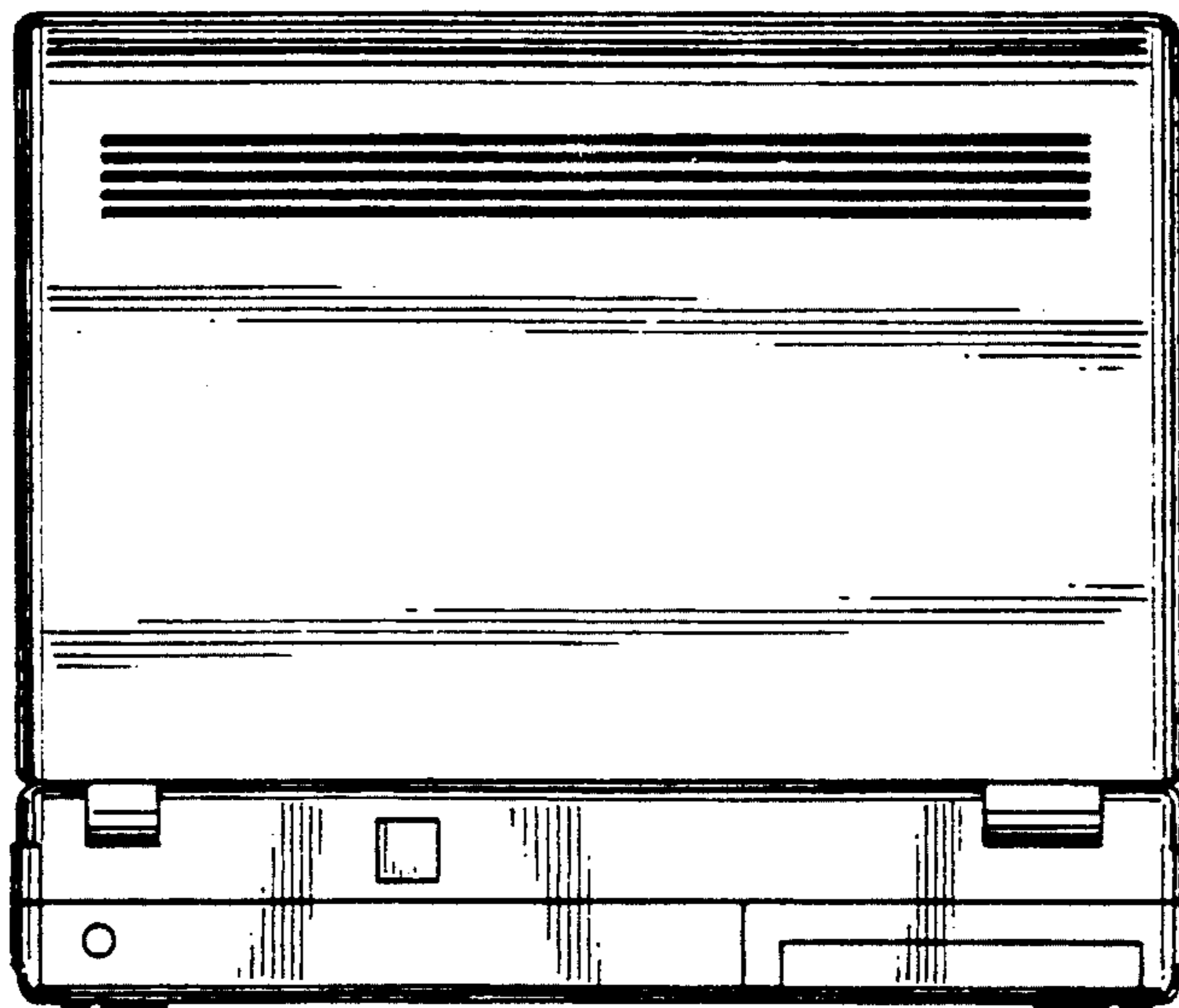

FIG. 6

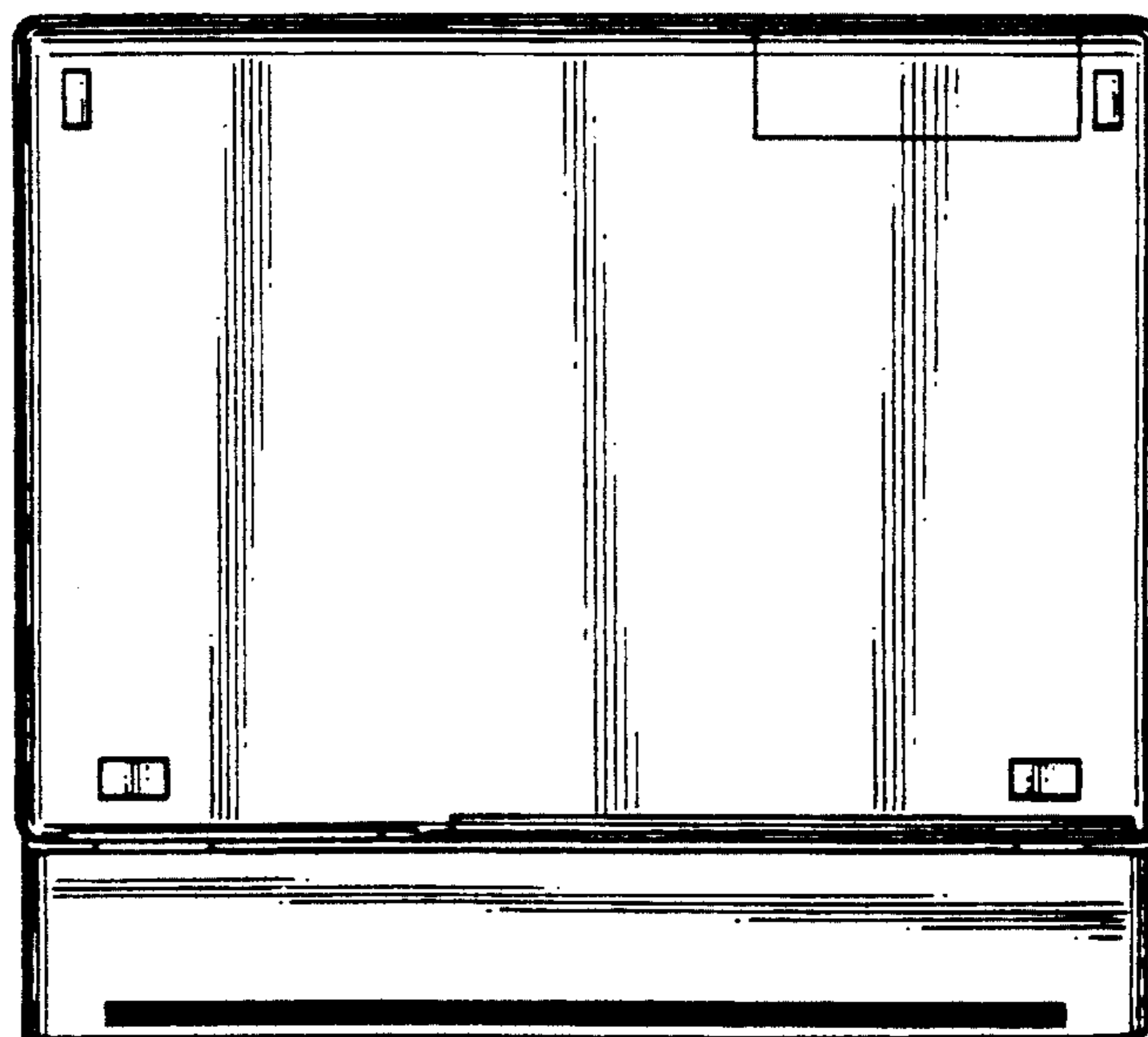

FIG. 7

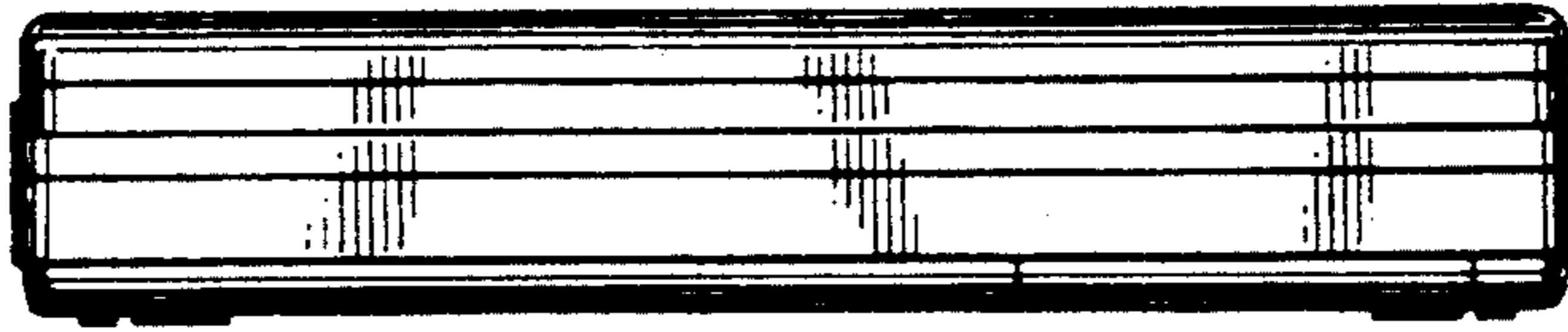

FIG. 8

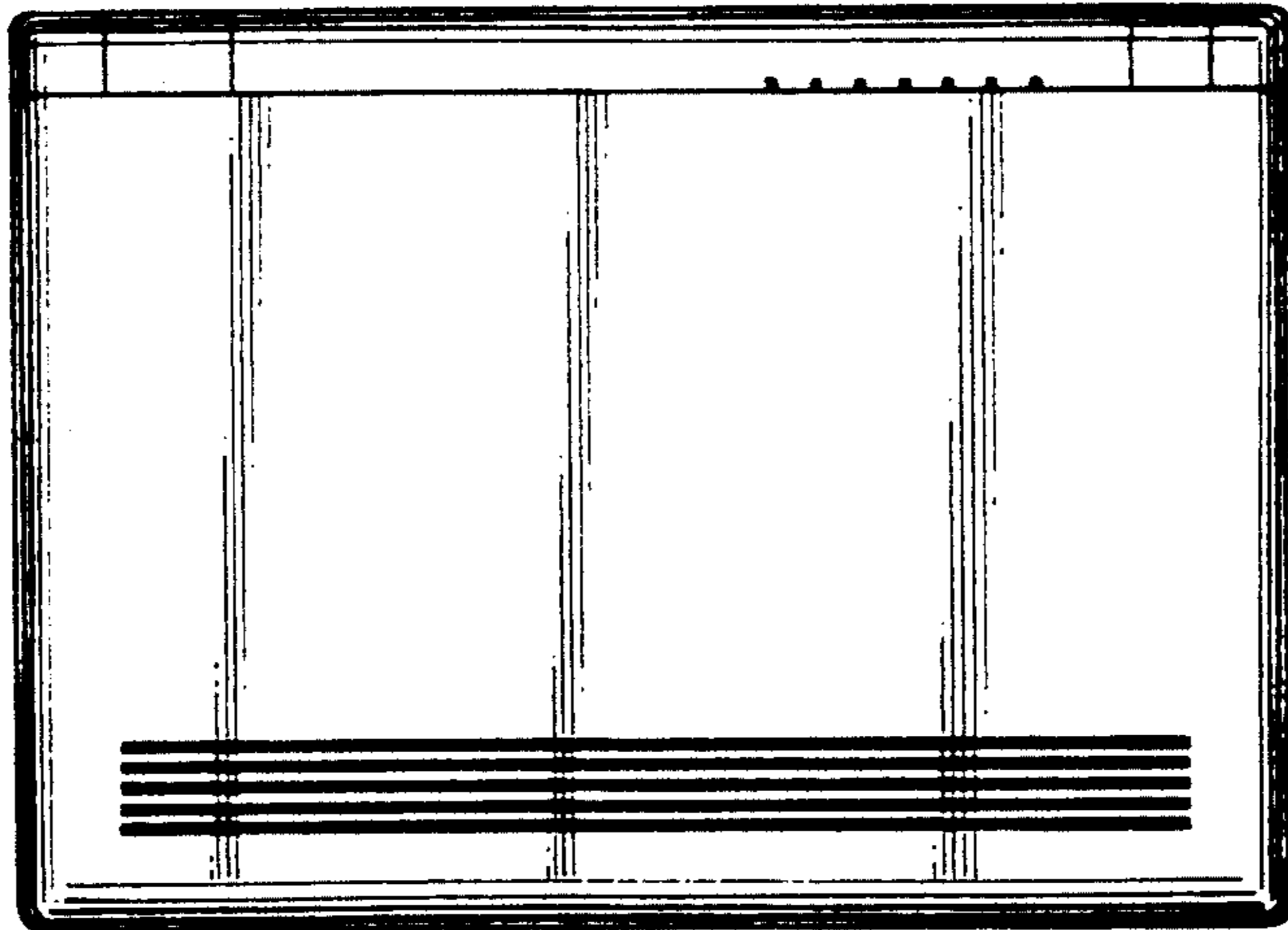

FIG. 9

