



US00D346305S

United States Patent [19]

[11] Patent Number: **Des. 346,305**

Breeka

[45] Date of Patent: **** Apr. 26, 1994**

[54] **ALL-PURPOSE FOOD STEAMER**

D. 323,424 1/1992 Beiler et al. D7/357
2,895,405 7/1959 Hopkins D7/354 X

[75] Inventor: **Paul E. Breeka**, Southborough, Mass.

OTHER PUBLICATIONS

[73] Assignee: **Creative Technologies Corp.**, Brooklyn, N.Y.

Better Homes & Gardens; Nov. 1973, p. 215; Yogurt Maker.

[*] Notice: The portion of the term of this patent subsequent to Jan. 28, 2006 has been disclaimed.

Primary Examiner—Alan P. Douglas
Assistant Examiner—Caron D. Veynar
Attorney, Agent, or Firm—Helfgott & Karas

[**] Term: **14 Years**

[57] **CLAIM**

[21] Appl. No.: **758,812**

The ornamental design for a all-purpose food steamer, as shown.

[22] Filed: **Sep. 12, 1991**

[52] U.S. Cl. **D7/357; D7/323**

DESCRIPTION

[58] Field of Search **D7/323, 347, 357; D9/341; 99/336, 341, 403, 410, 415, 440**

FIG. 1 is a perspective view of the all-purpose food steamer;

[56] **References Cited**

U.S. PATENT DOCUMENTS

D. 261,594 11/1981 Boldt et al. D7/360
D. 262,355 12/1981 Oakley D9/424 X
D. 317,548 6/1991 Yeh D7/357

FIG. 2 is a top view thereof;
FIG. 3 is a front view thereof;
FIG. 4 is a right view thereof; the left view being identical thereon;

FIG. 5 is a rear view thereof; and,
FIG. 6 is a bottom view thereof.

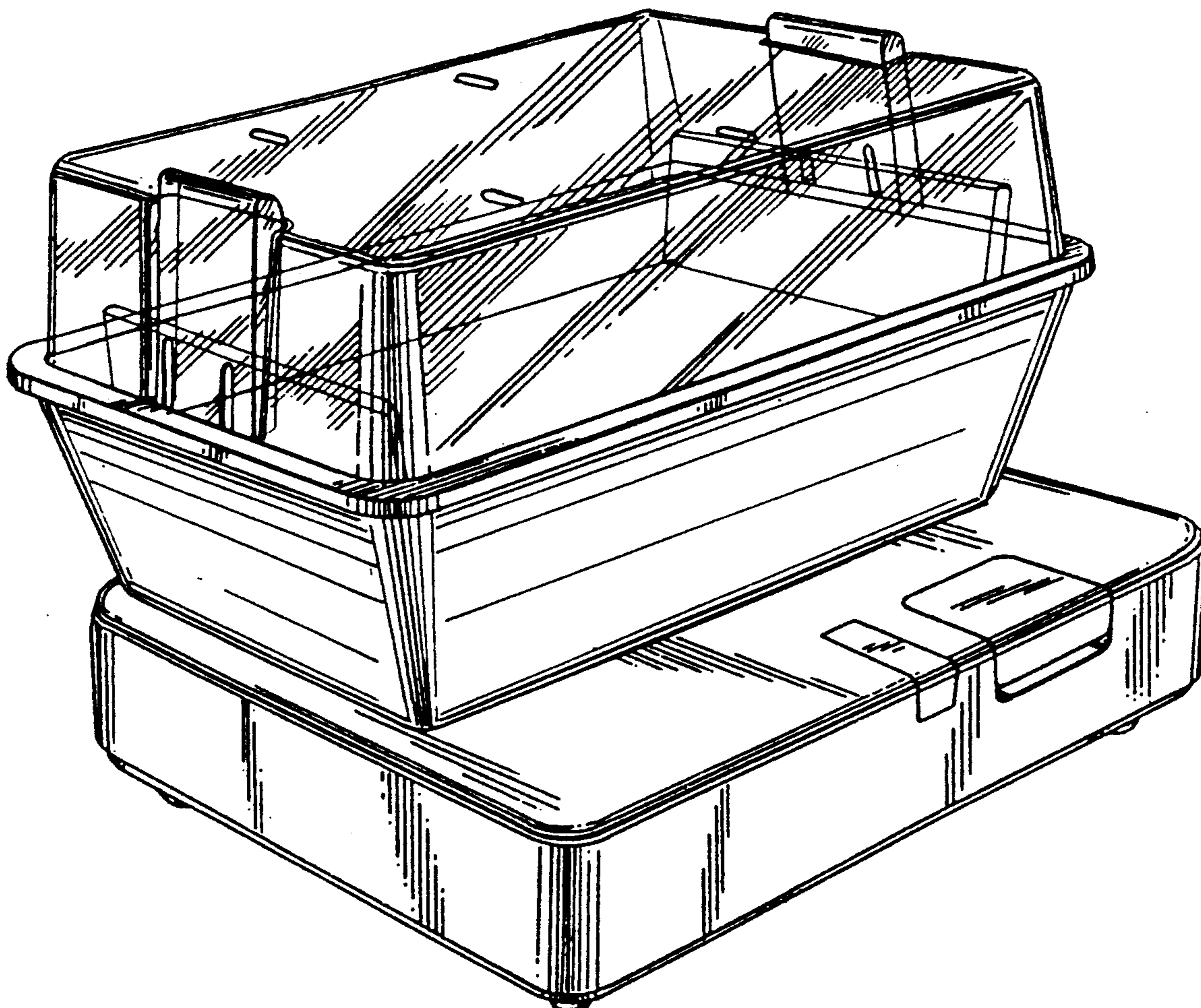

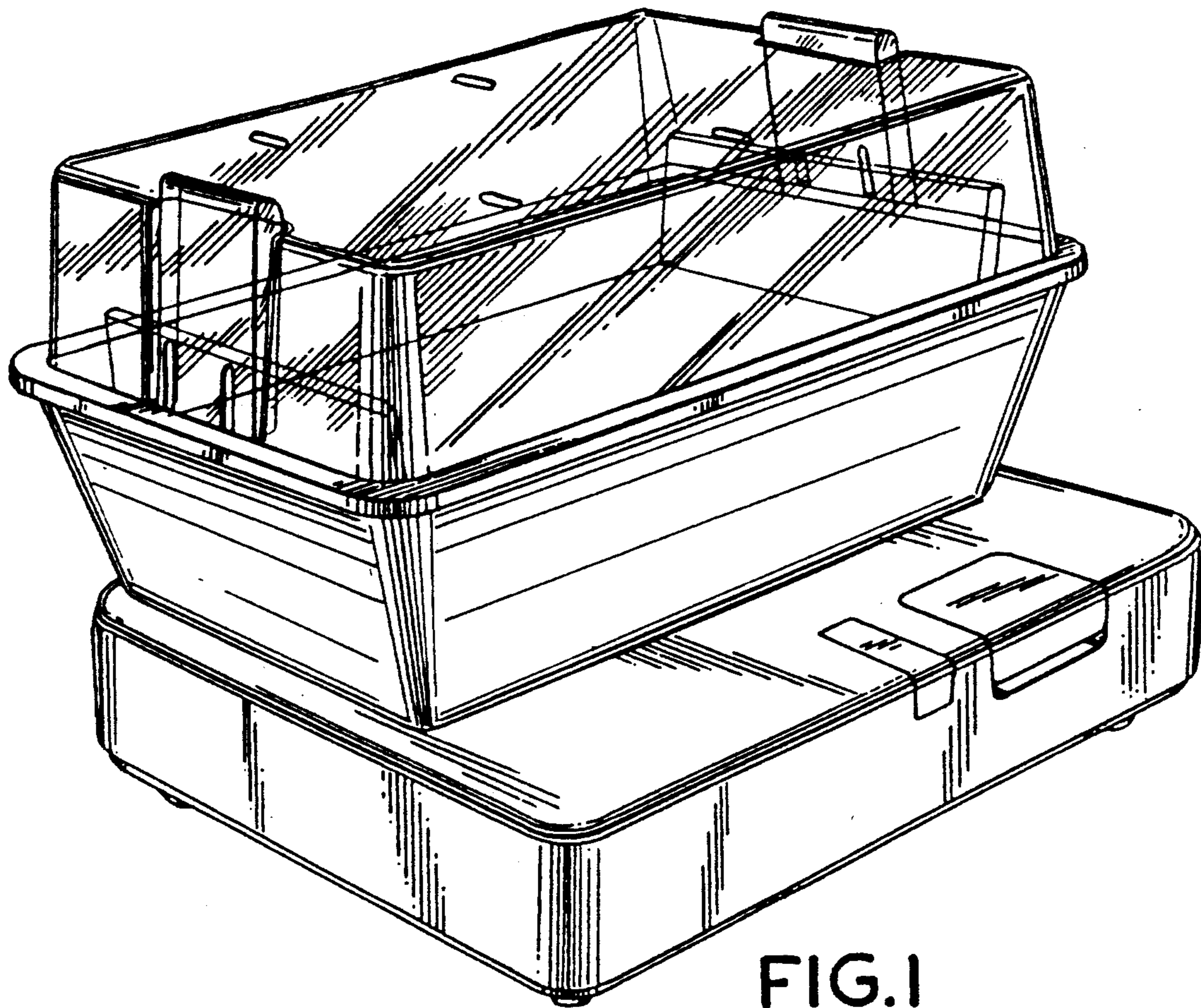

FIG. 1

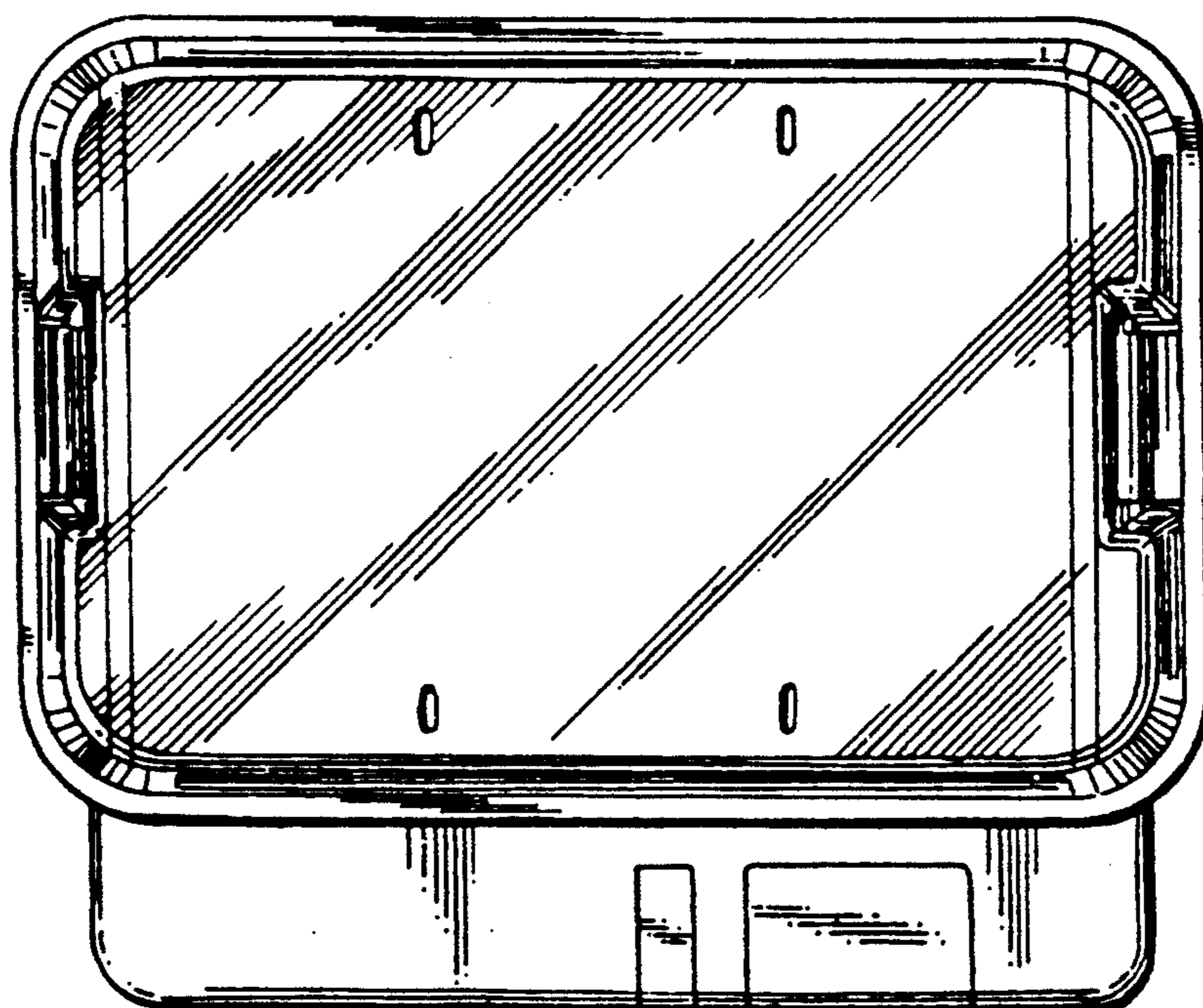

FIG. 2

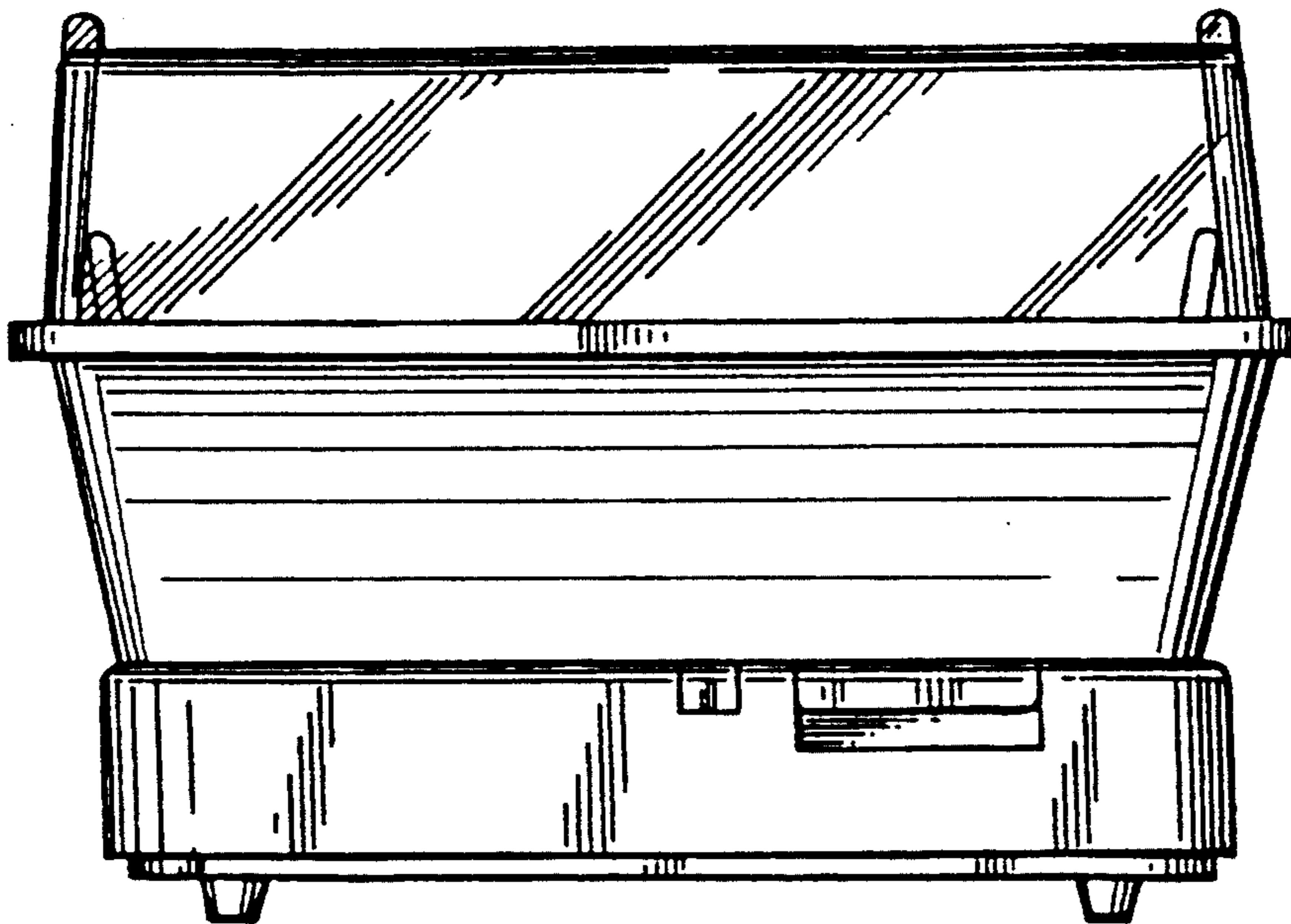

FIG. 3

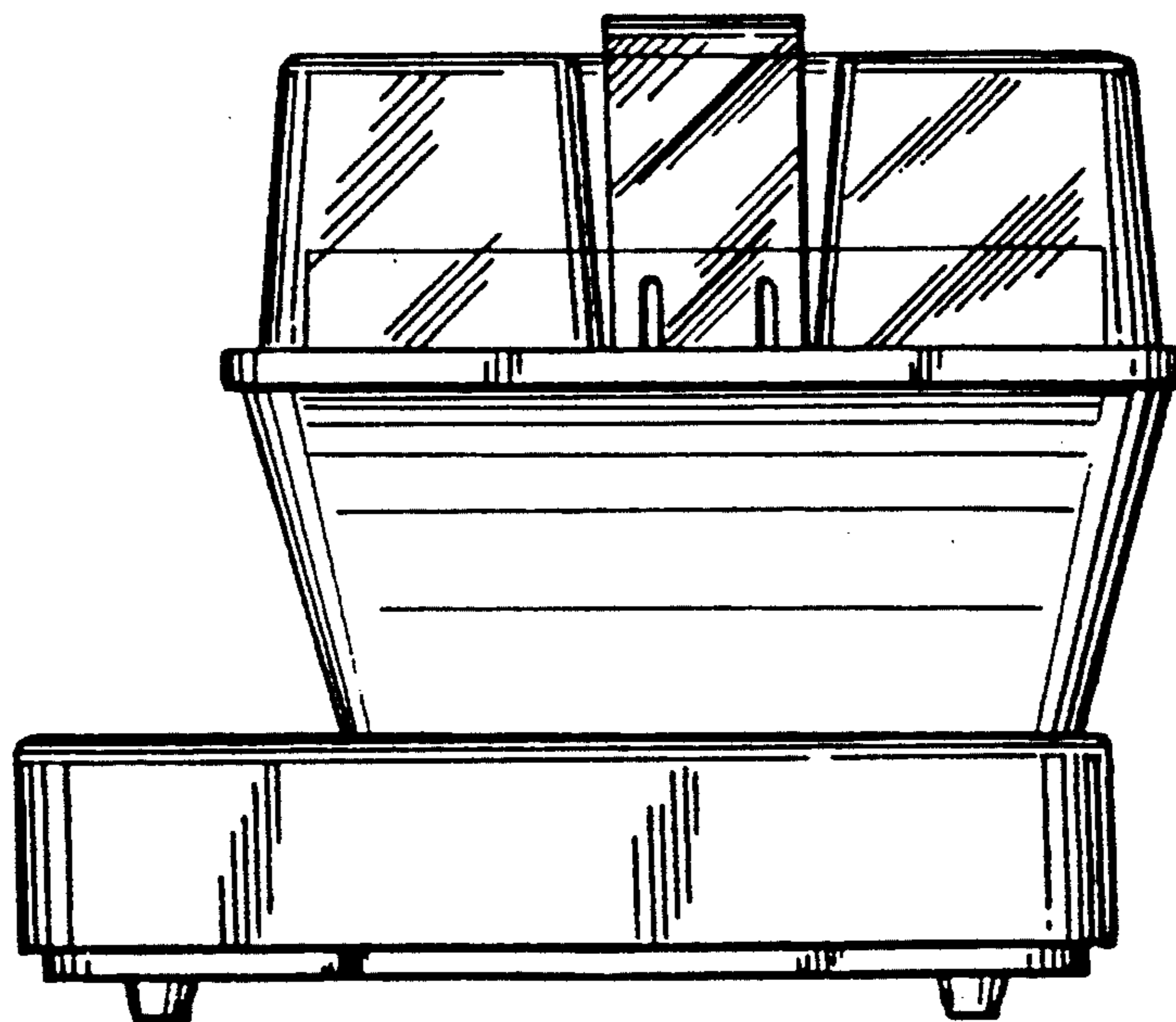

FIG. 4

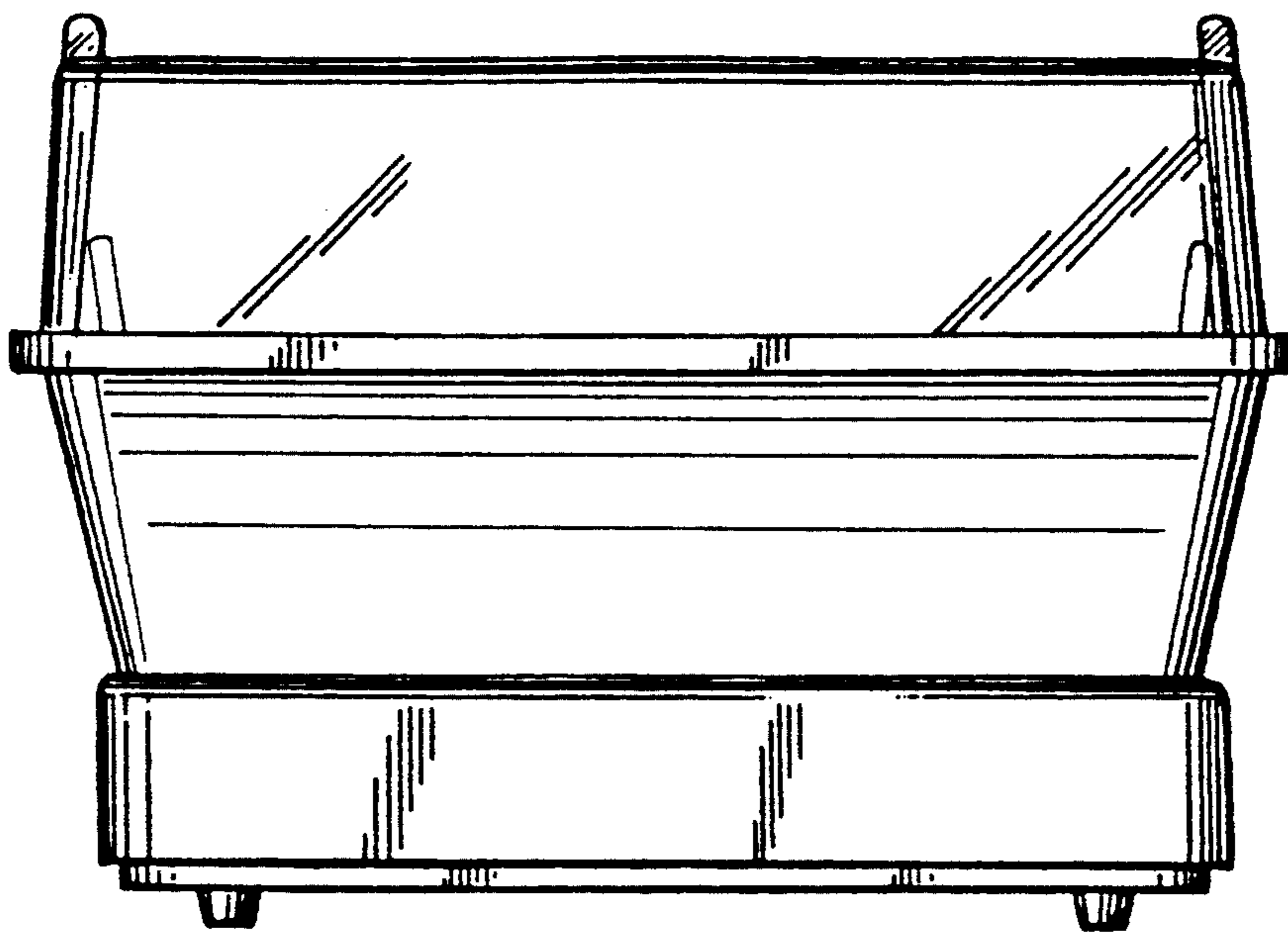

FIG. 5

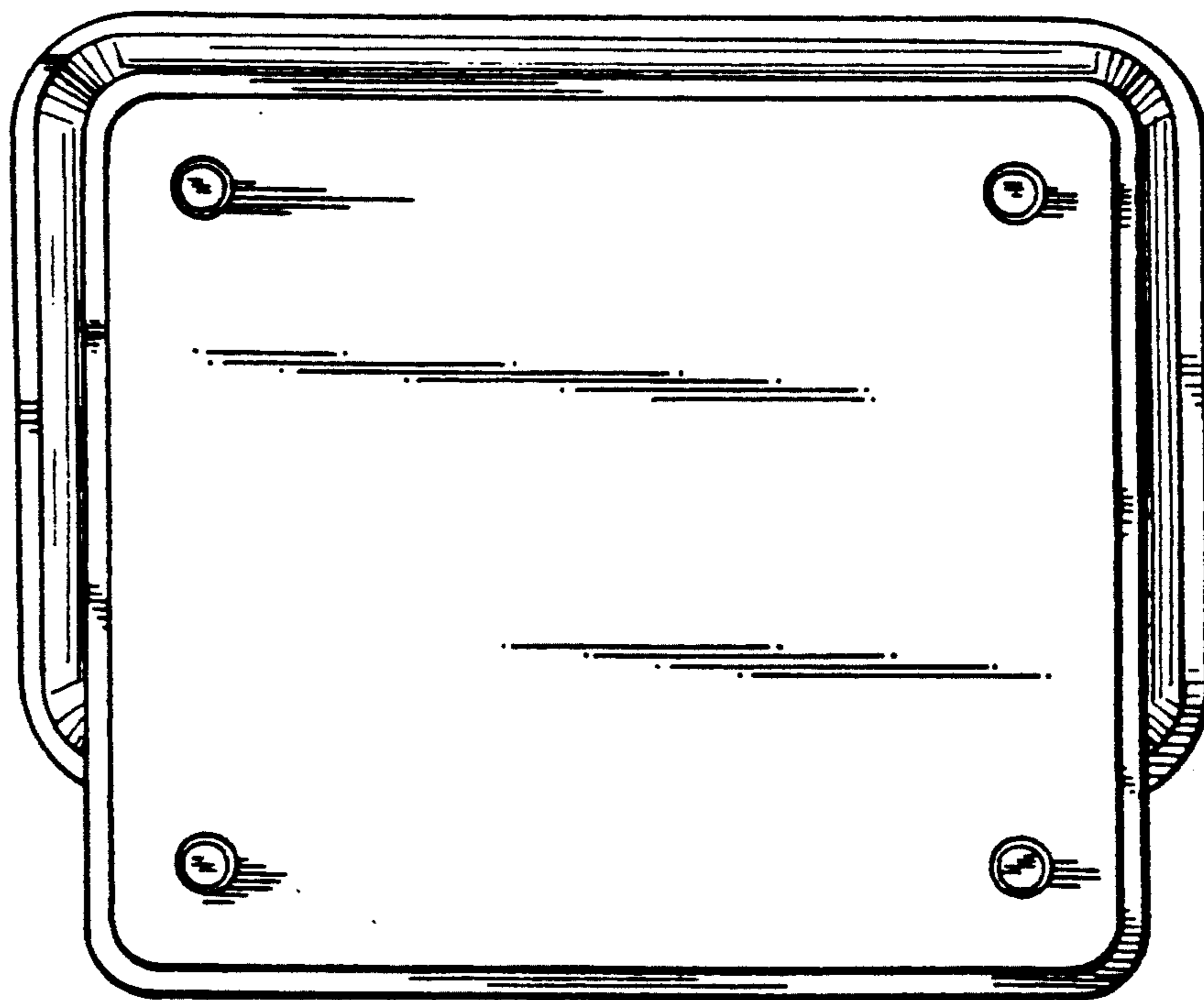

FIG. 6