



US00D346299S

# United States Patent [19]

[11] Patent Number: **Des. 346,299**

Covault et al.

[45] Date of Patent: **\*\* Apr. 26, 1994**

[54] **JUG**

[57] **CLAIM**

[75] Inventors: **Andrew Covault; Timothy M. Holub; Regis Schulte; Mick Whelan**, all of Wichita, Kans.

The ornamental design for a jug, as shown and described.

[73] Assignee: **The Coleman Company, Inc.**, Wichita, Kans.

### DESCRIPTION

[\*\*] Term: **14 Years**

FIG. 1 is a front elevational view of a jug showing our new design;

[21] Appl. No.: **923**

FIG. 2 is a right side elevational view thereof, the opposite side being a mirror image;

[22] Filed: **Nov. 6, 1992**

FIG. 3 is a rear elevational view thereof;

[52] U.S. Cl. .... **D7/312; D7/300; D7/608**

FIG. 4 is a top plan view thereof;

[58] Field of Search ..... **D7/300, 310, 312-313, D7/317-318, 319, 321, 605, 608; 62/457.1, 457.4, 372; 220/754; 224/148**

FIG. 5 is a bottom plan view thereof;

FIG. 6 is a fragmentary front elevational view thereof with the cup removed and the pour spout in an open position;

[56] **References Cited**

#### U.S. PATENT DOCUMENTS

- D. 256,652 9/1980 Leung et al. .... D7/608
- D. 334,341 3/1993 Brown et al. .... D7/312 X
- D. 337,232 7/1993 Kahl ..... D7/605

FIG. 7 is a fragmentary right side elevational view of FIG. 6;

FIG. 8 is a top plan view of FIG. 6 the handle shown broken away for ease of illustration;

FIG. 9 is a fragmentary rear elevational view of FIG. 6;

FIG. 10 is a fragmentary front elevational view of FIG. 6 with the pour spout in a closed position;

FIG. 11 is a fragmentary right side elevational view of FIG. 10, the opposite side being a mirror image;

FIG. 12 is a top plan view of FIG. 10;

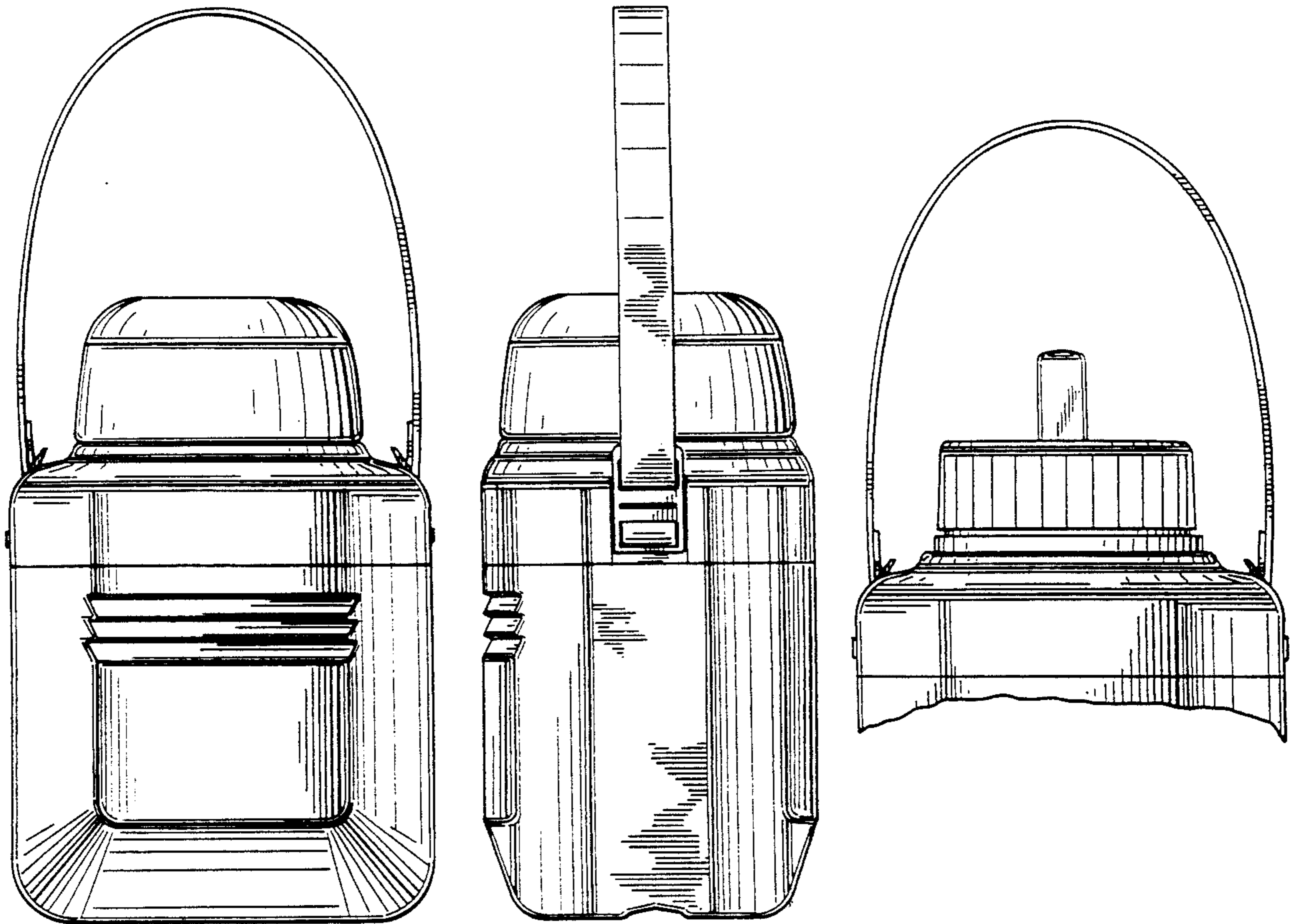
FIG. 13 is a front elevational view of an alternate embodiment of FIG. 1; and,

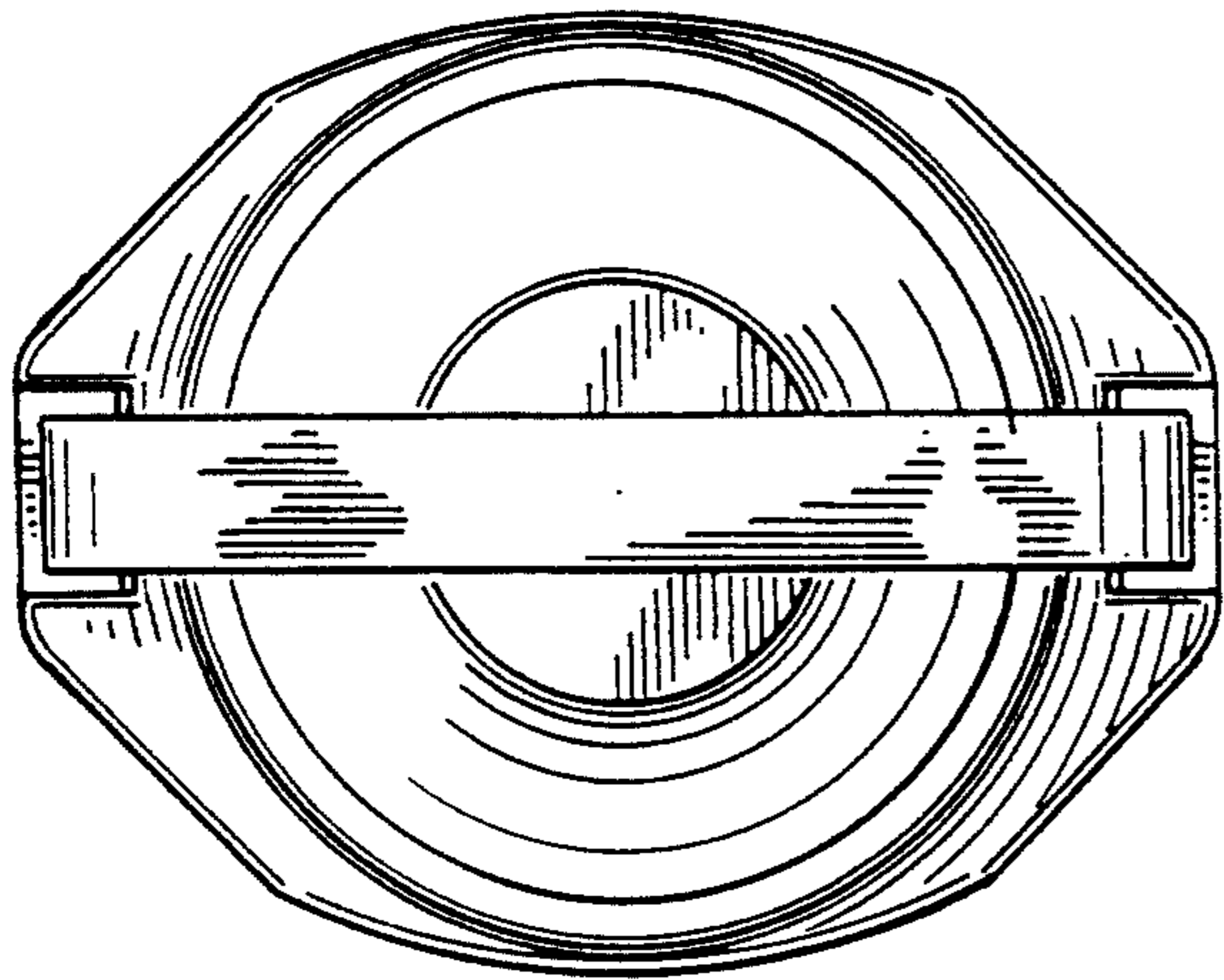
FIG. 14 is a right side elevational view of FIG. 13, the opposite side being a mirror image.

#### OTHER PUBLICATIONS

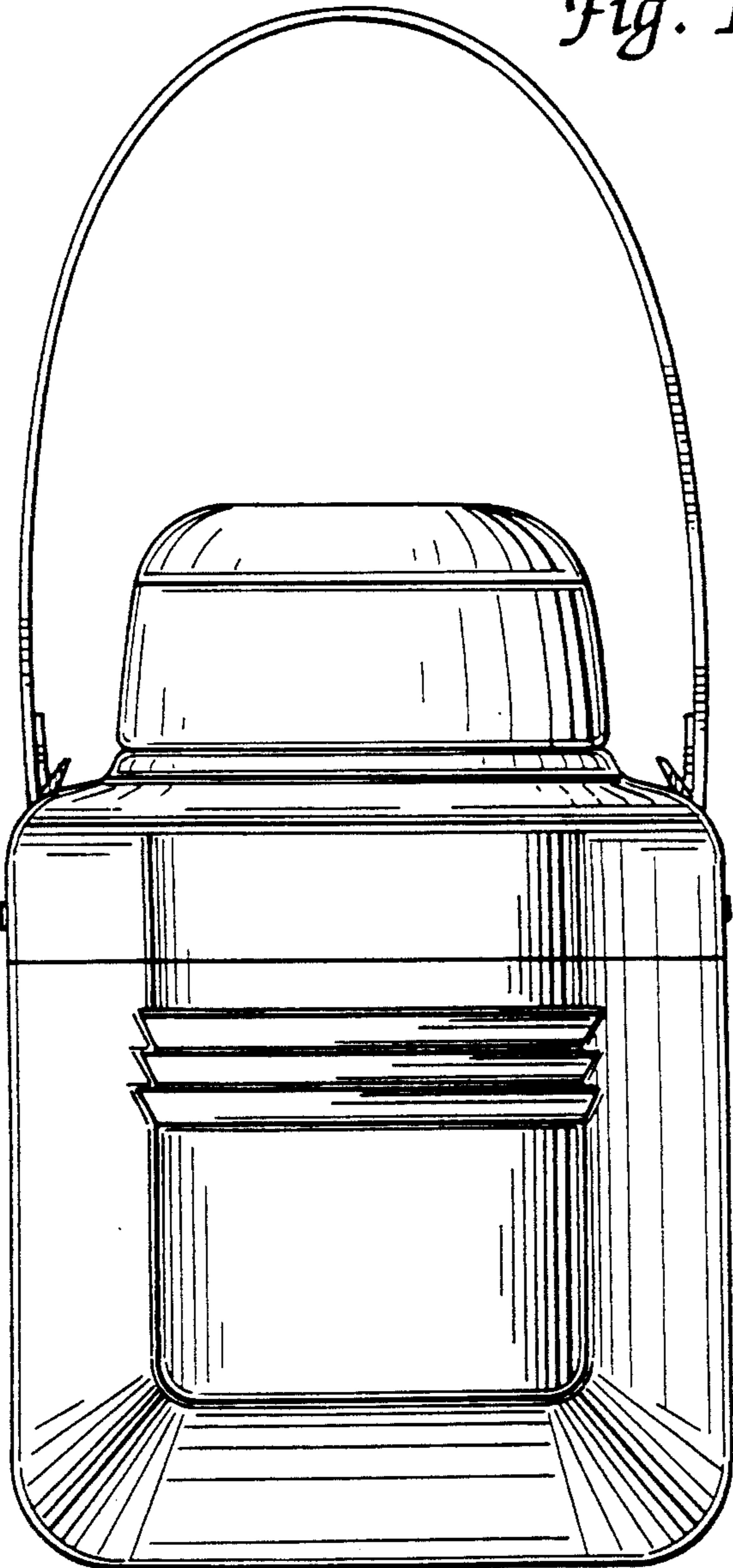
Six photographs of prior art containers with straps.

Primary Examiner—Terry A. Wallace

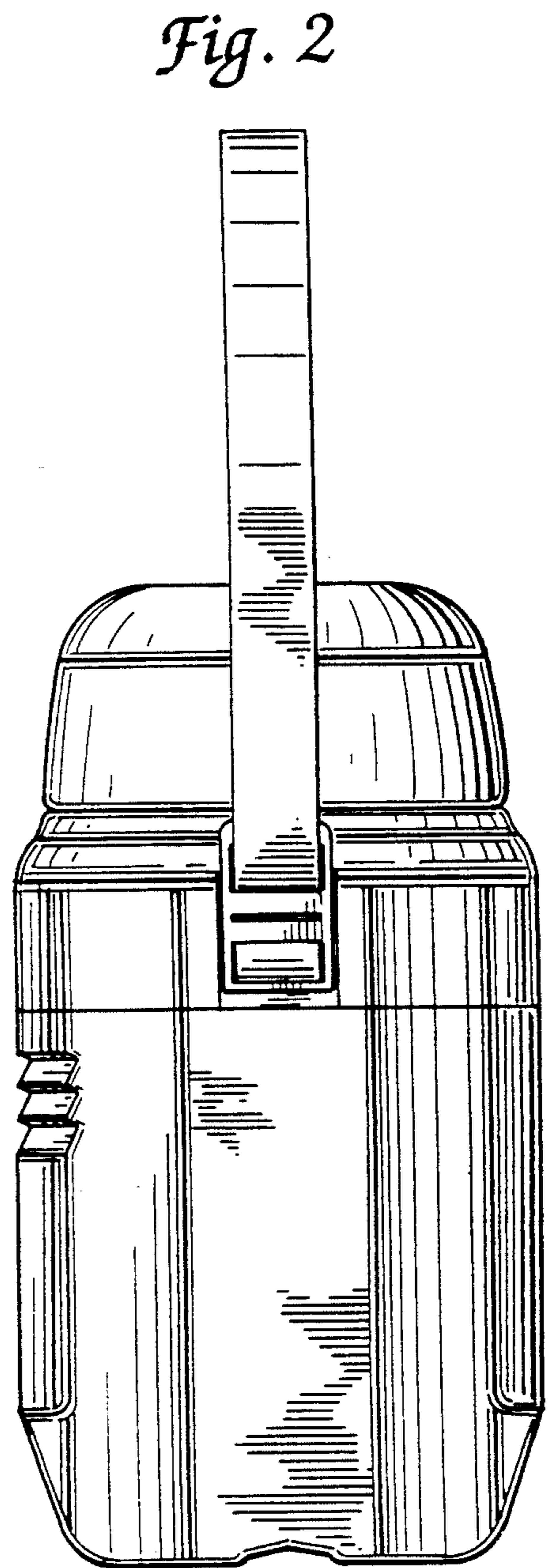




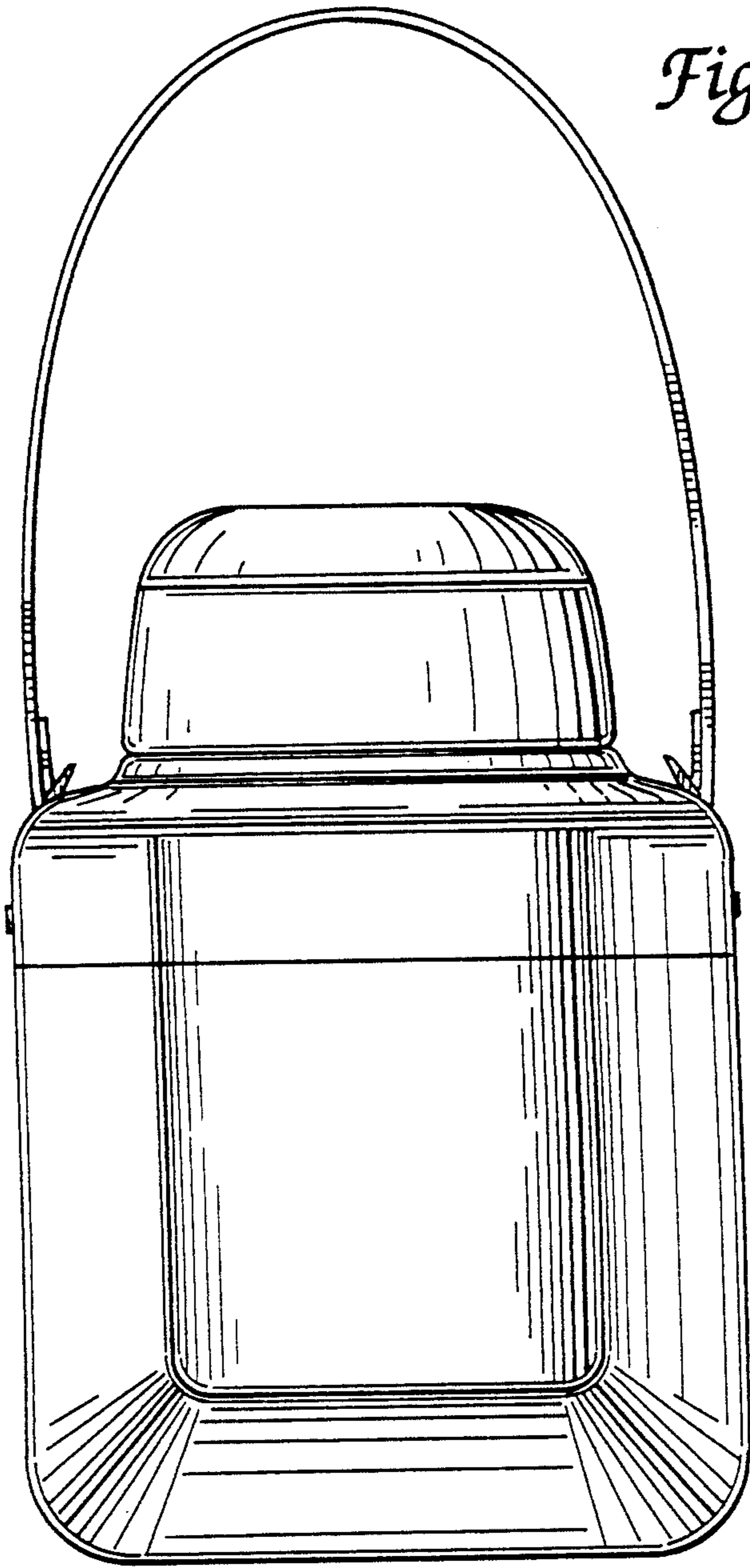
*Fig. 4*



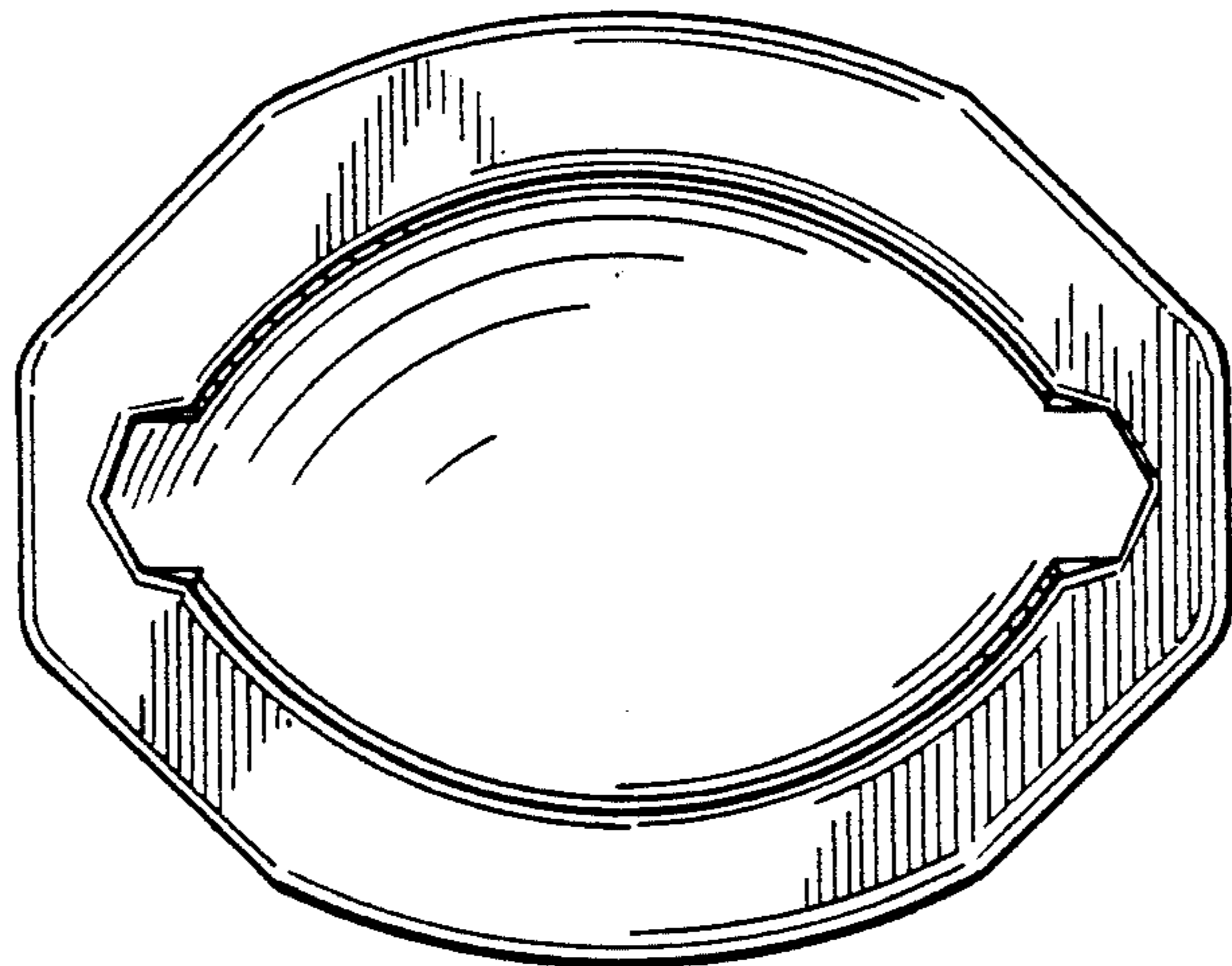
*Fig. 1*



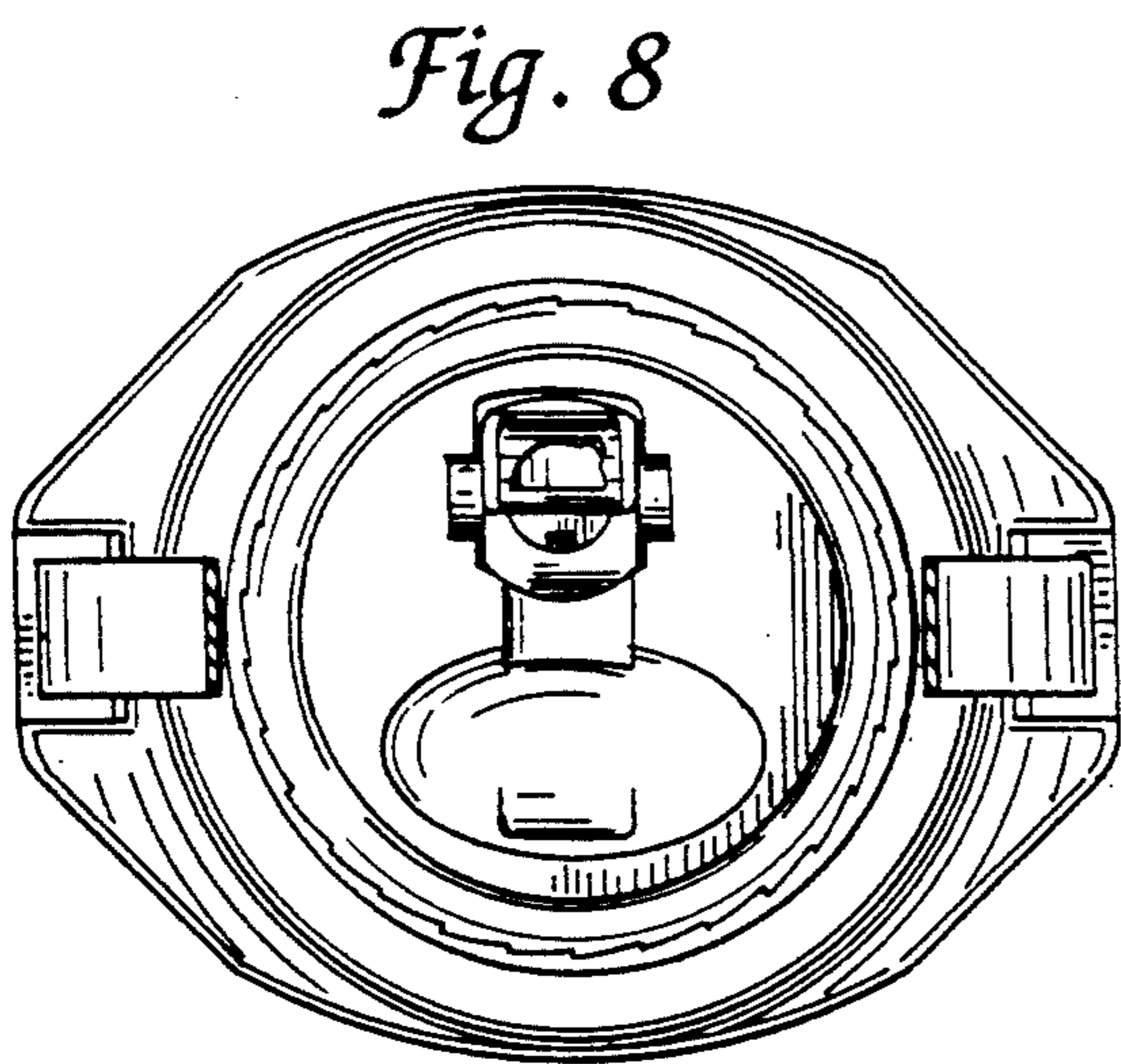
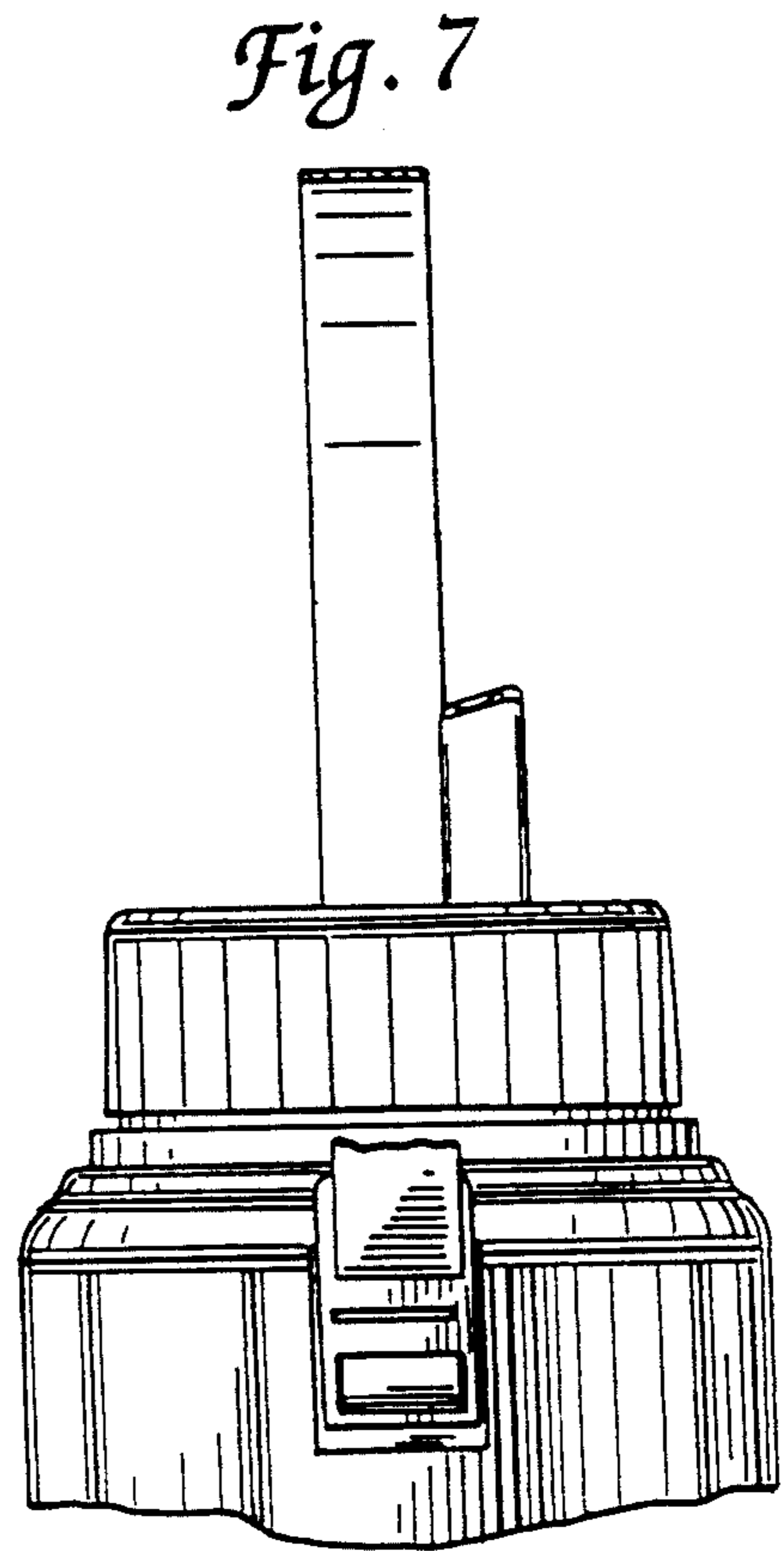
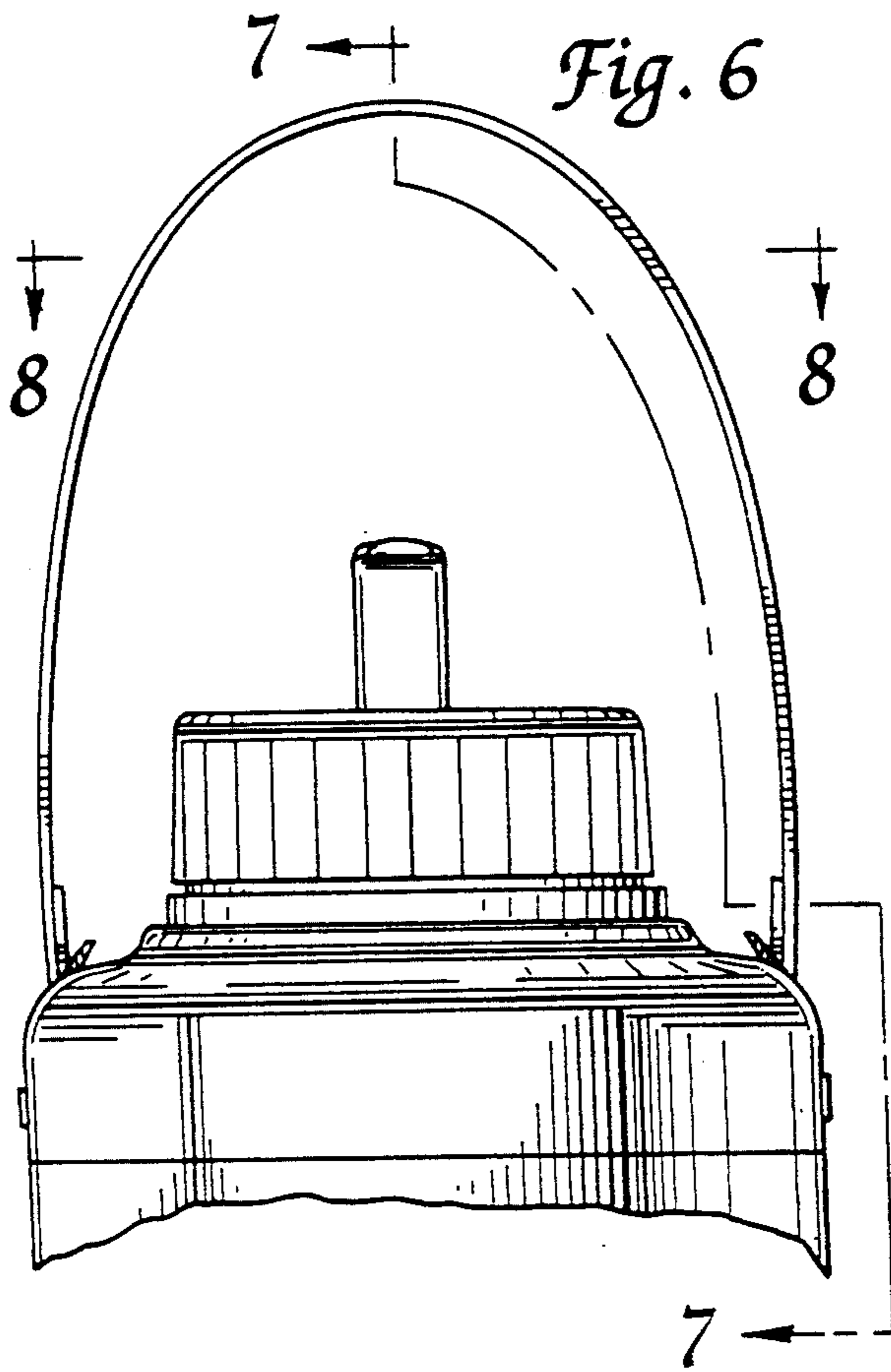
*Fig. 2*



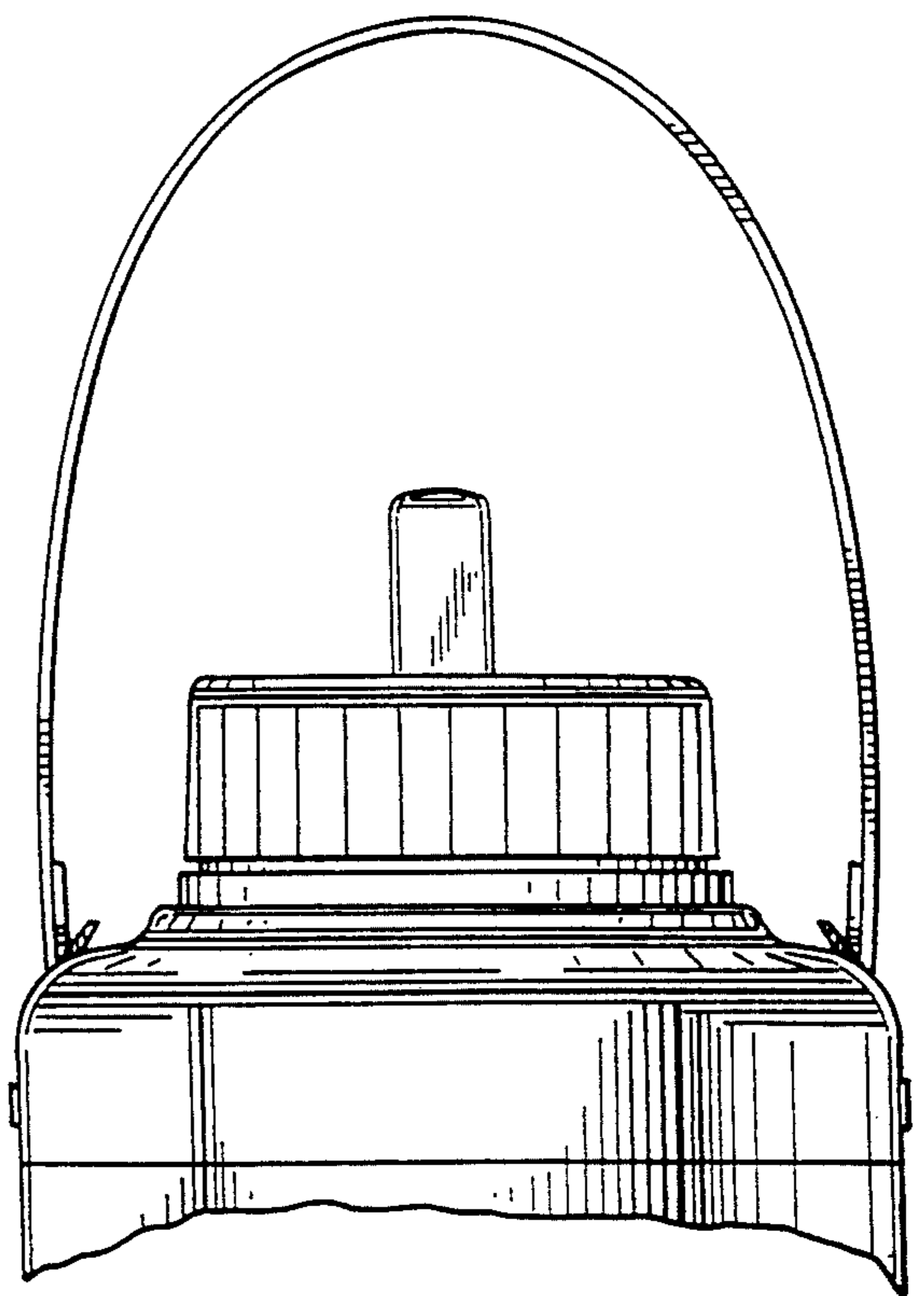
*Fig. 3*



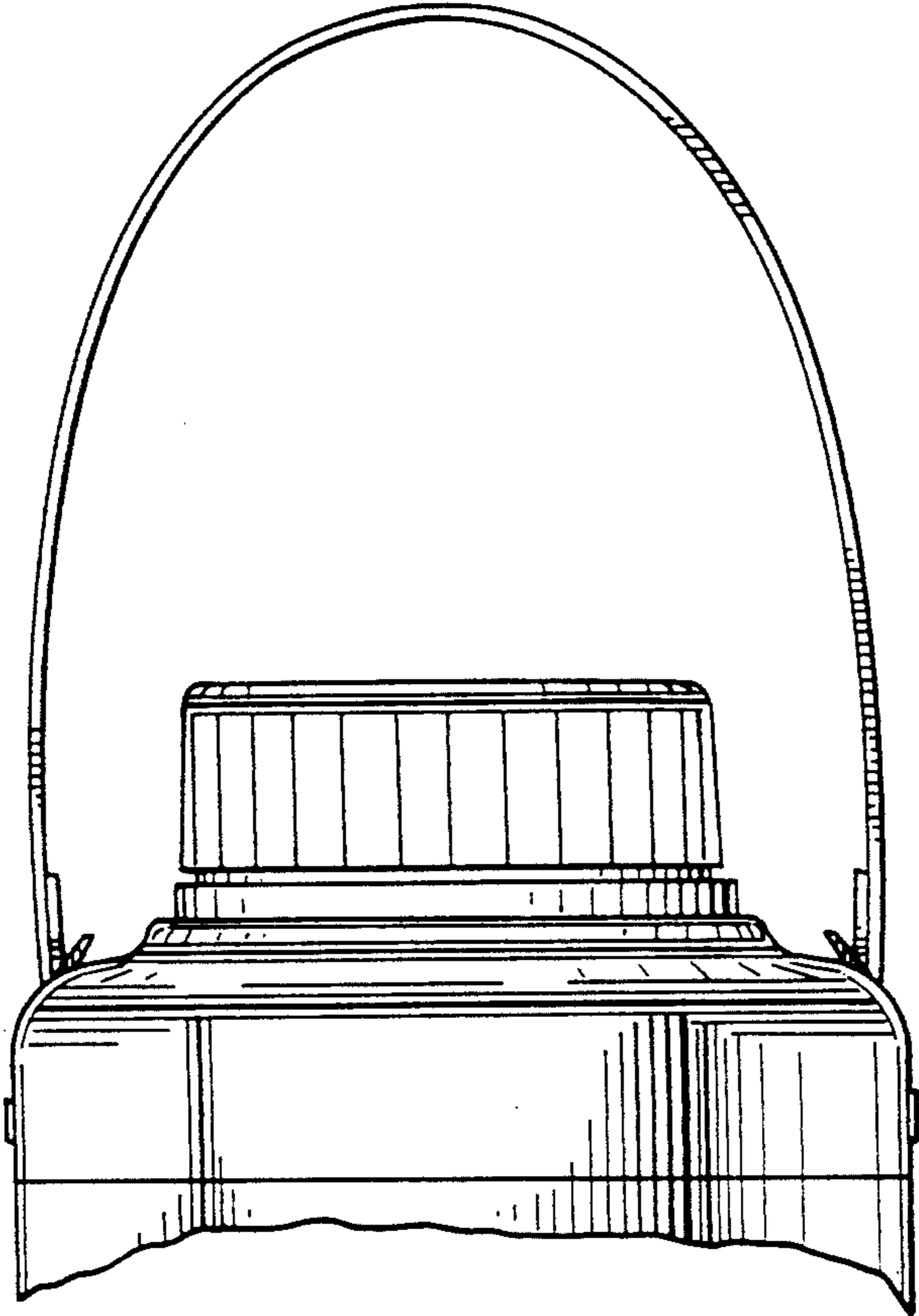
*Fig. 5*



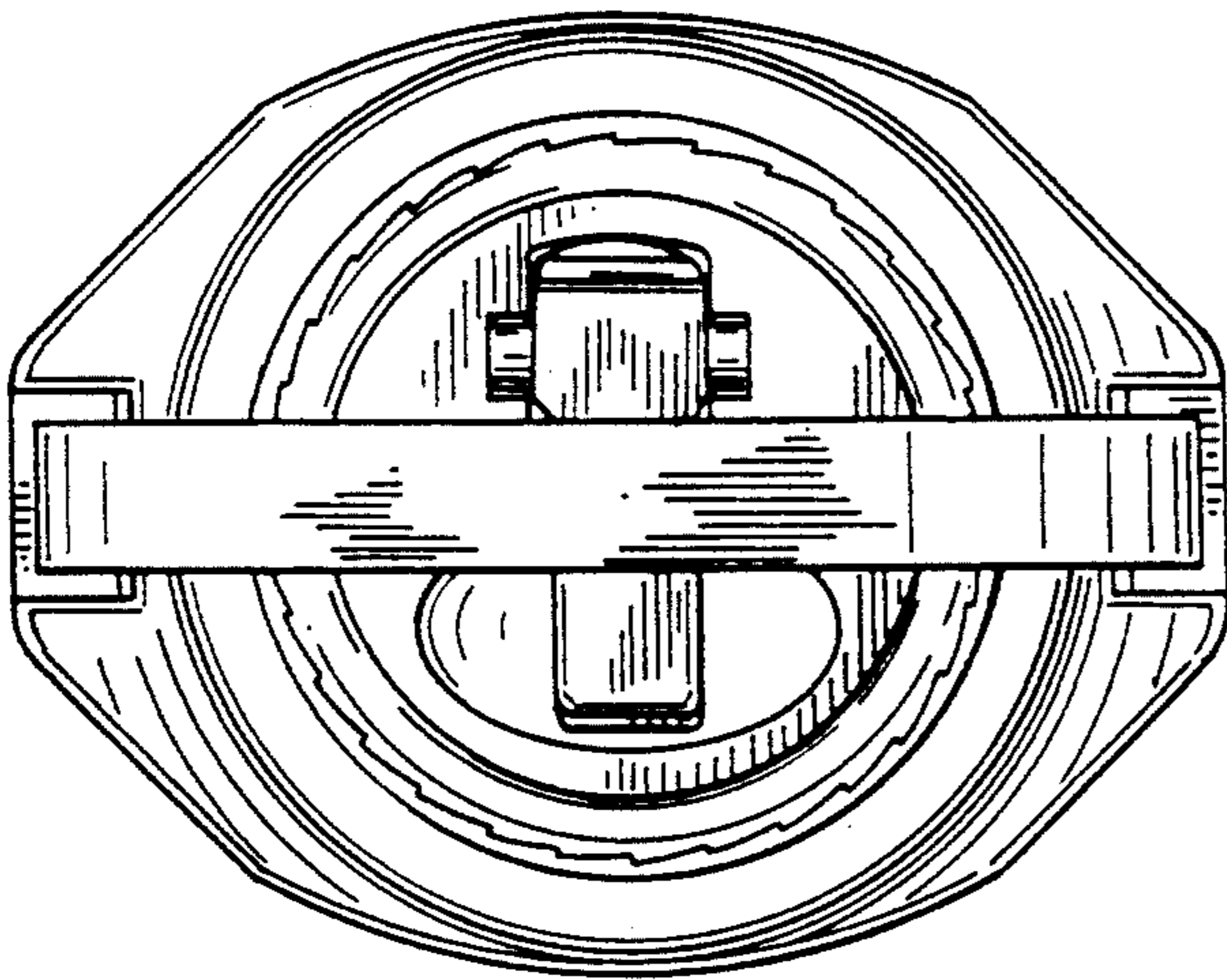
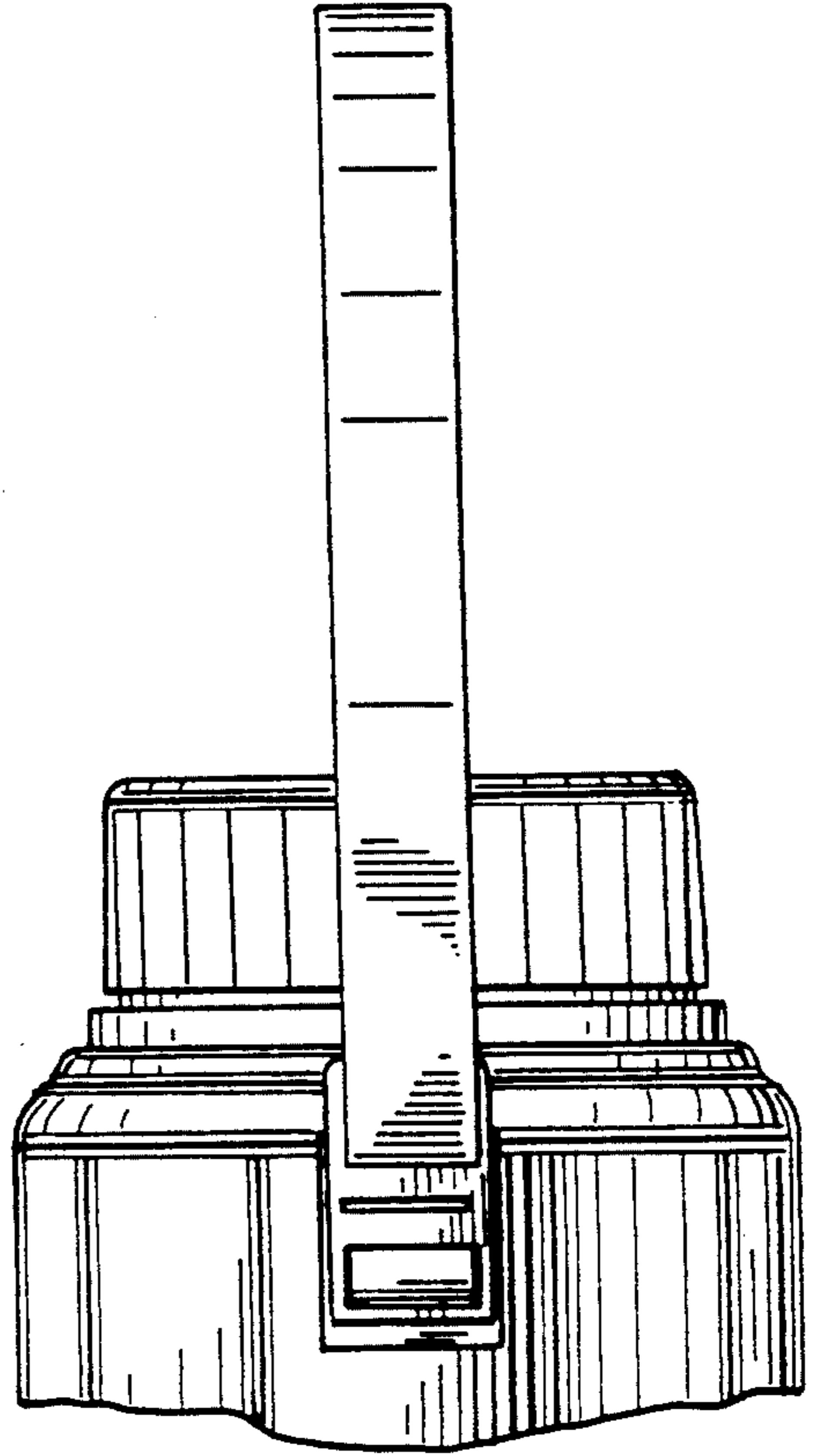
*Fig. 9*



*Fig. 10*

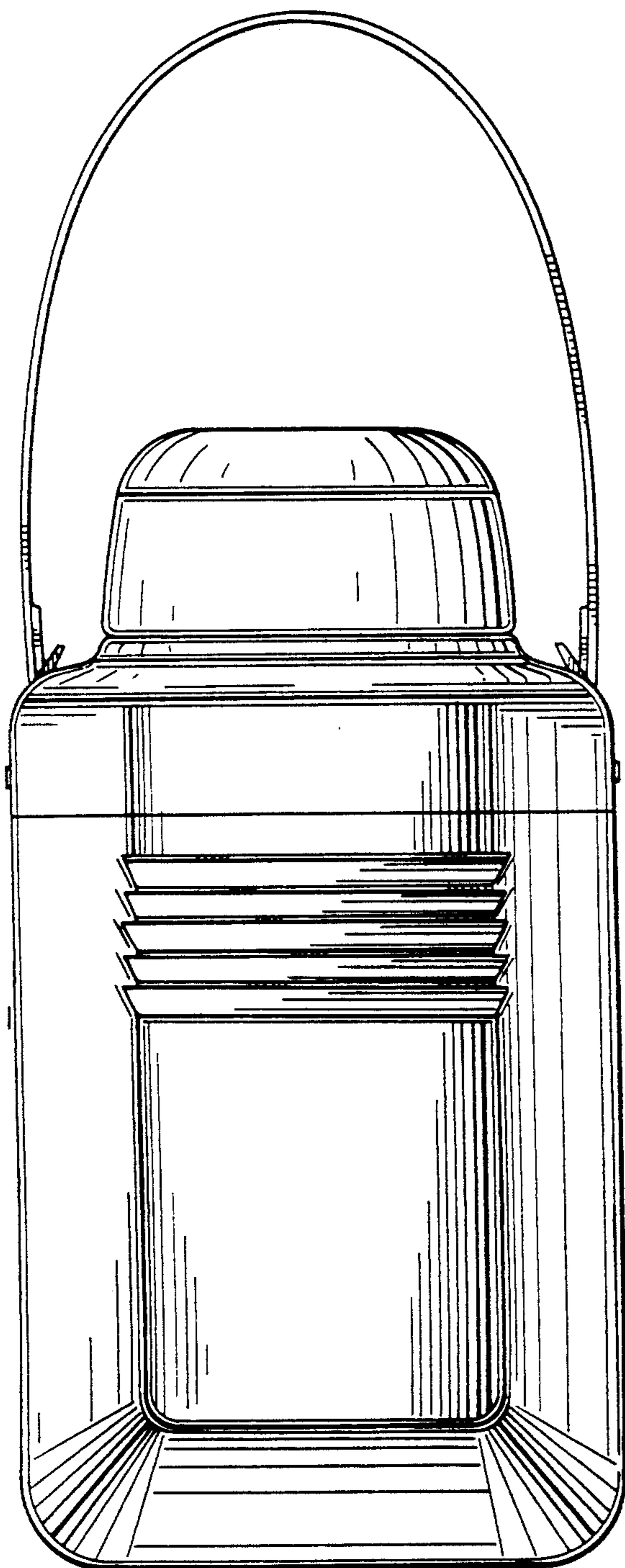


*Fig. 11*



*Fig. 12*

*Fig. 13*



*Fig. 14*

