



US00D346265S

United States Patent [19]
Smith

[11] **Patent Number: Des. 346,265**
[45] **Date of Patent: ** Apr. 19, 1994**

[54] **COMBINED BASKET AND MAILBOX**

[76] **Inventor: Louis D. Smith, 6902 SE Eola Hills Rd., Amity, Oreg. 97101**

[**] **Term: 14 Years**

[21] **Appl. No.: 564,960**

[22] **Filed: Aug. 9, 1990**

[52] **U.S. Cl. D99/29**

[58] **Field of Search 232/7, 14, 34; D99/29, D99/31, 32**

[56] **References Cited**

U.S. PATENT DOCUMENTS

- D. 112,378 11/1938 Pryne D99/33
- D. 316,321 4/1991 Lutz et al. D99/33
- 908,543 1/1909 Brown D99/29 X

Primary Examiner—Alan P. Douglas
Assistant Examiner—J. H. Musgrove
Attorney, Agent, or Firm—S. Michael Bender

[57] **CLAIM**

The ornamental design for a combined basket and mailbox, as shown and described.

DESCRIPTION

FIG. 1 is a front elevational view of the combined basket and mailbox showing my new design; FIG. 2 is a rear elevational view thereof; FIG. 3 is a left side elevational view thereof; FIG. 4 is a right side elevational view thereof; FIG. 5 is a top plan view thereof; FIG. 6 is a bottom plan view thereof; and, FIG. 7 is a front, top and right side perspective view showing the basket slid out.

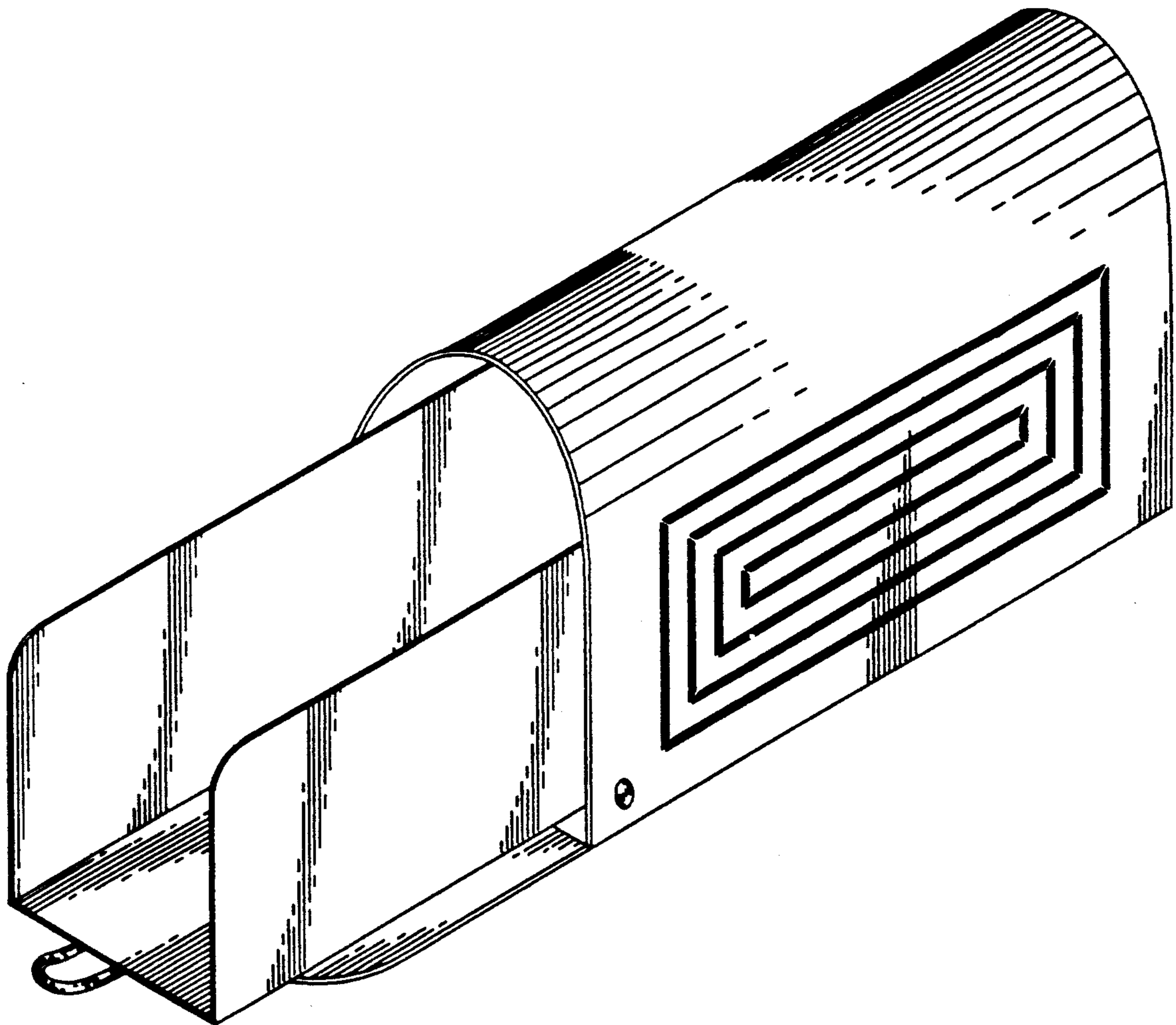

FIG. 1

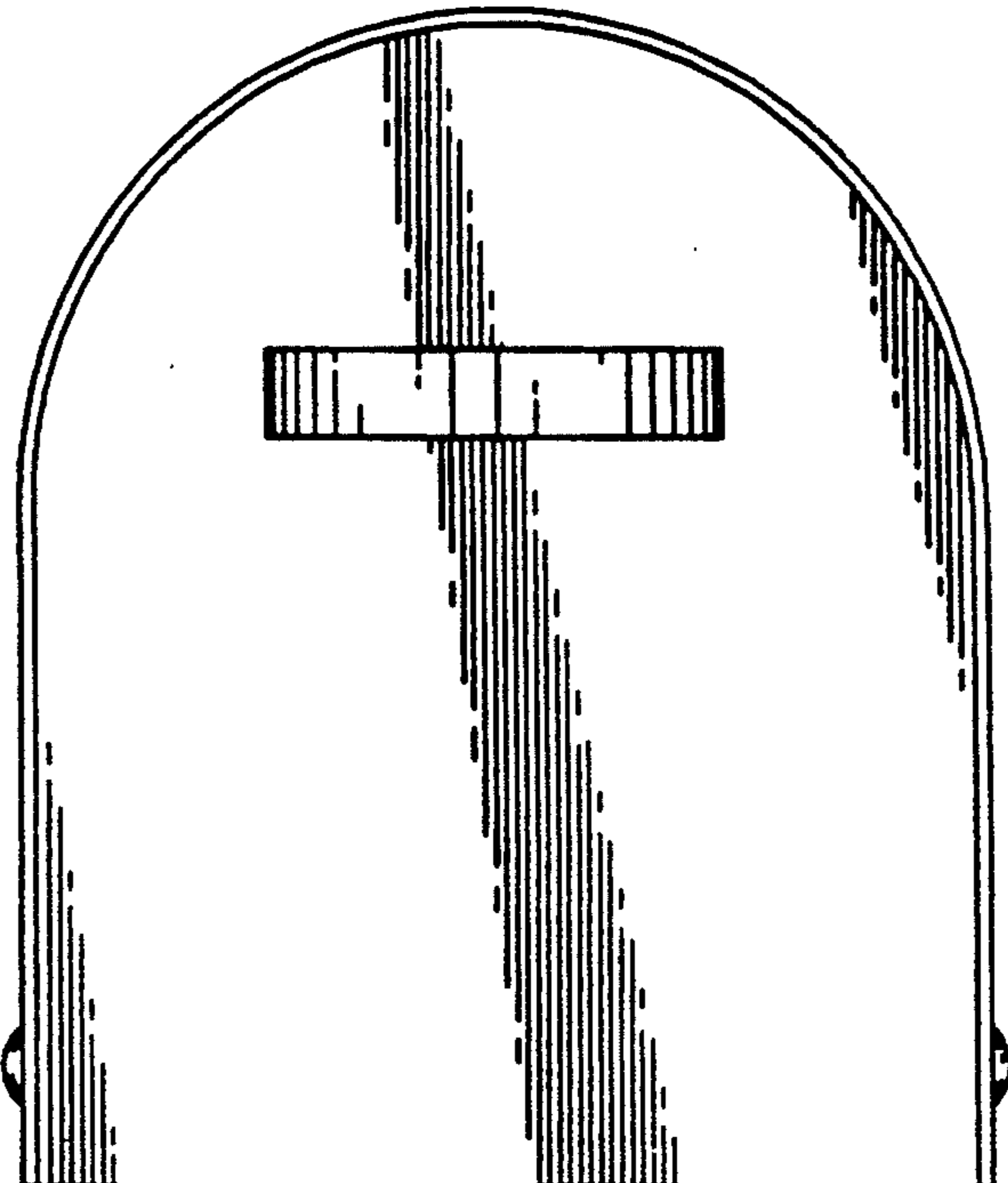

FIG. 2

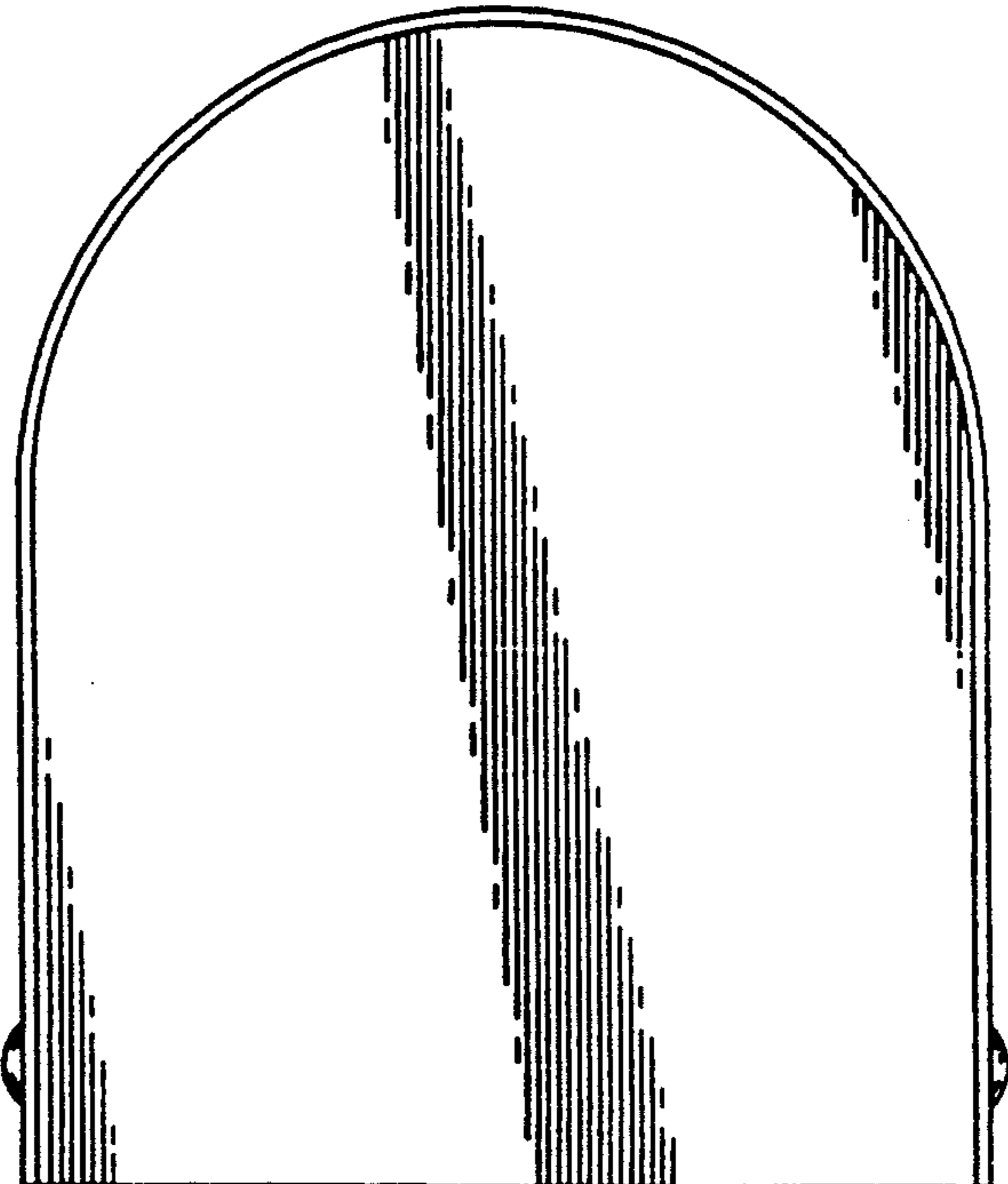

FIG. 3

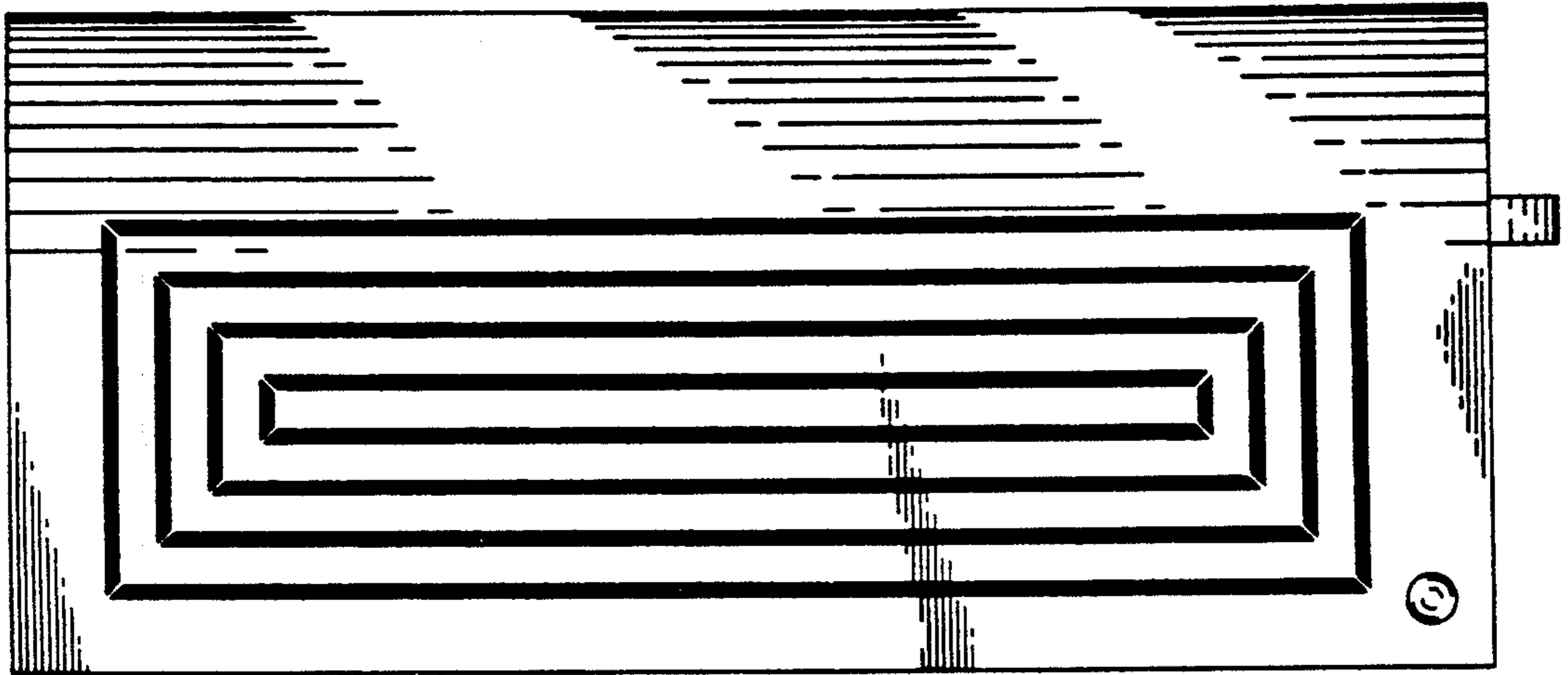

FIG. 4

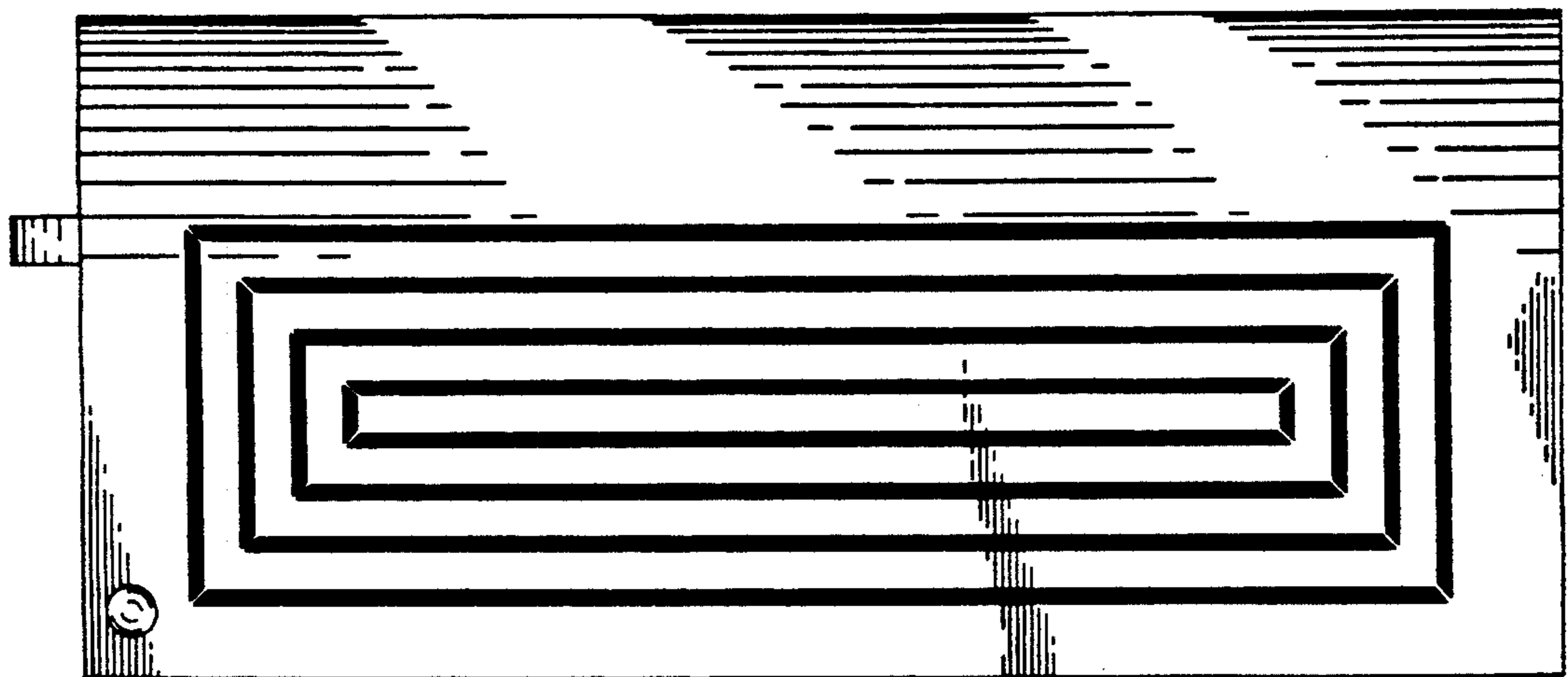

FIG. 5

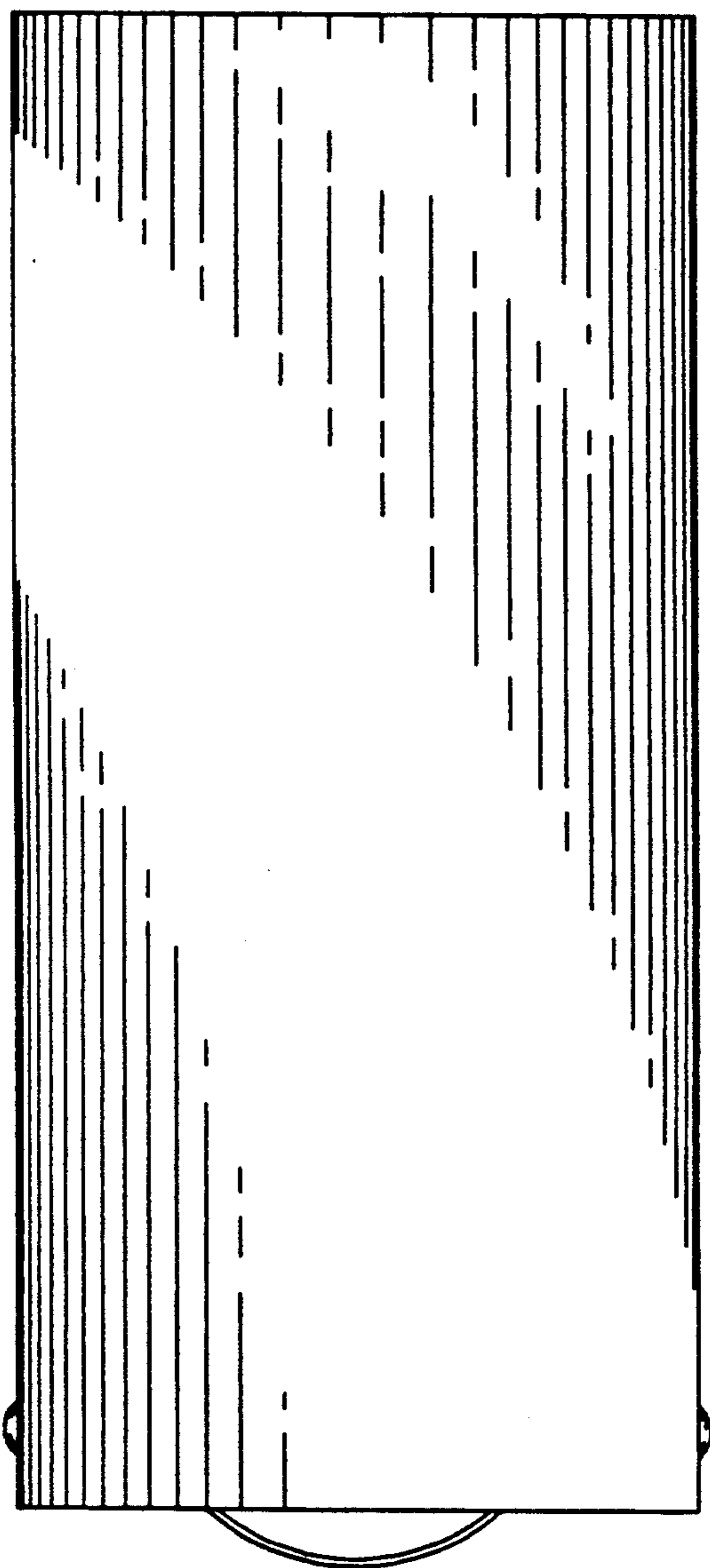

FIG. 6

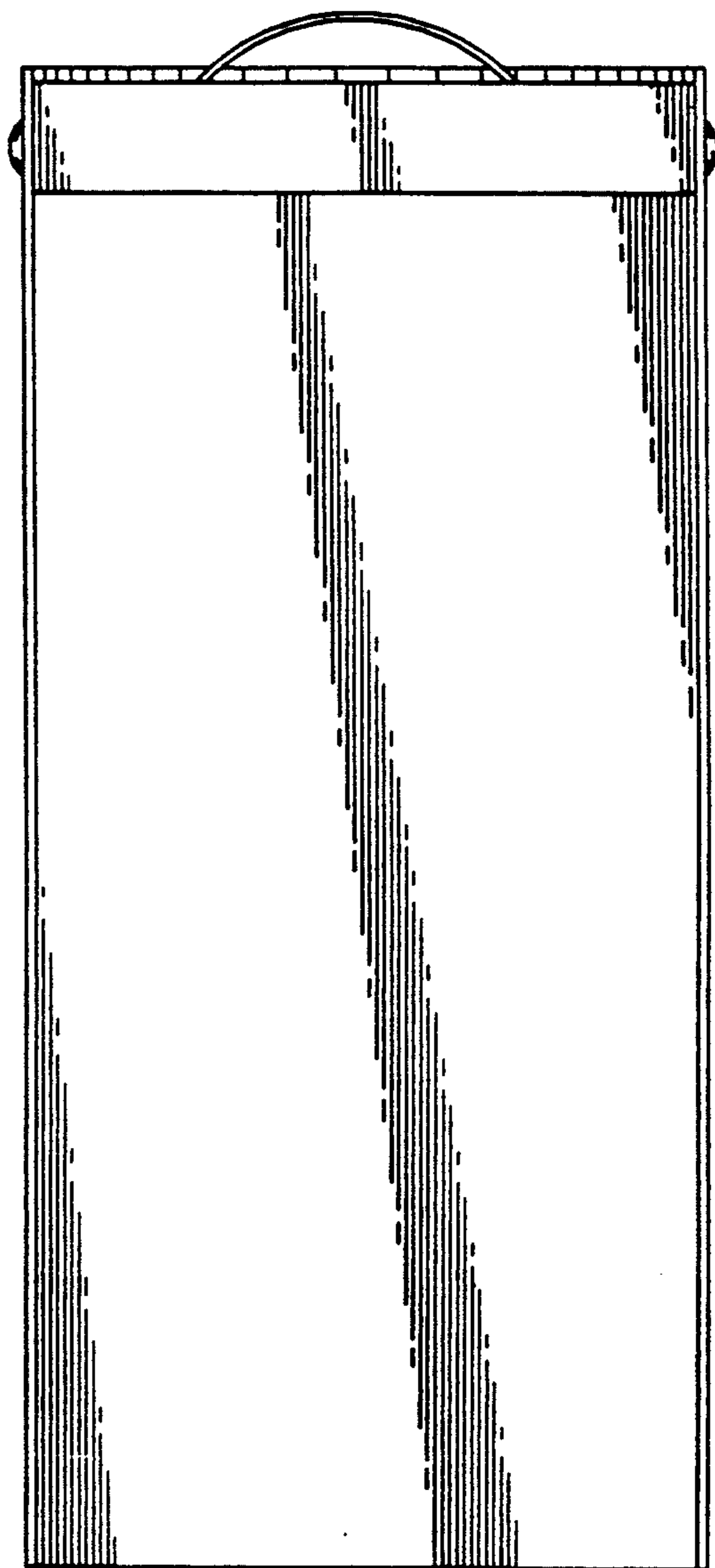

FIG. 7

