



US00D346241S

United States Patent [19] Crawford

[11] Patent Number: **Des. 346,241**
[45] Date of Patent: **** Apr. 19, 1994**

[54] **SOAP BAR**

[75] Inventor: **John C. Crawford, Lake Mahopac, N.Y.**

[73] Assignee: **Colgate-Palmolive Company, New York, N.Y.**

[**] Term: **14 Years**

[21] Appl. No.: **758,946**

[22] Filed: **Sep. 12, 1991**

[52] U.S. Cl. **D28/8.1**

[58] Field of Search **252/90-93, 252/174, 134, DIG. 16; D28/8.1, 8.2; D24/100-104**

[56] **References Cited**

U.S. PATENT DOCUMENTS

D. 16,588	3/1886	Smith	D28/8.1
D. 131,541	3/1942	Stoner et al.	D28/8.1
D. 134,045	10/1943	Voorhis	D28/8.1
D. 137,202	2/1944	Scott	D28/8.1
D. 163,038	4/1951	Haskell	D28/8.1
D. 180,321	5/1957	Dome	D28/8.1
D. 183,846	11/1958	Lippert	D28/8.1
D. 187,372	5/1960	Daily	D28/8.1 X
D. 191,075	8/1961	Horne	D28/8.1
D. 201,228	5/1965	Horne	D28/8.1
D. 201,229	5/1965	Burke	D28/8.1
D. 202,750	11/1965	Bonardi	D28/8.1
D. 207,039	2/1967	Sillett	D28/8.1
D. 209,028	10/1967	Valian	D28/8.1
D. 209,881	1/1968	Vanderhyde	D28/8.1
D. 212,542	10/1968	McCarthy	D28/8.1
D. 218,368	8/1970	Johnson	D28/8.1
D. 231,406	4/1974	Biallo	D28/8.1

D. 269,914	7/1983	Otsuka	D28/8.1
D. 298,062	10/1988	Bussell	D28/8.1
1,441,315	1/1923	Walbridge	252/134 X
1,495,978	6/1924	Anderson	252/134
2,792,349	5/1957	Le Vier et al.	D28/8.1
4,311,604	1/1982	Hornig	252/DIG. 16
4,879,063	11/1989	Wood-Rethwill et al.	252/134 X
4,965,008	10/1990	Chang	252/174

FOREIGN PATENT DOCUMENTS

2411045	9/1975	Fed. Rep. of Germany	252/92
2825529	12/1979	Fed. Rep. of Germany	252/91

OTHER PUBLICATIONS

Blair Co. Cat #766 of 1969; p. 24 center row item D.

Primary Examiner—Bernard Ansher

Assistant Examiner—C. Tuttle

Attorney, Agent, or Firm—Robert C. Sullivan; Richard J. Ancel

[57] **CLAIM**

The ornamental design for a soap bar, as shown and described.

DESCRIPTION

FIG. 1 is a top plan view of a soap bar showing my new design;

FIG. 2 is a front elevational view thereof;

FIG. 3 is a rear elevational view thereof;

FIG. 4 is a bottom plan thereof;

FIG. 5 is an end elevational view from the right side of FIG. 2;

FIG. 6 is an end elevational view from the left side of FIG. 2; and,

FIG. 7 is a section taken along line 7—7 of FIG. 1.

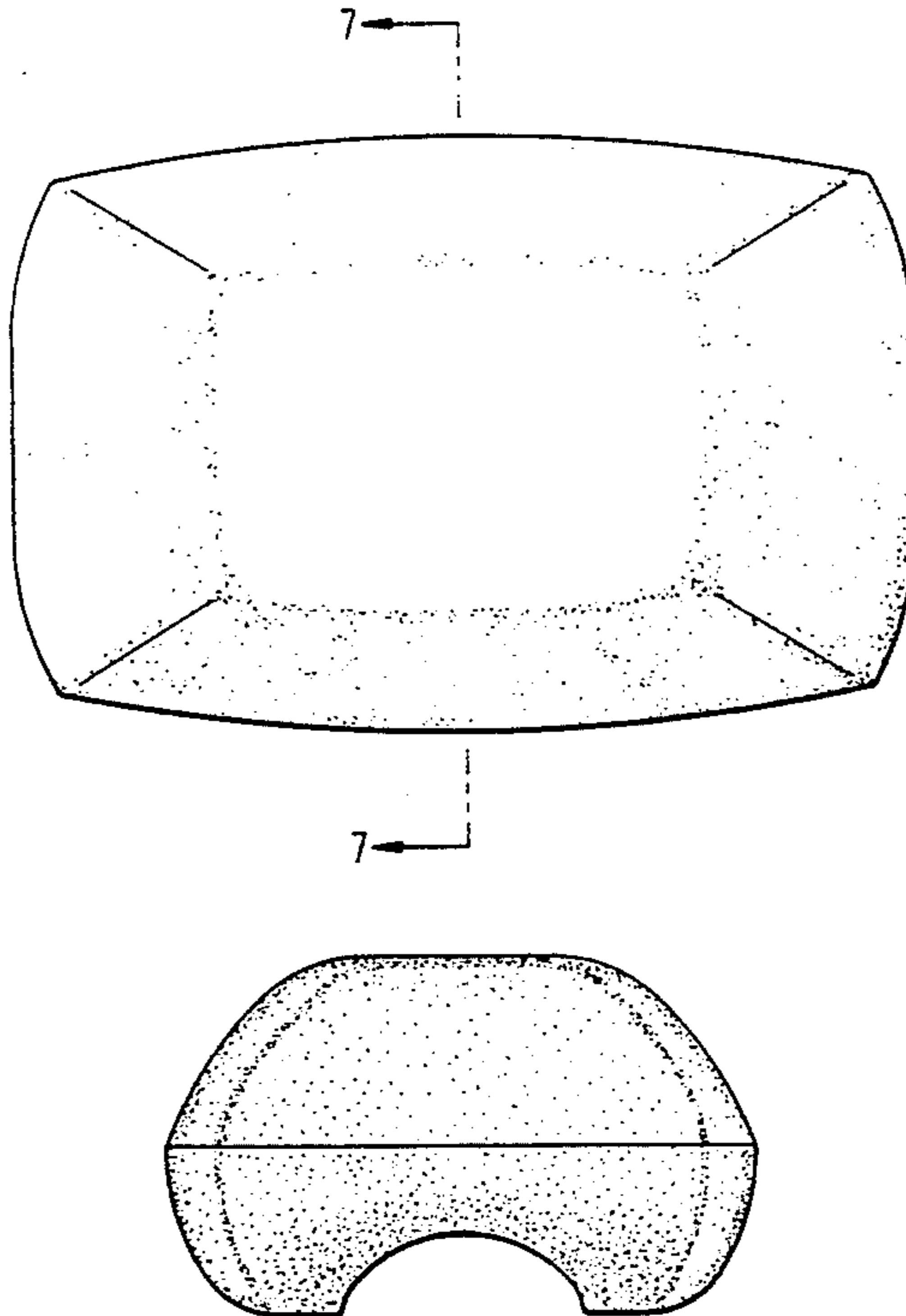

FIG. 1

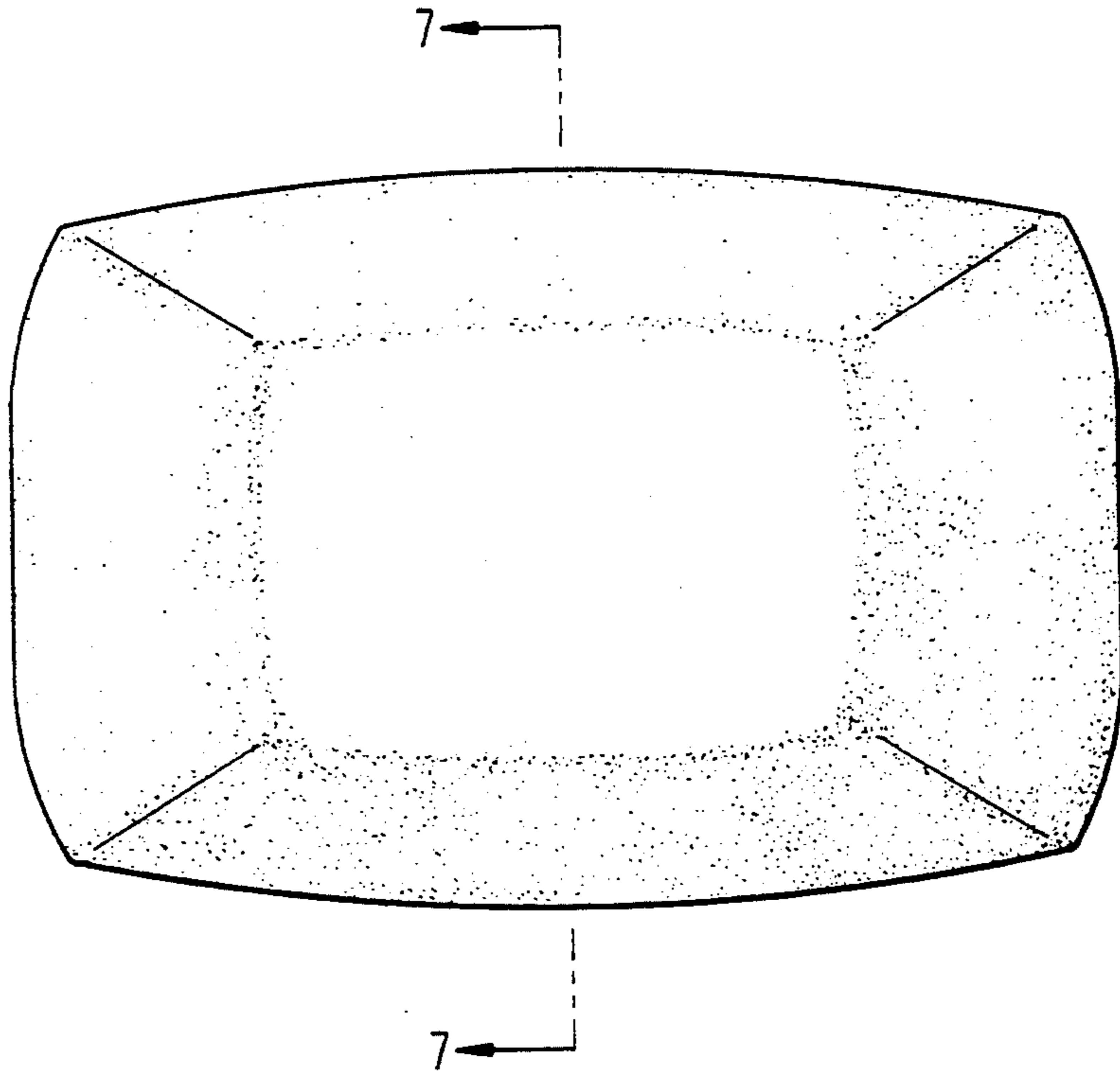

FIG. 2

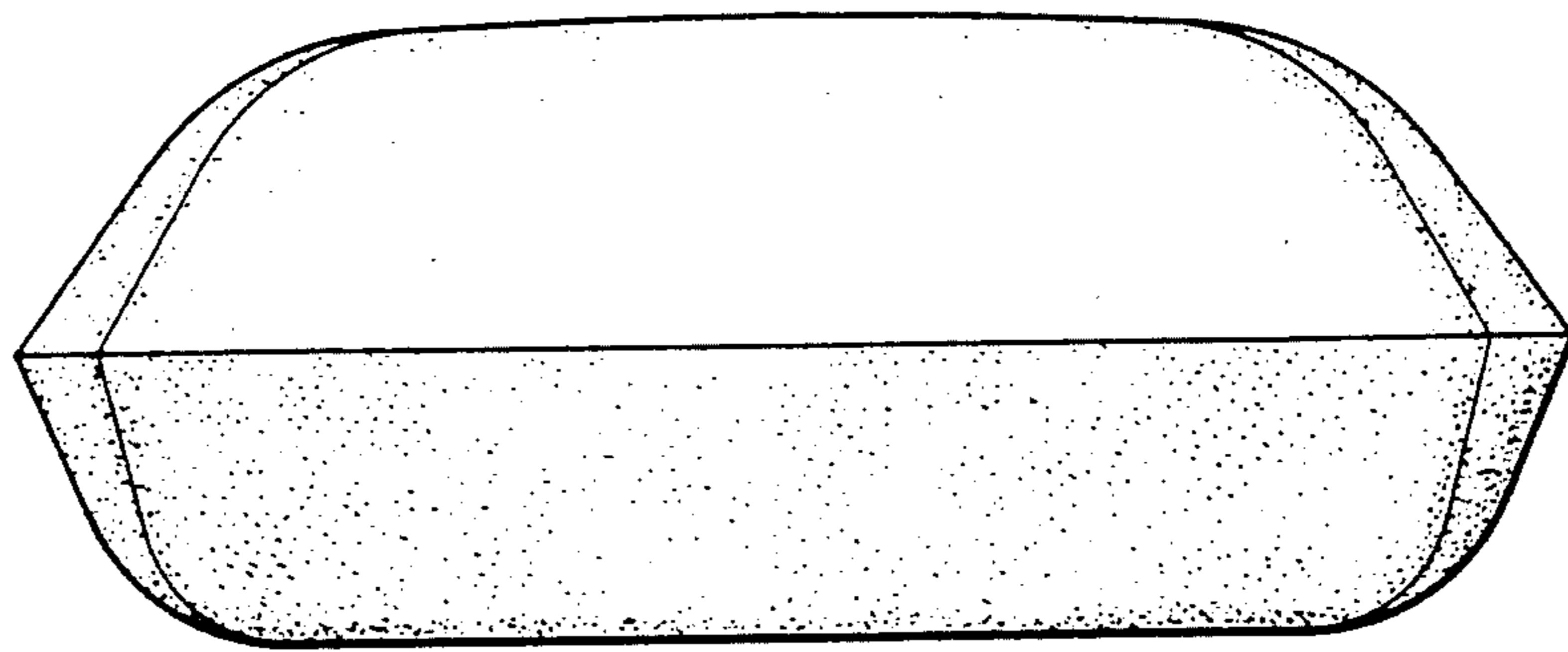

FIG. 3

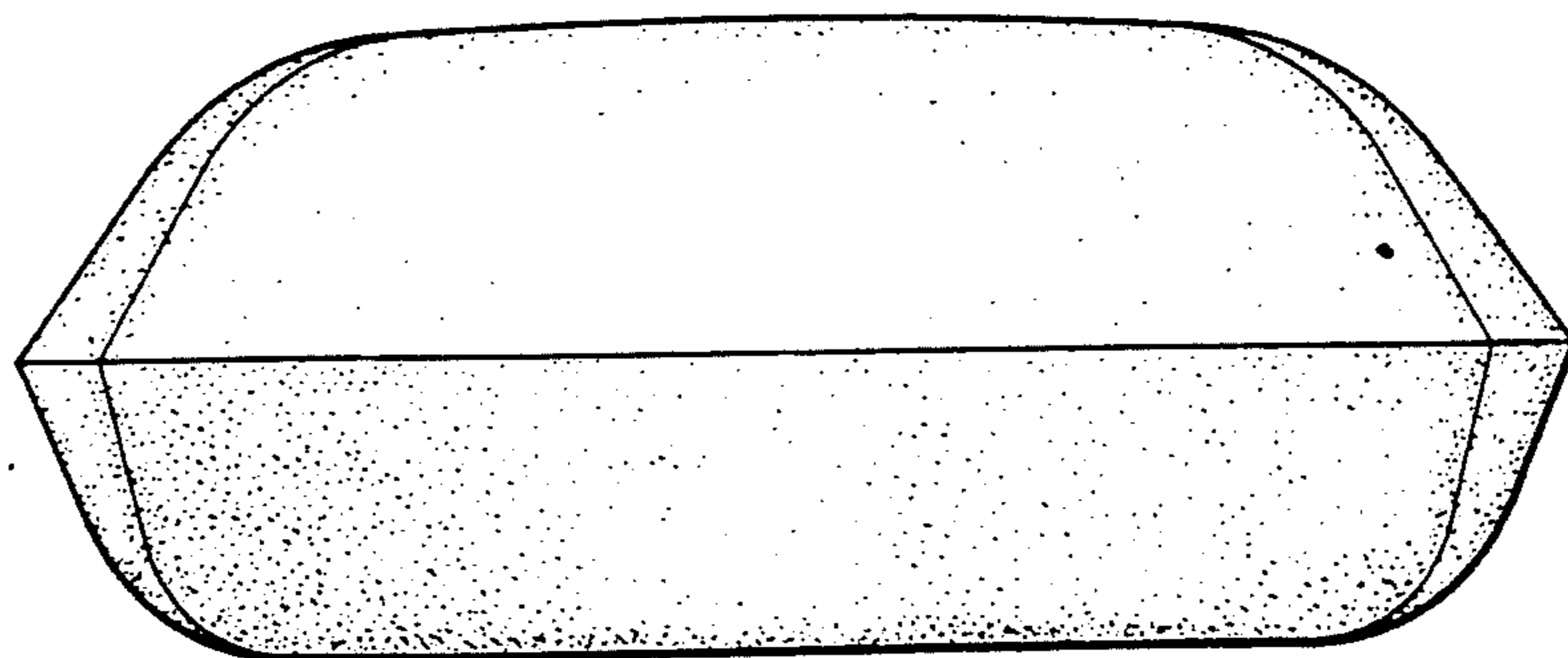

FIG. 4

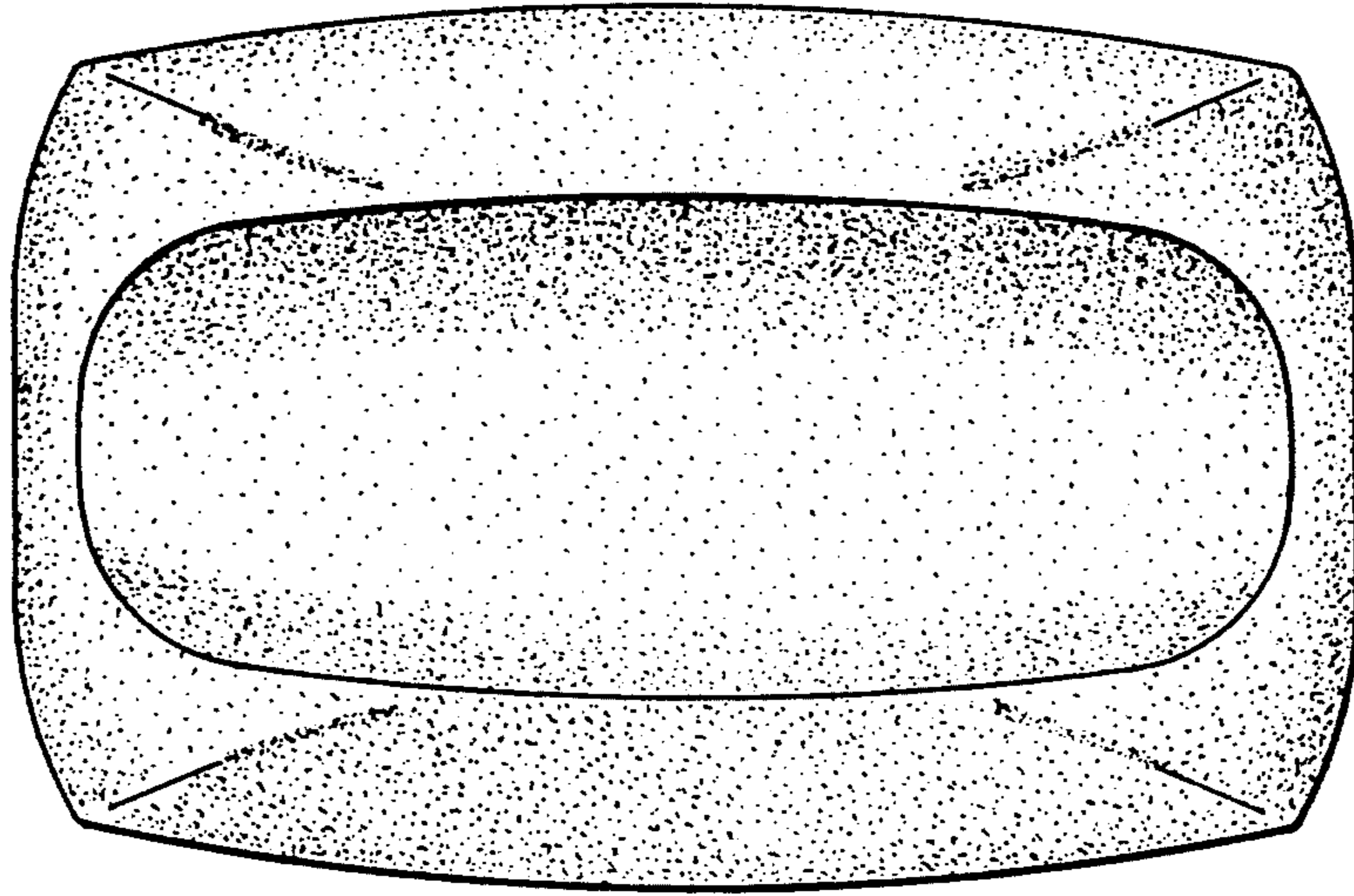

FIG. 5

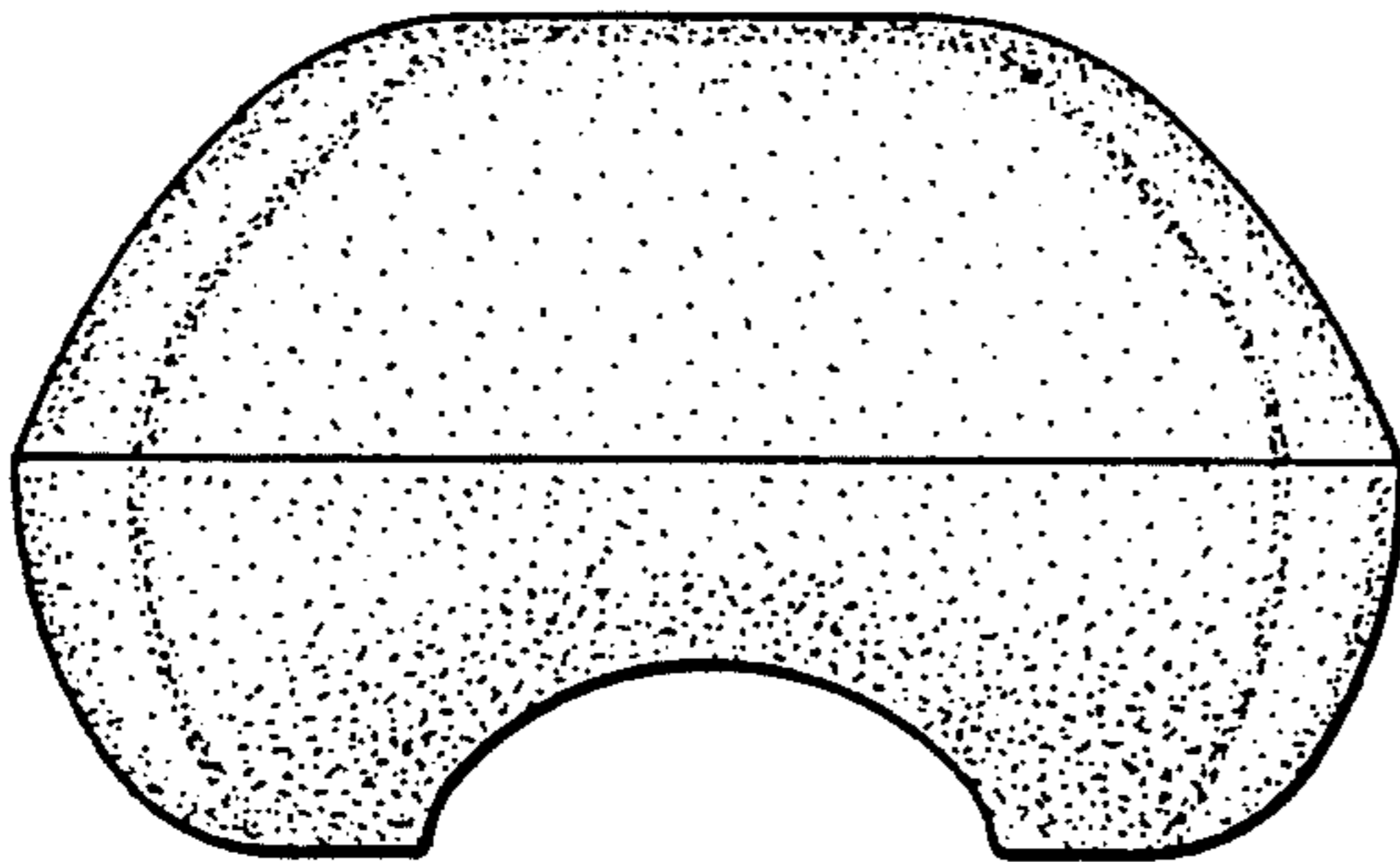

FIG. 6

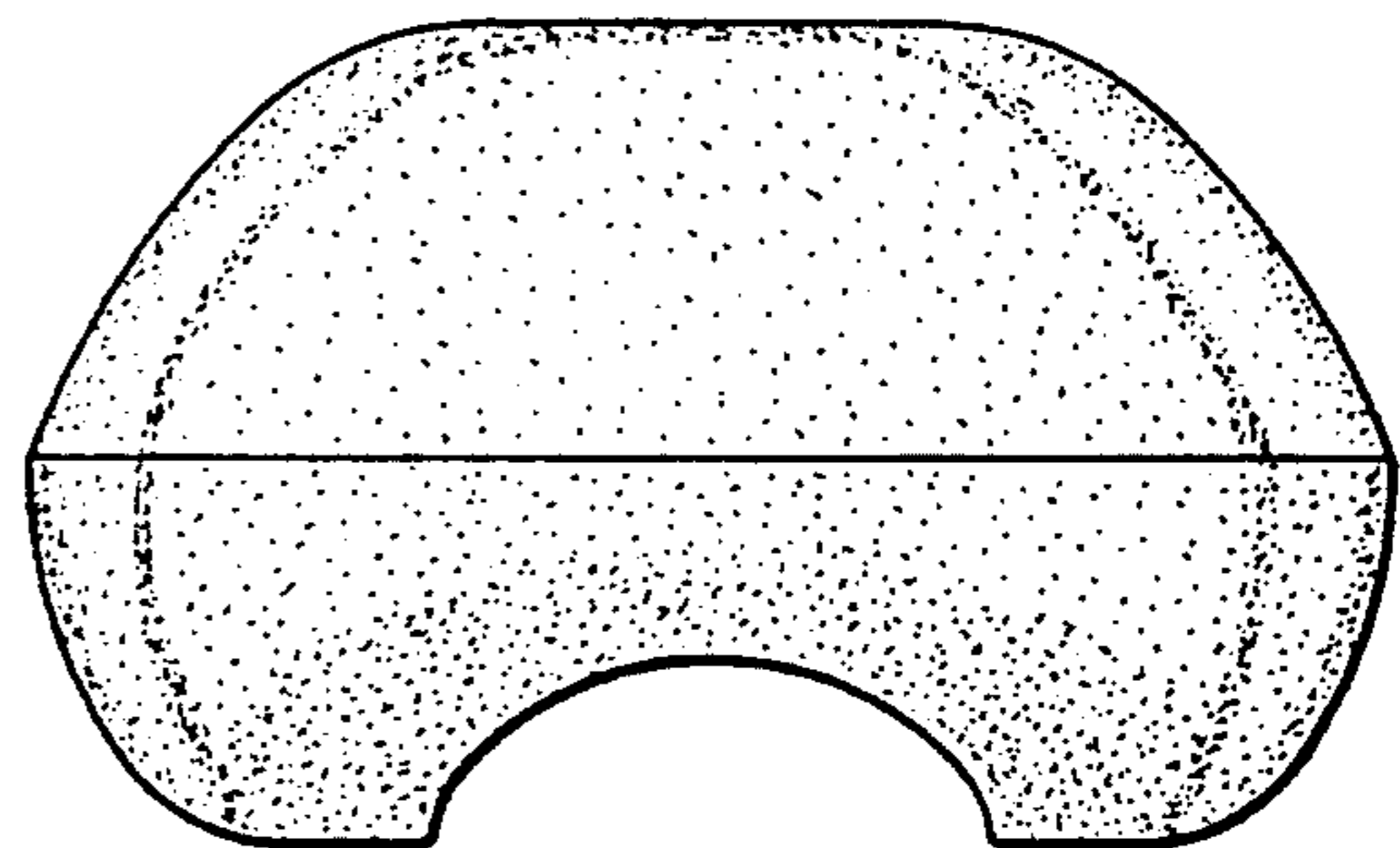

FIG. 7

