



US00D346091S

United States Patent [19]

[11] Patent Number: **Des. 346,091**

Doxey

[45] Date of Patent: **** Apr. 19, 1994**

[54] **HANDLE FOR A KITCHEN UTENSIL**

[75] Inventor: **Andre Doxey, Shaker Heights, Ohio**

[73] Assignee: **Rubbermaid Incorporated, Wooster, Ohio**

[**] Term: **14 Years**

[21] Appl. No.: **818,966**

[22] Filed: **Jan. 10, 1992**

[52] U.S. Cl. **D7/401.2**

[58] Field of Search **D7/653, 650, 688, 642, D7/664, 401.2, 691, 395; D8/107; 30/324-328**

[56] **References Cited**

U.S. PATENT DOCUMENTS

| | | | |
|------------|---------|------------------------|----------|
| D. 50,474 | 3/1917 | Jacoby | D7/653 |
| D. 54,303 | 12/1919 | Berger | D7/691 X |
| D. 75,187 | 5/1928 | Possinger | D7/691 |
| D. 77,900 | 3/1929 | Lawson | D7/691 X |
| D. 120,610 | 5/1940 | Berge | D7/691 |
| D. 203,616 | 2/1966 | Hvale | D7/691 |
| D. 255,638 | 7/1980 | Kelly | D7/691 |
| D. 273,076 | 3/1984 | Bodfish | D7/395 |
| D. 284,634 | 7/1986 | Sumikama | D7/395 |
| D. 293,295 | 12/1987 | Johnson | D7/688 |
| D. 301,533 | 6/1989 | Zimmerman | D7/653 X |
| D. 303,603 | 9/1989 | Zimmerman | D7/650 |
| D. 306,116 | 2/1990 | Zimmerman | D7/653 |
| D. 307,095 | 4/1990 | Juergens | D7/653 |
| D. 311,307 | 10/1990 | Cautereels et al. | D7/683 |
| 433,546 | 8/1890 | Smith | D7/692 X |
| 2,593,949 | 4/1952 | Williams | D7/692 X |
| 3,804,450 | 4/1980 | Guenzel | 294/51 |

OTHER PUBLICATIONS

Pp. 4, 5, 7, 8, 9, 11 and 12, Utensils, Aluminum Housewares Co., Inc., Fairgrove Products, P.O. Box 1599, Maryland Heights, Mo. 63043-0599. Publication date Jan. 1, 1991.

Pp. 5, 6, 7 and 9, Utensils, Housewares of all Nations, Hoan Products, Ltd., 820 Third Avenue, Brooklyn, N.Y. 11232. Publication date 1988.

Catalog Page, Utensils, Bonny Products, Inc., 10 Peninsula Boulevard, Lynbrook, N.Y. 11563. Publication date 1984.

P. F, Utensils, Bonny Products, Inc., 10 Peninsula Boulevard, Lynbrook, N.Y. 11563. Publication date 1984.

Label and Photo, Utensil, Ekco Housewares Company, 9234 W. Belmont Avenue, Franklin Park, Ill. 60131. Publication date 1983.

Pp. 2-1, 2-2, 2-4, 2-6, 2-8, 2-10, 2-11 and 2-12, Utensils, Ekco Housewares Company, 9234 West Belmont Avenue, Franklin Park, Ill. 60131. Publication date Sep. 1, 1985.

P. 14, Utensils, The Tupperware Company, 130 College Road, Harrow, Middax HA1 1BQ, United Kingdom. It is believed that the product depicted herein has been on sale for more than one (1) year prior to the application date of this instant application.

Price List, Utensil, Bradshaw International, Inc., 9303 Greenleaf Avenue, Sante Fe Springs, Calif. 90670. Publication date Jan. 1, 1991.

Label and Photo, Utensil, Robinson Knife Company, 41 Madison Avenue, New York, N.Y. 10010. Publication date 1988.

Sell Sheet, Utensils, The Foley Company, P.O. Box 648, Manitowoc, Wis. 54220. Publication date Nov., 1989.

P. 13, Utensils, Rubbermaid Commercial Products Inc., 3124 Valley Avenue, Winchester, Va. 22601. Publication date 1989.

Catalog Page, Utensils, Dupol-Rubbermaid GmbH, An der Trift 63, D-6072 Dreieich, Germany. Publication date 1977.

Primary Examiner—Alan P. Douglas

Assistant Examiner—Caron D. Vegnar

Attorney, Agent, or Firm—Richard B. O'Planick; Lisa B. Riedesel

[57] **CLAIM**

The ornamental design for a handle for a kitchen utensil, as shown and described.

DESCRIPTION

FIG. 1 is a top, right, and front perspective view of a handle for a kitchen utensil showing my new design; FIG. 2 is a front elevational view thereof; FIG. 3 is a rear elevational view thereof; FIG. 4 is a top plan view thereof;

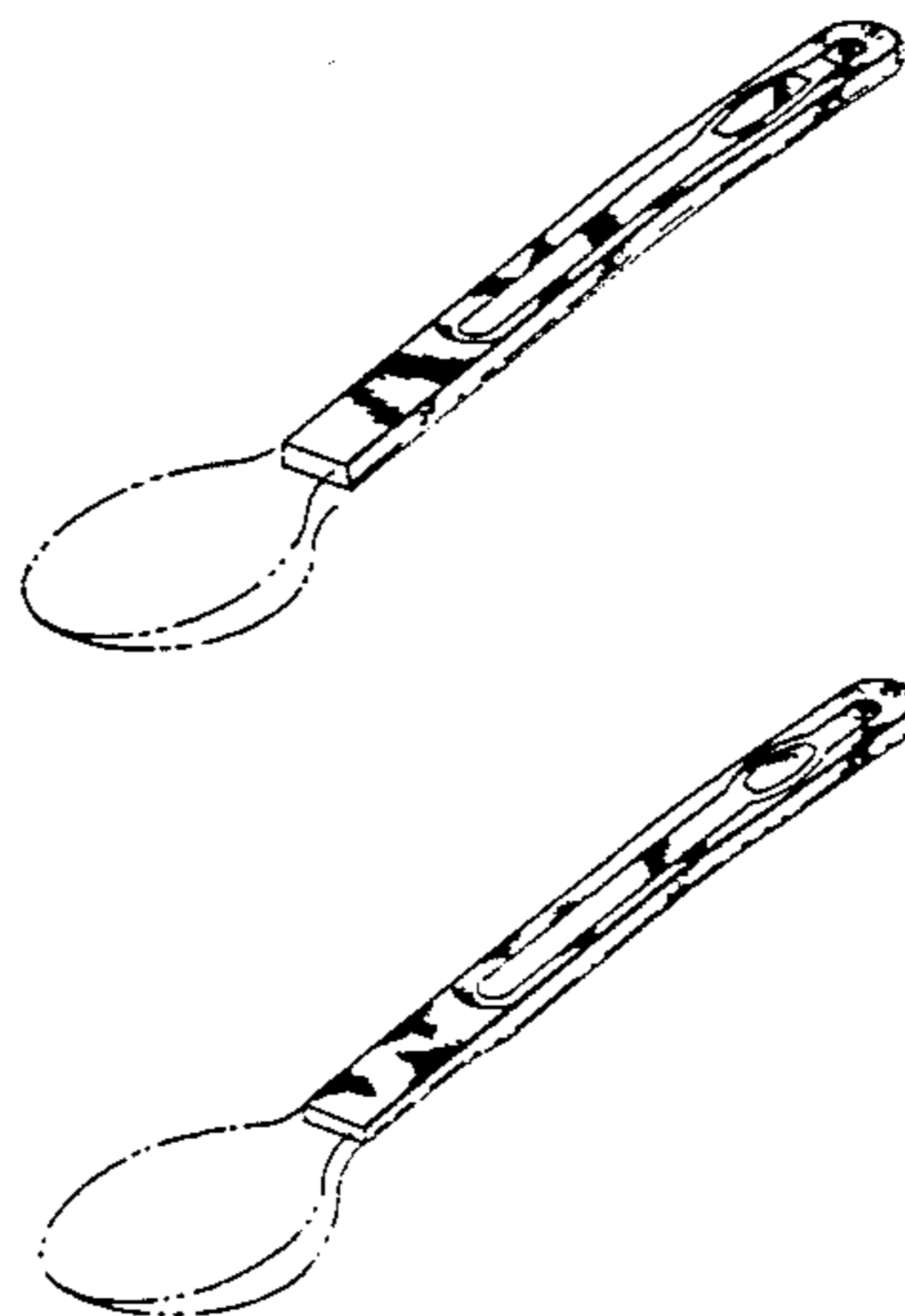

FIG. 5 is a left side elevational view thereof; the opposite side being a mirror image;
FIG. 6 is a bottom plan view thereof;
FIG. 7 is a top, right and front perspective view of a second embodiment of my new design of FIGS. 1-6;
FIG. 8 is a rear elevational view thereof;

FIG. 9 is a left side elevational view thereof; the opposite side being a mirror image; and,
FIG. 10 is a bottom plan view thereof. The top plan view would be as shown in FIG. 4.
The broken line showing of a spoon bowl in FIGS. 1 and 7 is environmental only and forms no part of the claimed design.

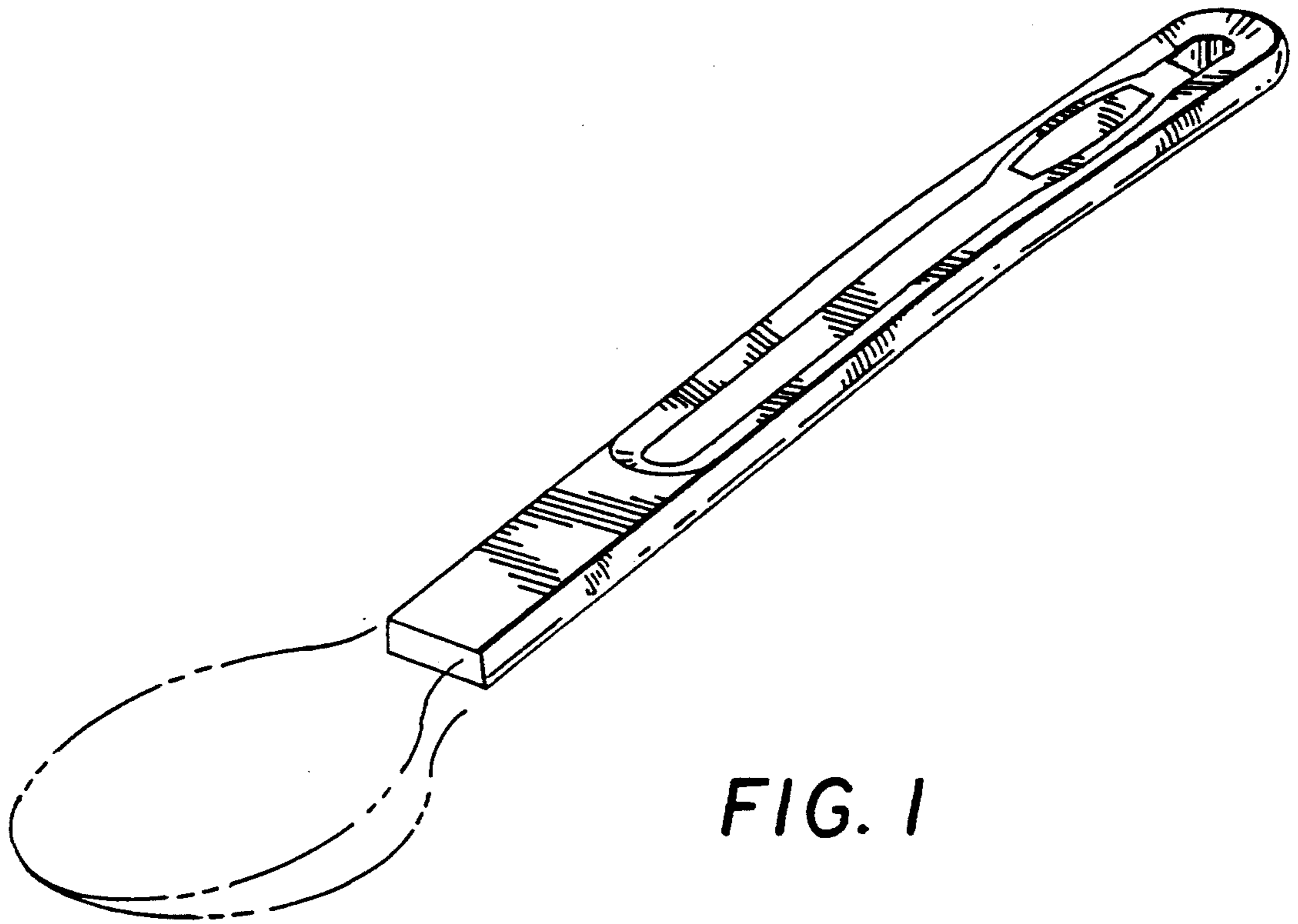

FIG. 1

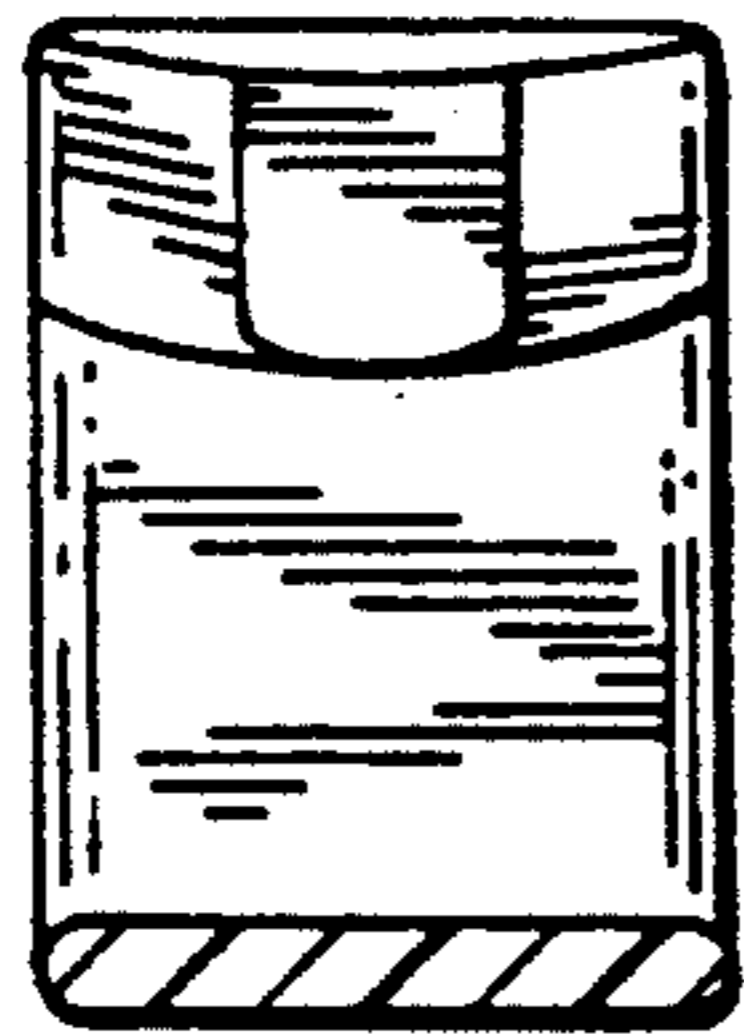

FIG. 2

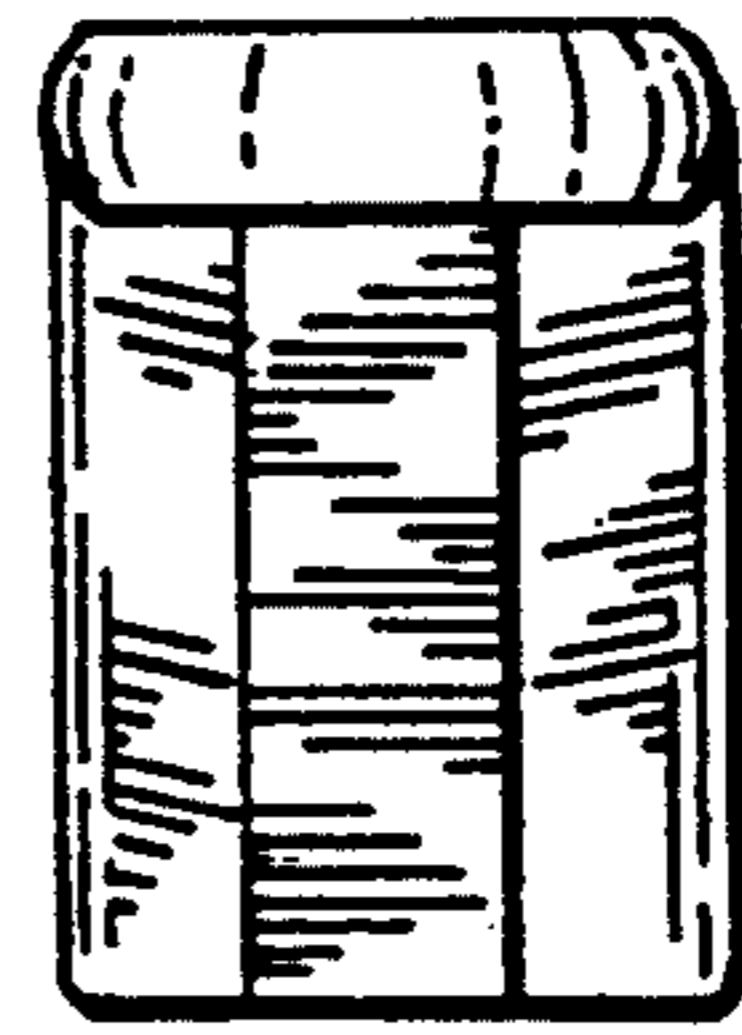

FIG. 3

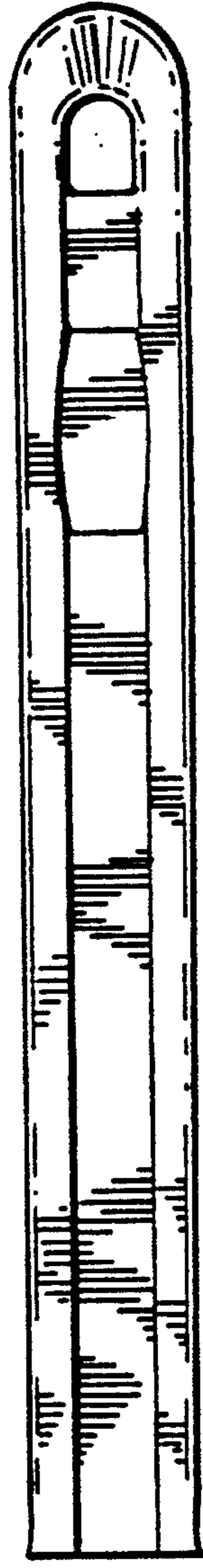
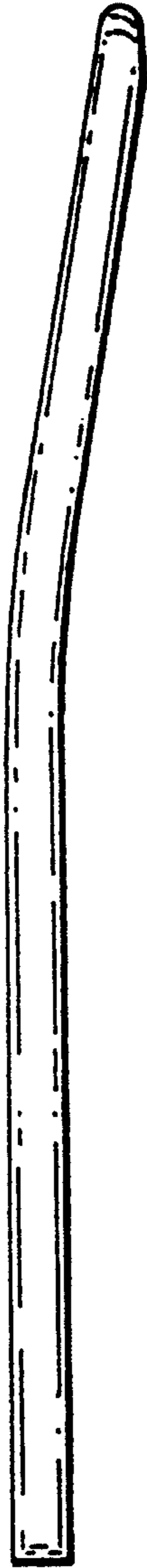
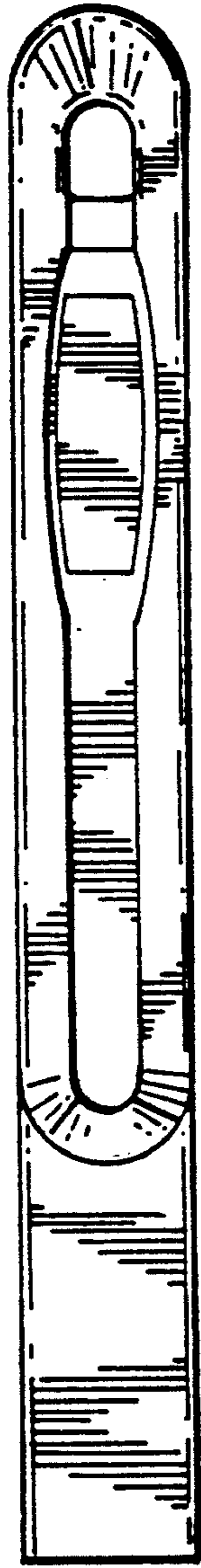

FIG. 4

FIG. 5

FIG. 6

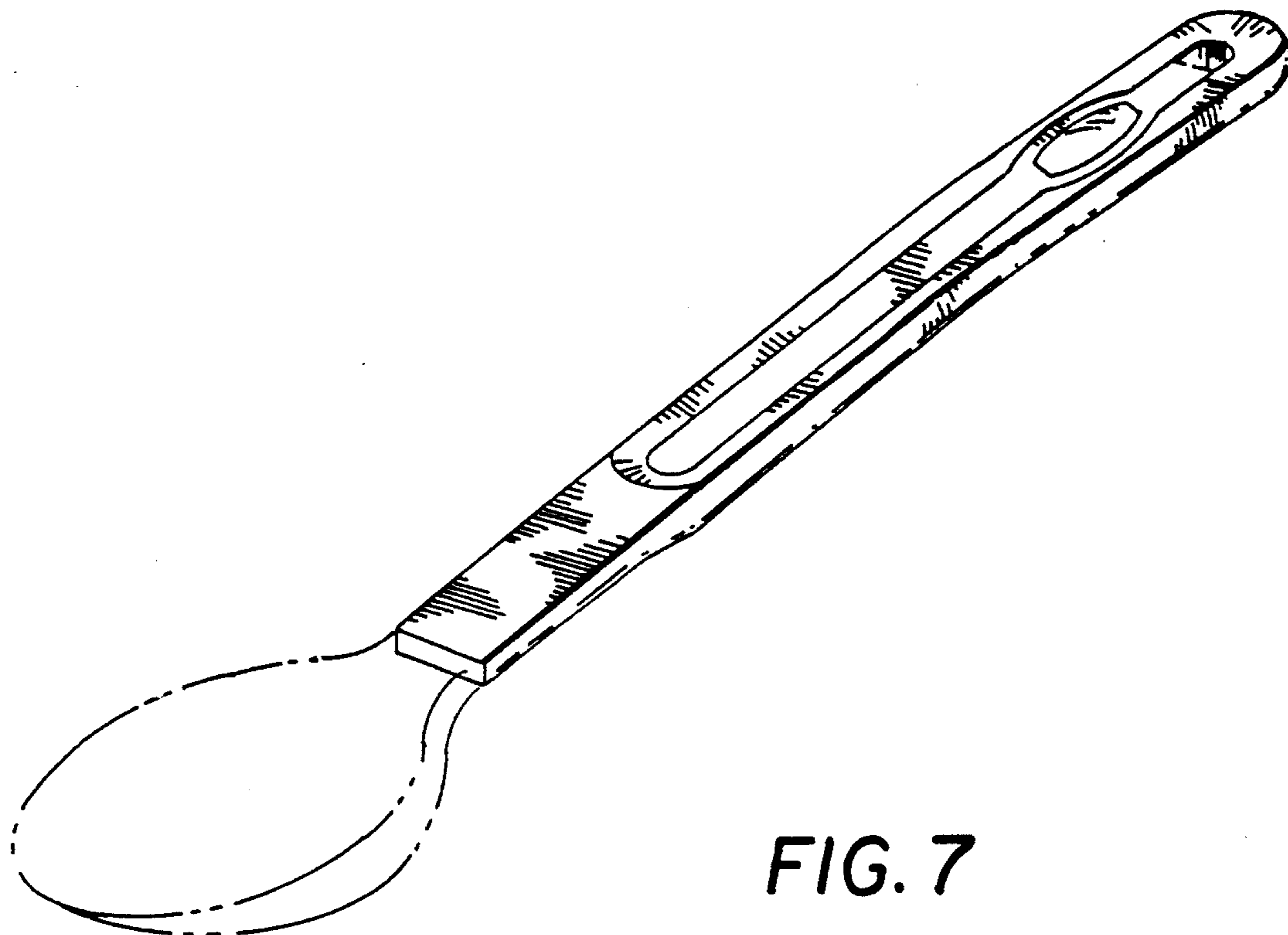

FIG. 7

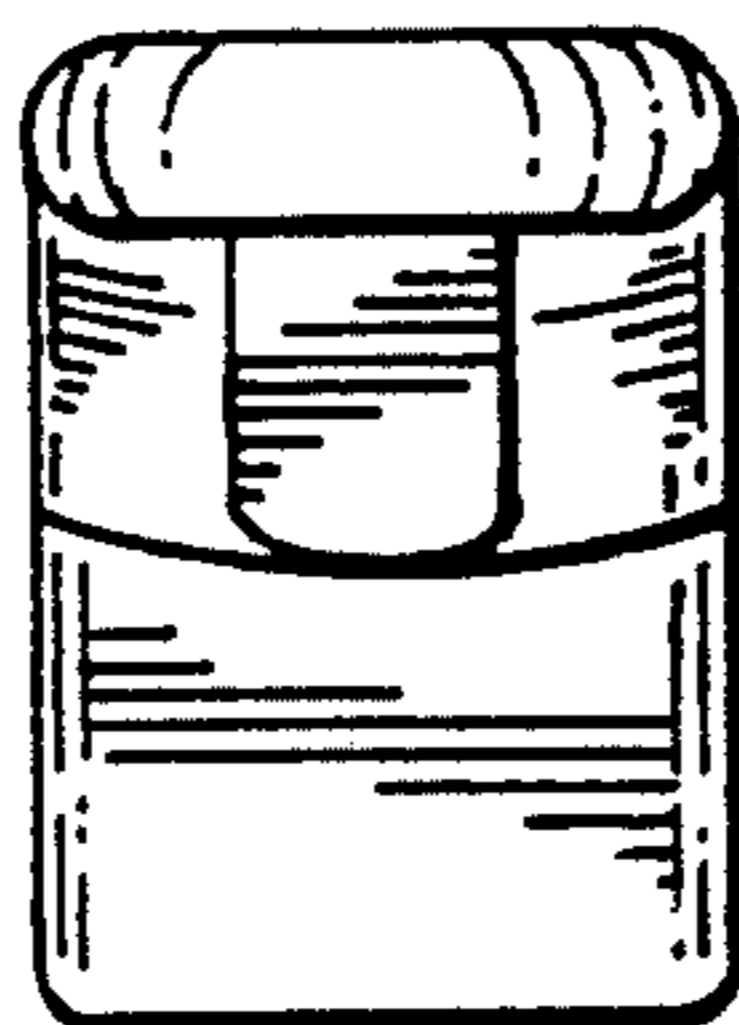

FIG. 8

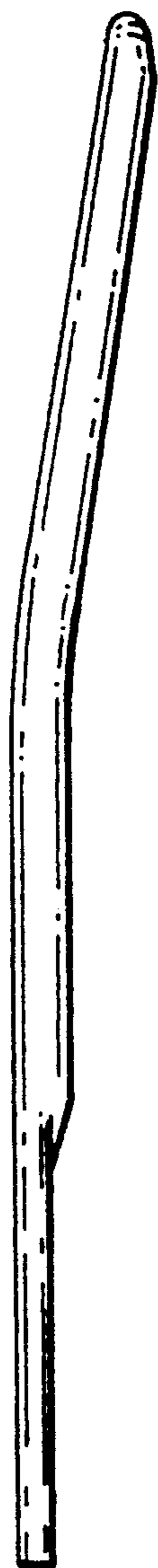

FIG. 9

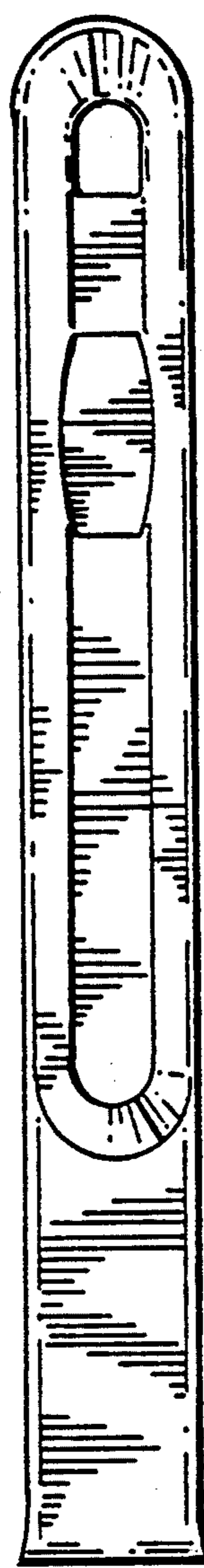

FIG. 10