



US00D346085S

# United States Patent [19]

[11] Patent Number: Des. 346,085

Wagner

[45] Date of Patent: \*\* Apr. 19, 1994

[54] HOLDER FOR REMOTE CONTROLS

[76] Inventor: John P. Wagner, 1318 Seven Oakes Rd., Escondido, Calif. 92026

[\*\*] Term: 14 Years

[21] Appl. No.: 827,816

[22] Filed: Jan. 28, 1992

[52] U.S. Cl. .... D6/513; D3/218

[58] Field of Search ..... D6/513-514, D6/567, 569; D3/40; 211/13, 86, 113; 224/42.42, 42.46 R

[56] **References Cited**

**U.S. PATENT DOCUMENTS**

- D. 324,810 3/1992 Moye, Sr. .... D3/40 X
- D. 329,836 9/1992 Meyers ..... D3/40 X
- D. 333,580 3/1993 Brummett ..... D6/513
- 2,767,895 10/1956 Smith ..... 224/42.42

Primary Examiner—Brian N. Vinson

Attorney, Agent, or Firm—Brown, Martin, Haller & McClain

[57] **CLAIM**

The ornamental design for a holder for remote controls, as shown.

**DESCRIPTION**

FIG. 1 is a top, front, and left side perspective view of a holder for remote controls showing my new design; FIG. 2 is a top, rear, and right side perspective view thereof;

FIG. 3 is a top plan view thereof, the fragmentary disclosure of a portion of an armchair being for illustrative purposes only and forming no part of the claimed design;

FIG. 4 is a top, front, and left side perspective view of an alternative embodiment of a holder for remote controls showing my new design;

FIG. 5 is a top, rear, and right side perspective view thereof; and,

FIG. 6 is a bottom plan view thereof.

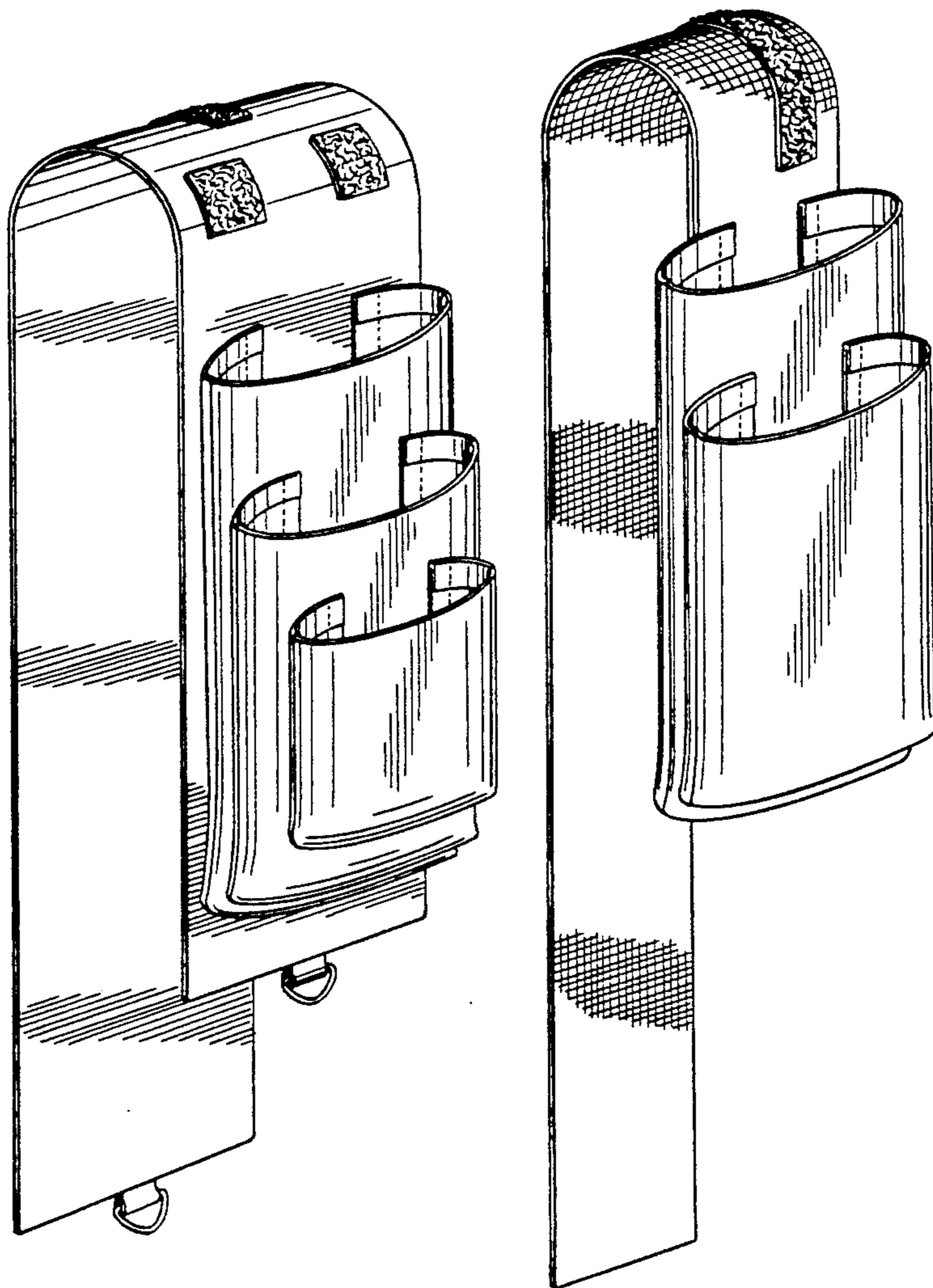

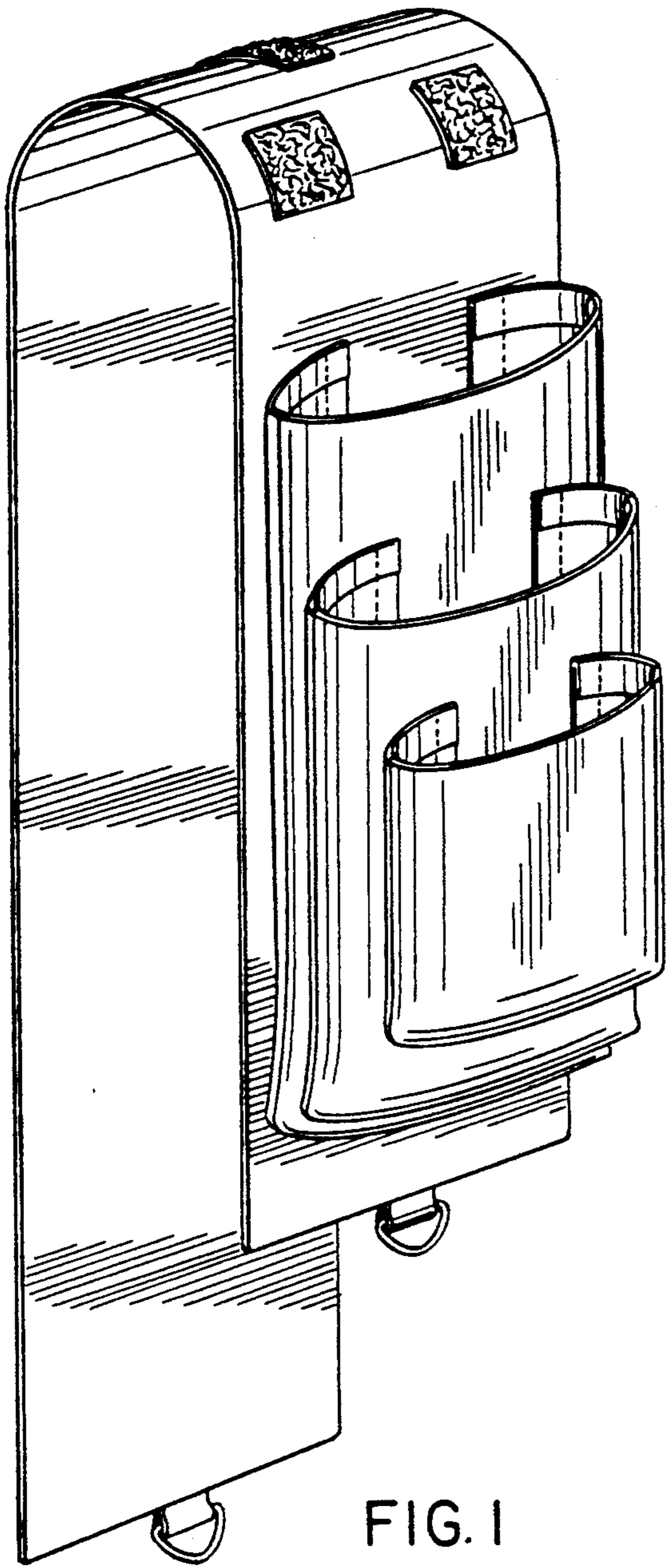

FIG. 1

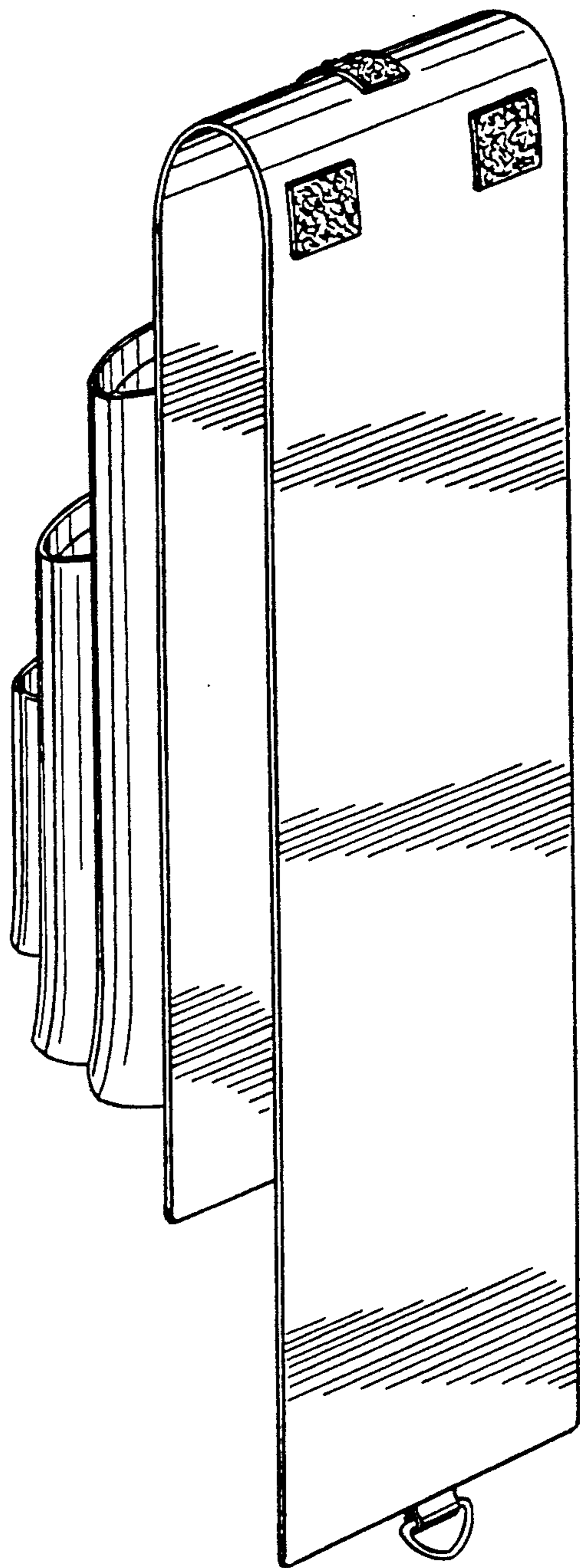

FIG. 2

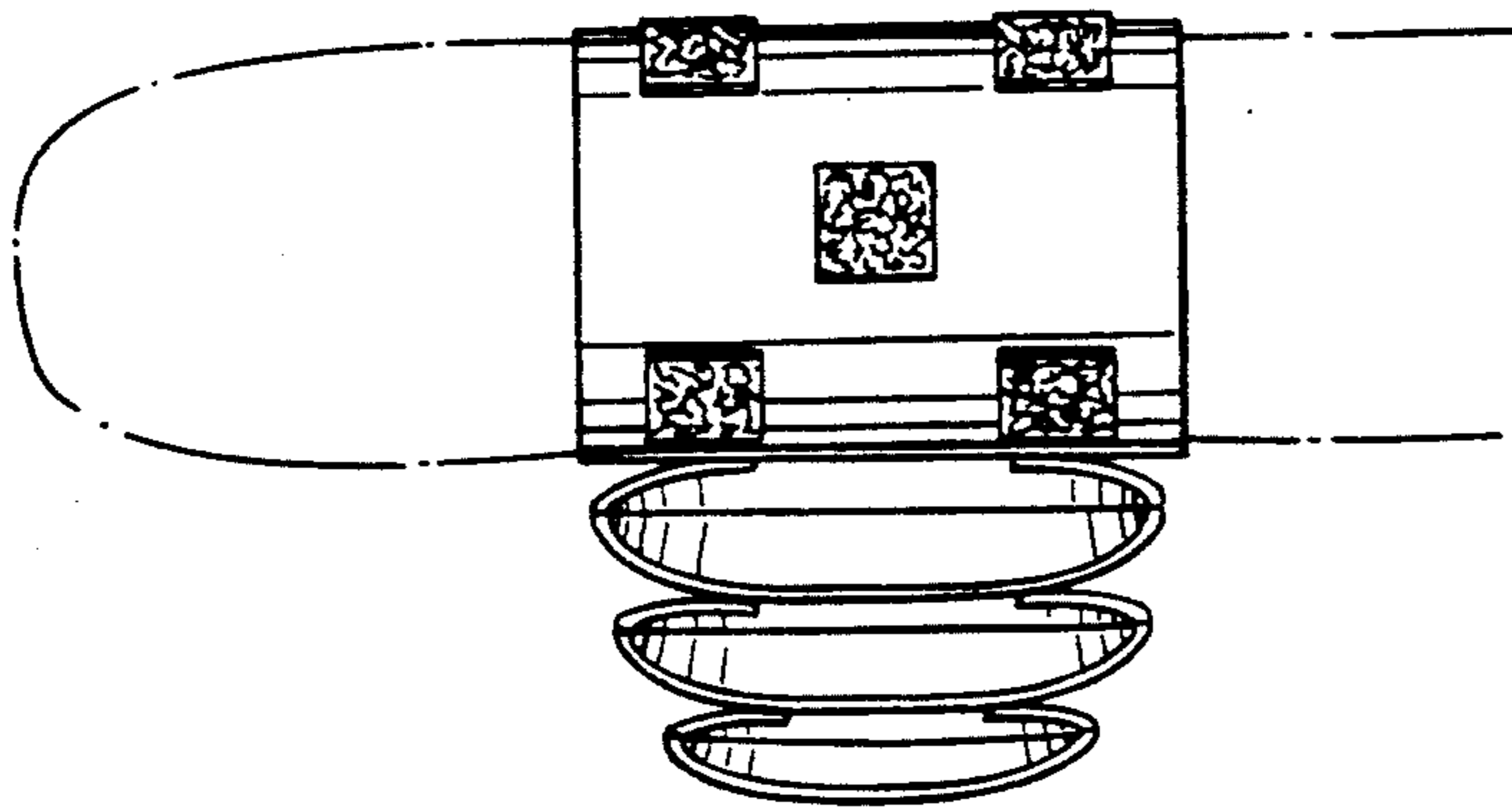

FIG. 3

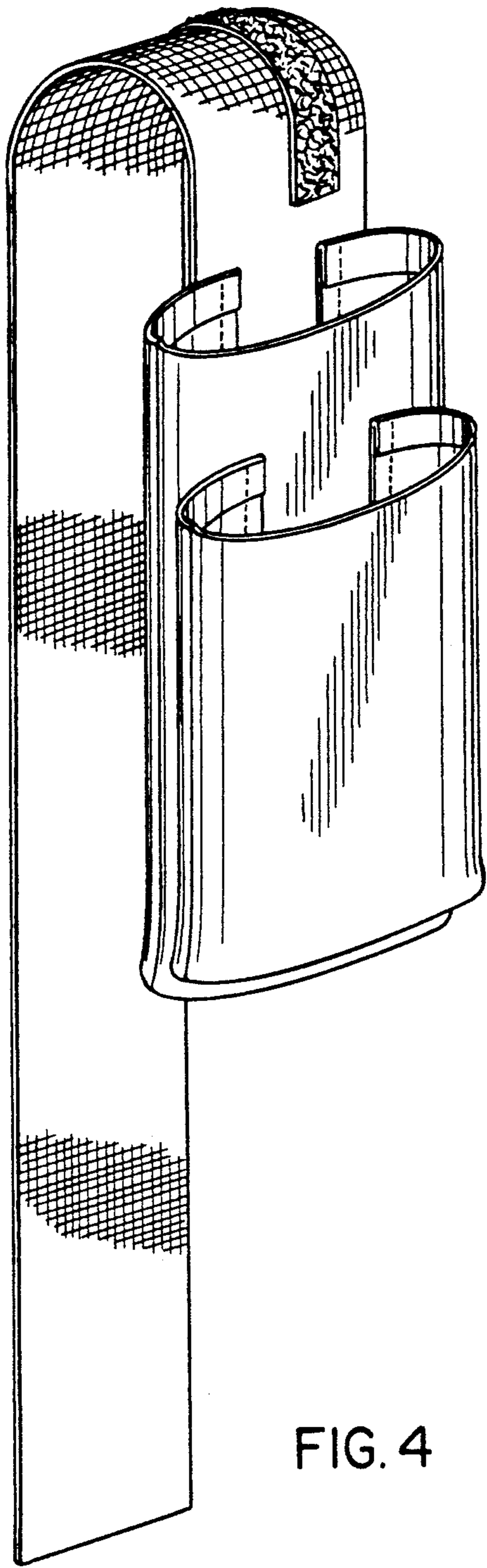

FIG. 4

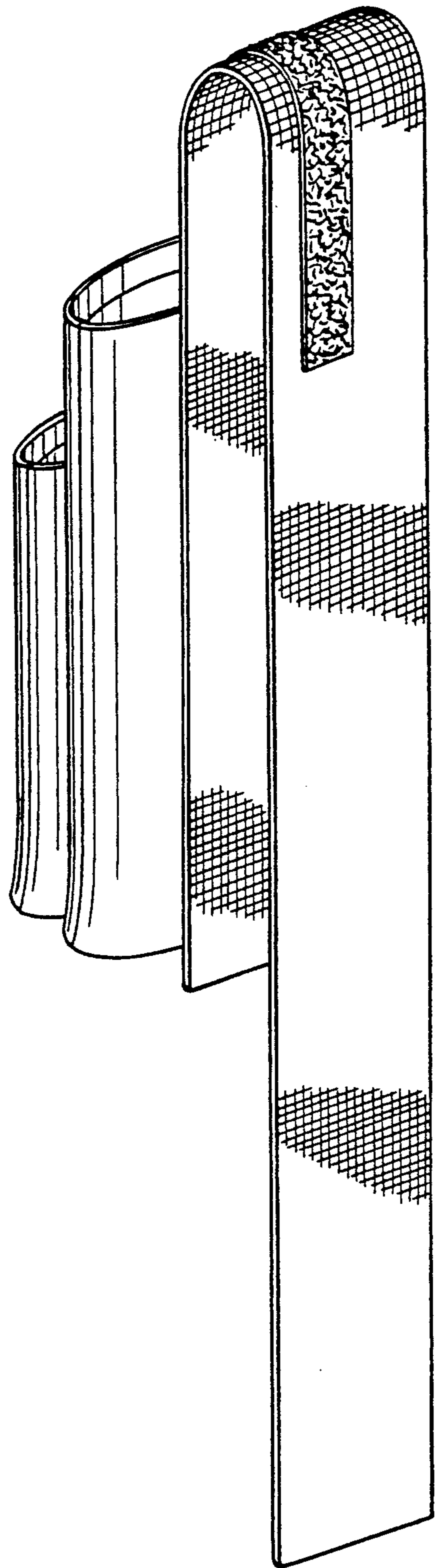

FIG. 5

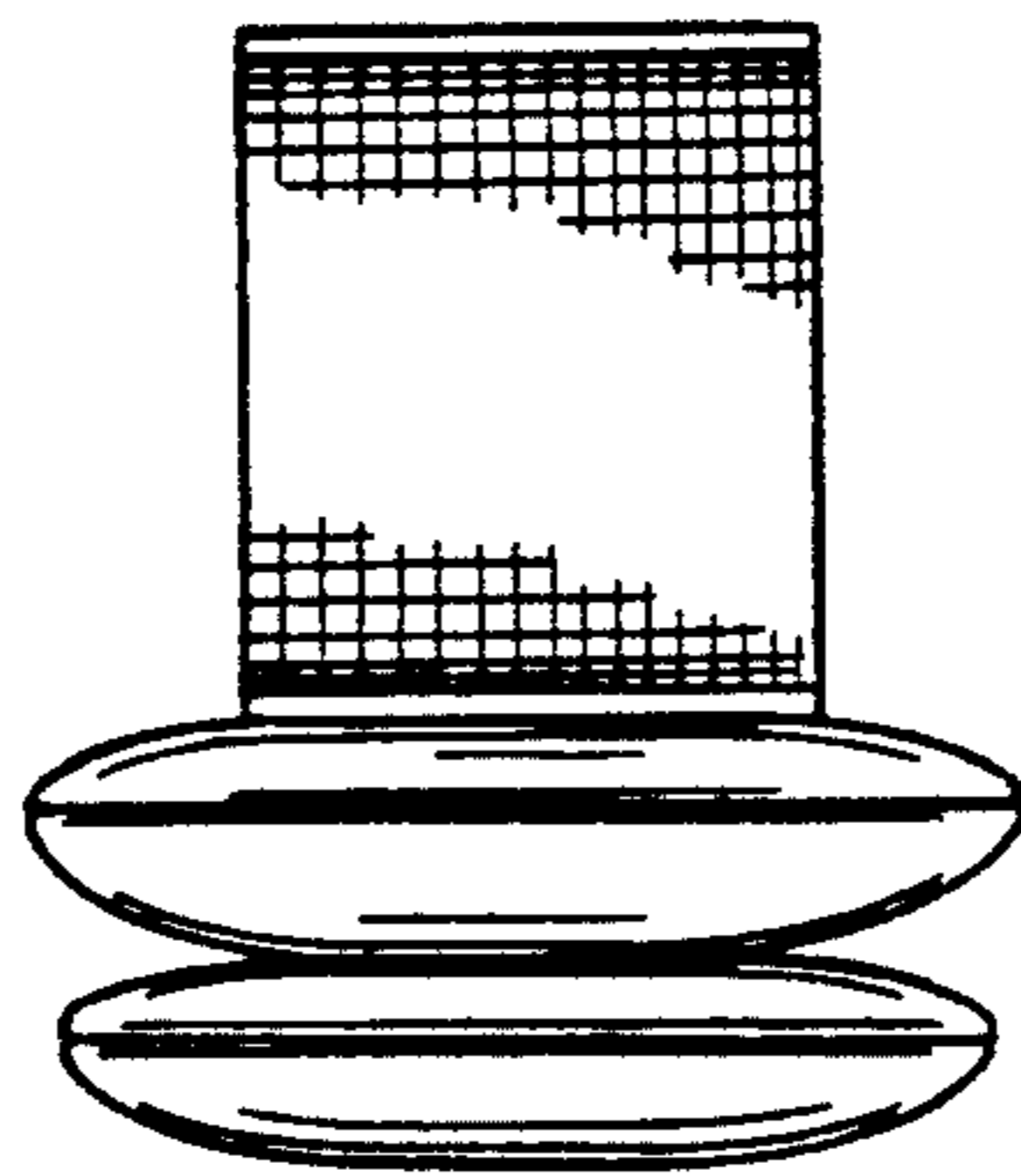

FIG. 6