



US00D346055S

United States Patent [19]

[11] Patent Number: **Des. 346,055**

Arnao

[45] Date of Patent: **** Apr. 12, 1994**

[54] **BRUSH CADDY**

[76] Inventor: **John V. Arnao**, 207 Sunset Dr.,
Forked River, N.J. 08731

[**] Term: **14 Years**

[21] Appl. No.: **627**

[22] Filed: **Oct. 22, 1992**

[52] U.S. Cl. **D32/54**

[58] Field of Search **D9/435, 455; 15/247,**
15/248.1, 264; 206/525; 248/210, 238;
220/697-702, 699, 904; D6/532, 533, 536;
D32/54, 53

[56] **References Cited**

U.S. PATENT DOCUMENTS

331,062	11/1885	Hull	15/264
450,462	4/1891	Inglis	15/264
844,177	2/1907	Neumeyer et al.	15/264
4,561,556	12/1985	Bendix	220/697

Primary Examiner—Wallace R. Burke
Assistant Examiner—Robin Taylor
Attorney, Agent, or Firm—S. Michael Bender

[57] **CLAIM**

The ornamental design for a brush caddy, as shown and described.

DESCRIPTION

FIG. 1 is a front elevational view of the brush caddy showing my new design;
FIG. 2 is a rear elevational view thereof;
FIG. 3 is a left side elevational view thereof;
FIG. 4 is a right side elevational view thereof;
FIG. 5 is a top plan view thereof;
FIG. 6 is a bottom plan view thereof; and,
FIG. 7 is a perspective view showing a use thereof.
The broken line showing of a brush and paint can is for illustrative purposes only and forms no part of the claimed design.

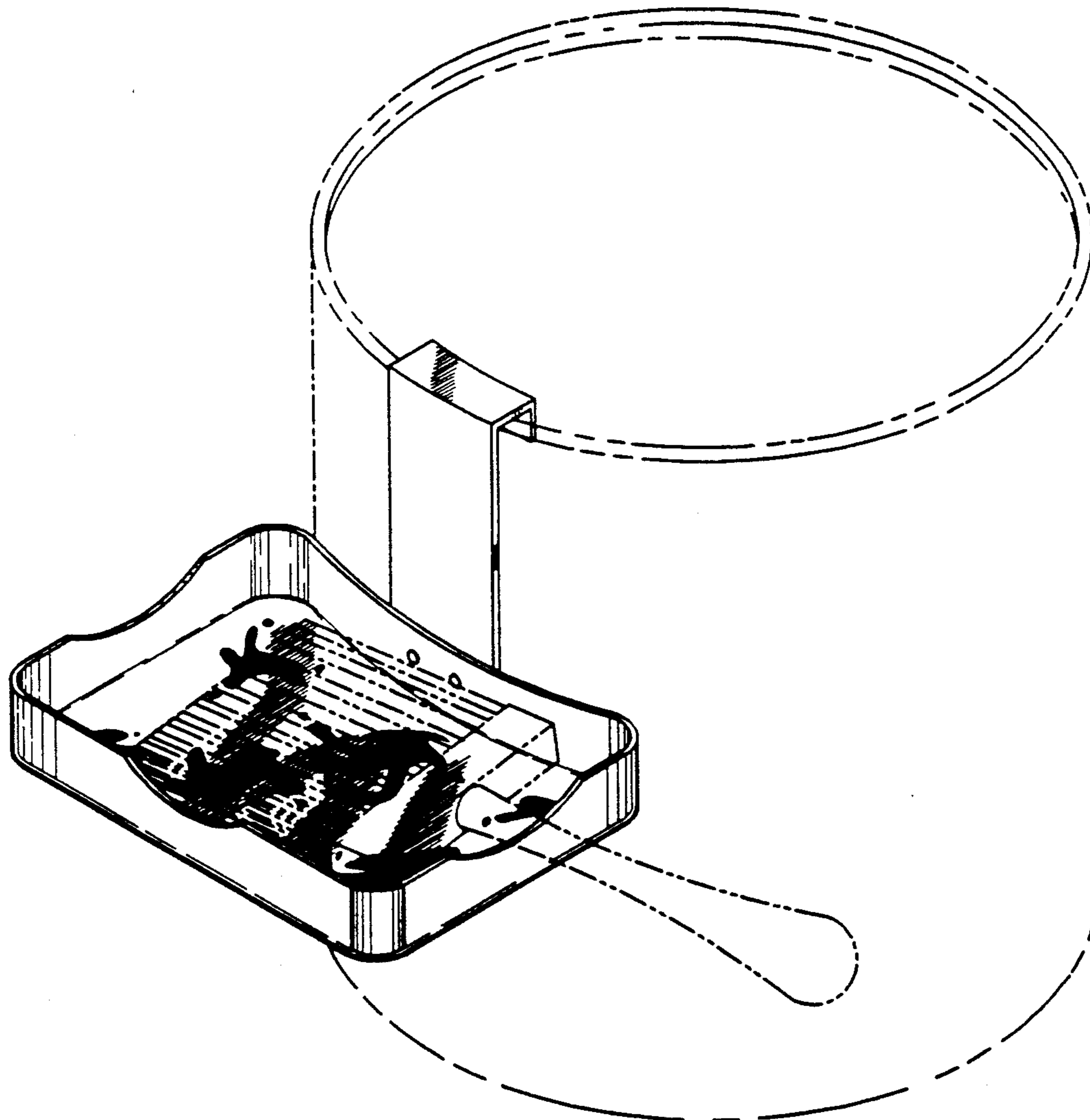

FIG. 1

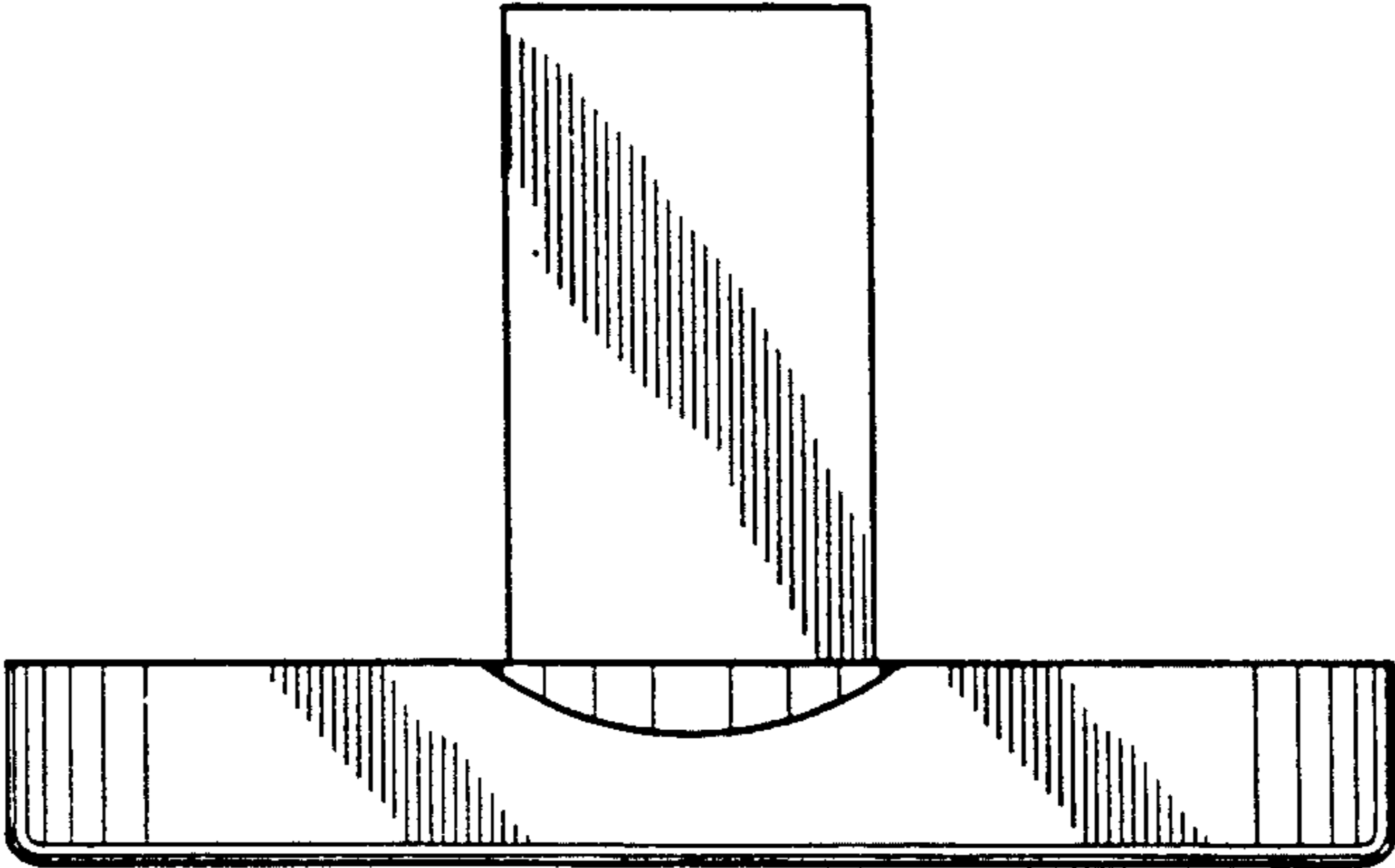

FIG. 2

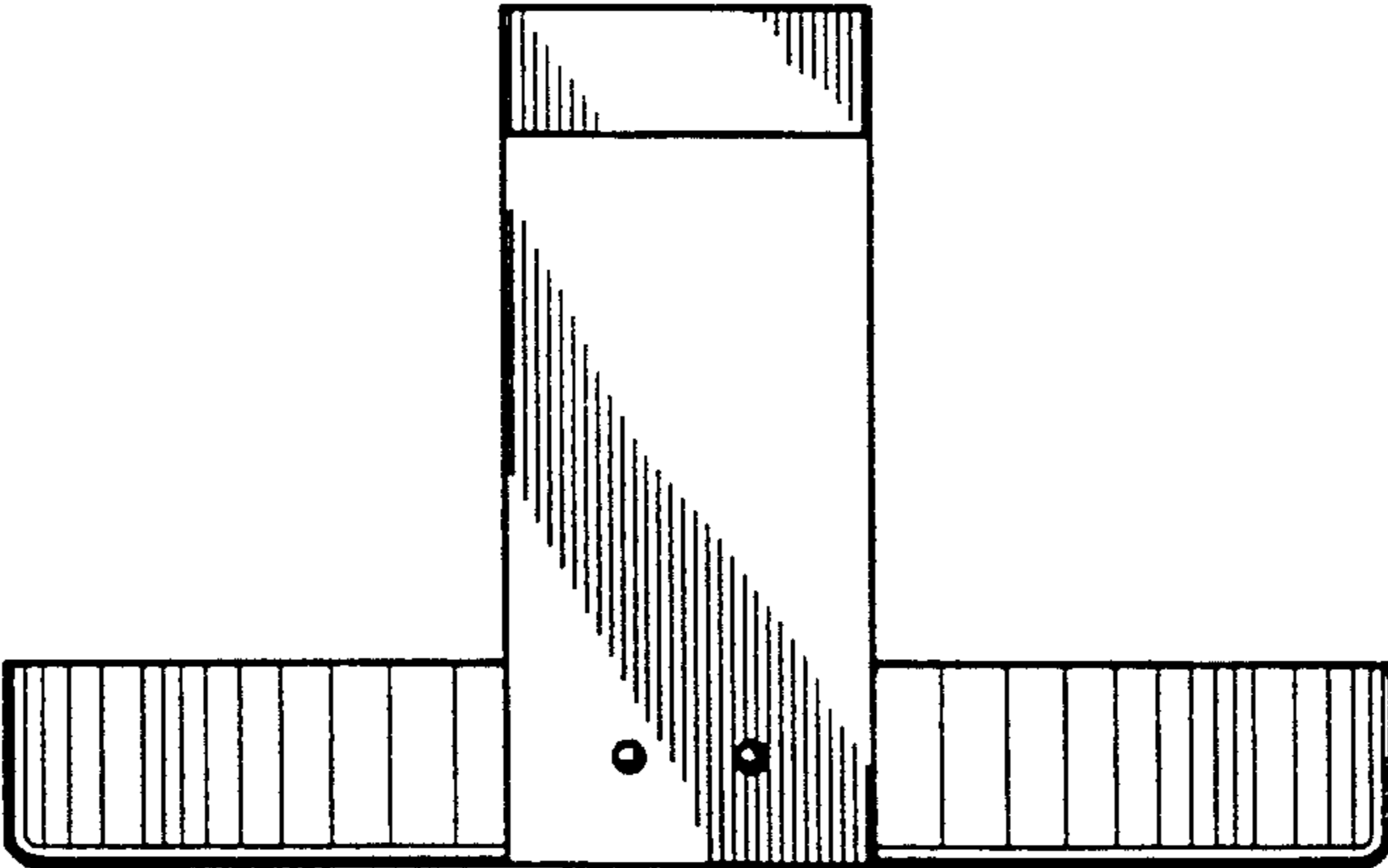

FIG. 3

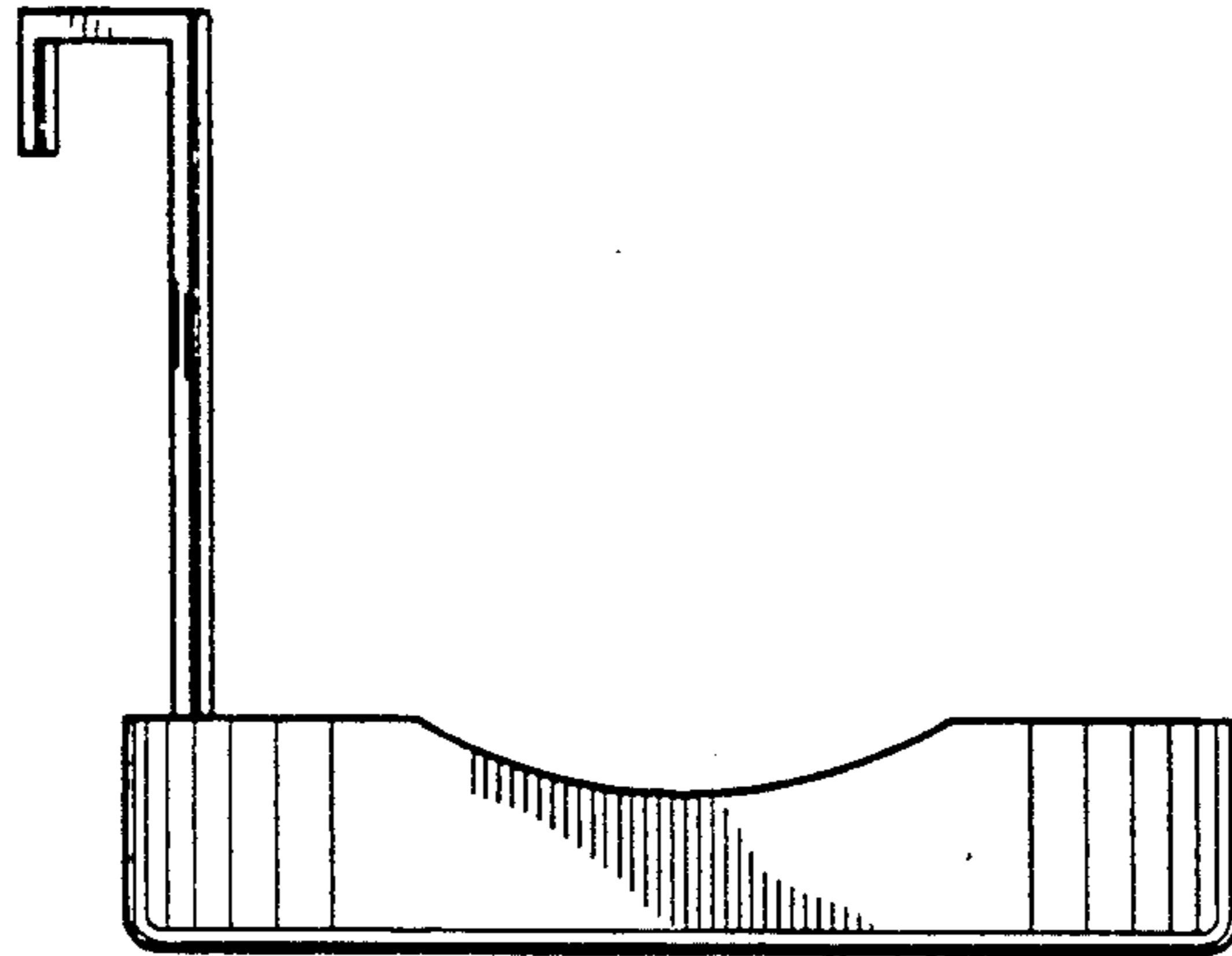

FIG. 4

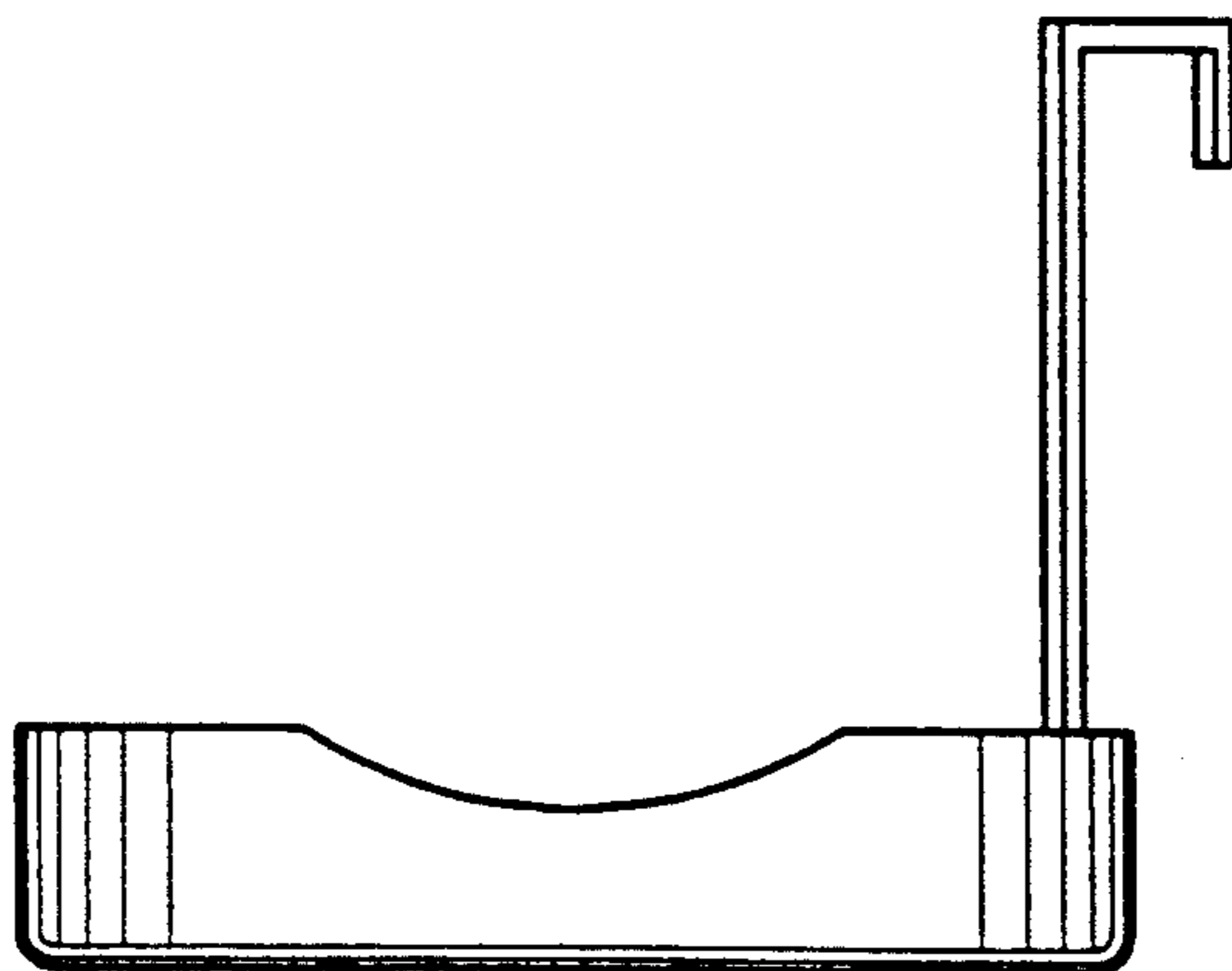

FIG. 5

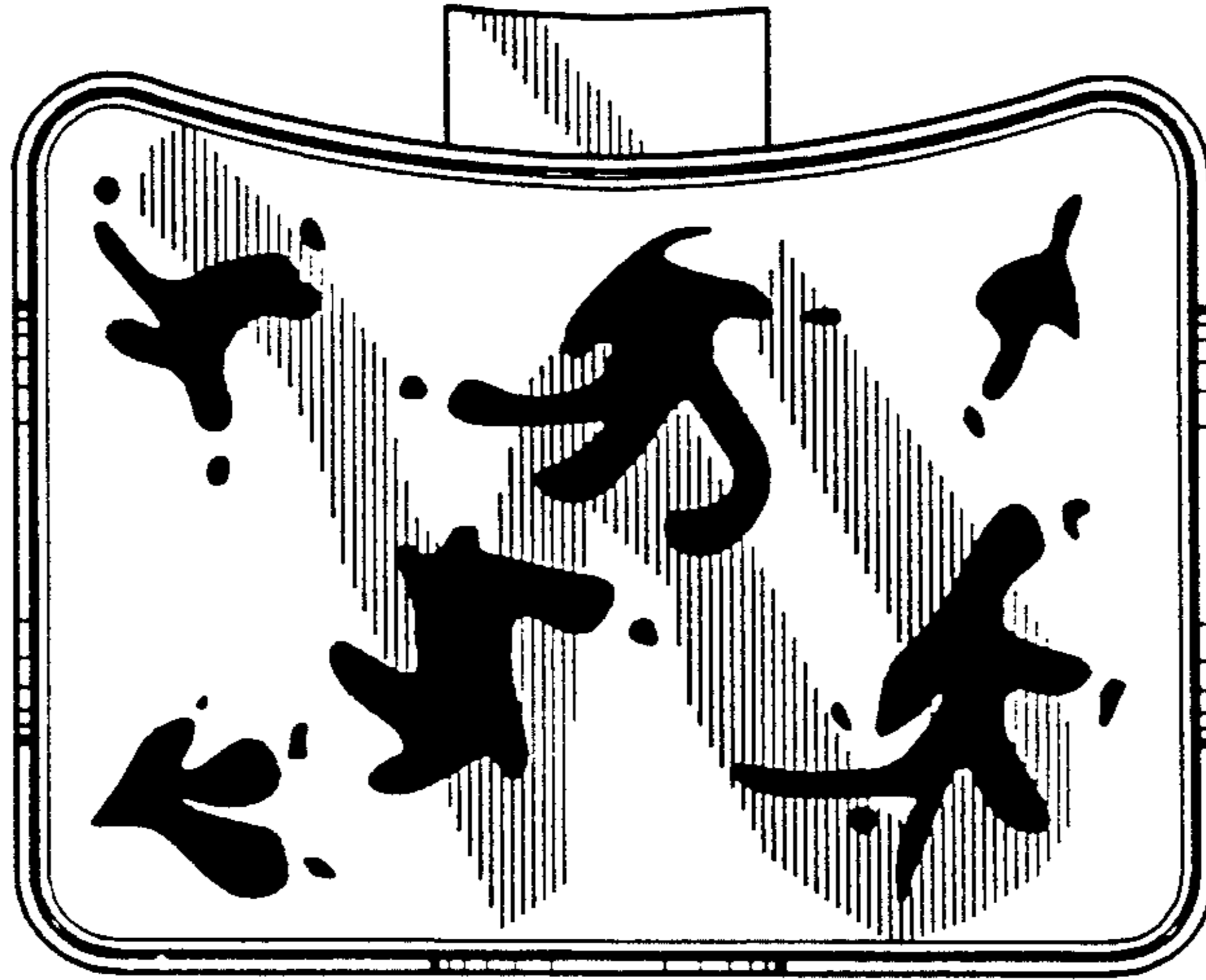

FIG. 6

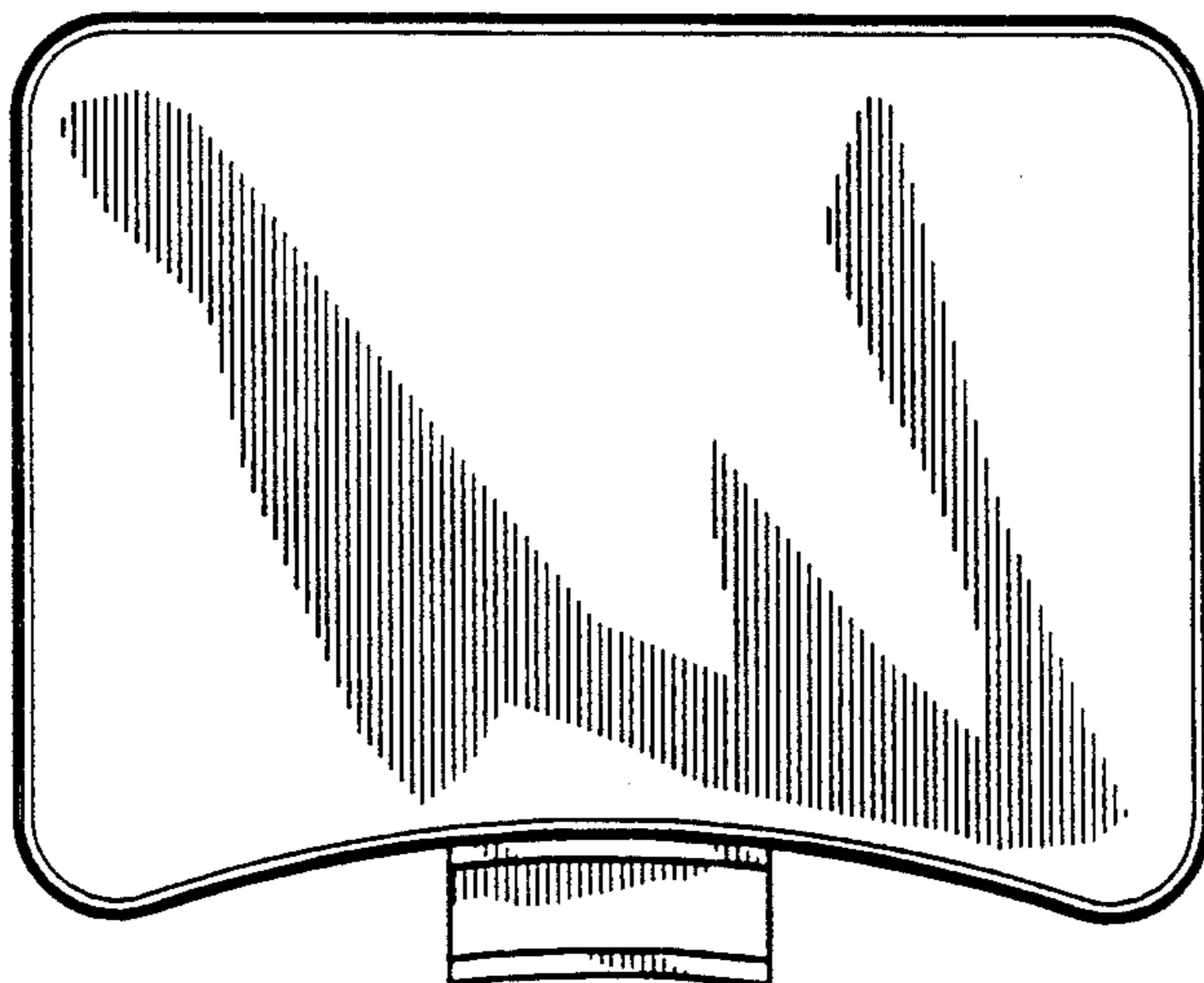

FIG. 7

