



US00D346030S

United States Patent [19]

[11] Patent Number: **Des. 346,030**

Tsai

[45] Date of Patent: **** Apr. 12, 1994**

[54] FOOT MASSAGER

D. 340,116 10/1993 Ohashi D24/213
D. 340,529 10/1993 Ohashi D24/200 X

[76] Inventor: **Chin C. Tsai**, No. 38, Lane 205, Hai Huan Street, Tainan, Taiwan

Primary Examiner—Stella Reid
Attorney, Agent, or Firm—Pro-Techtor International

[**] Term: **14 Years**

[57] **CLAIM**

[21] Appl. No.: **5,873**

The ornamental design for a foot massager, as shown.

[22] Filed: **Mar. 15, 1993**

DESCRIPTION

[52] U.S. Cl. **D24/213; D24/200**

[58] Field of Search 128/24 R, 24.1, 24.2,
128/25 B, 32, 41, 44, 51, 52, 60; D24/211, 212,
213, 214, 215

FIG. 1 is a perspective view of a foot massager showing my new design;

FIG. 2 is a front elevational view thereof;

FIG. 3 is a rear elevational view thereof;

FIG. 4 is a left side elevational view thereof;

FIG. 5 is a right side elevational view thereof;

FIG. 6 is a top plan view thereof; and,

FIG. 7 is a bottom plan view.

[56] **References Cited**

U.S. PATENT DOCUMENTS

D. 329,499 9/1992 Ohashi D24/213

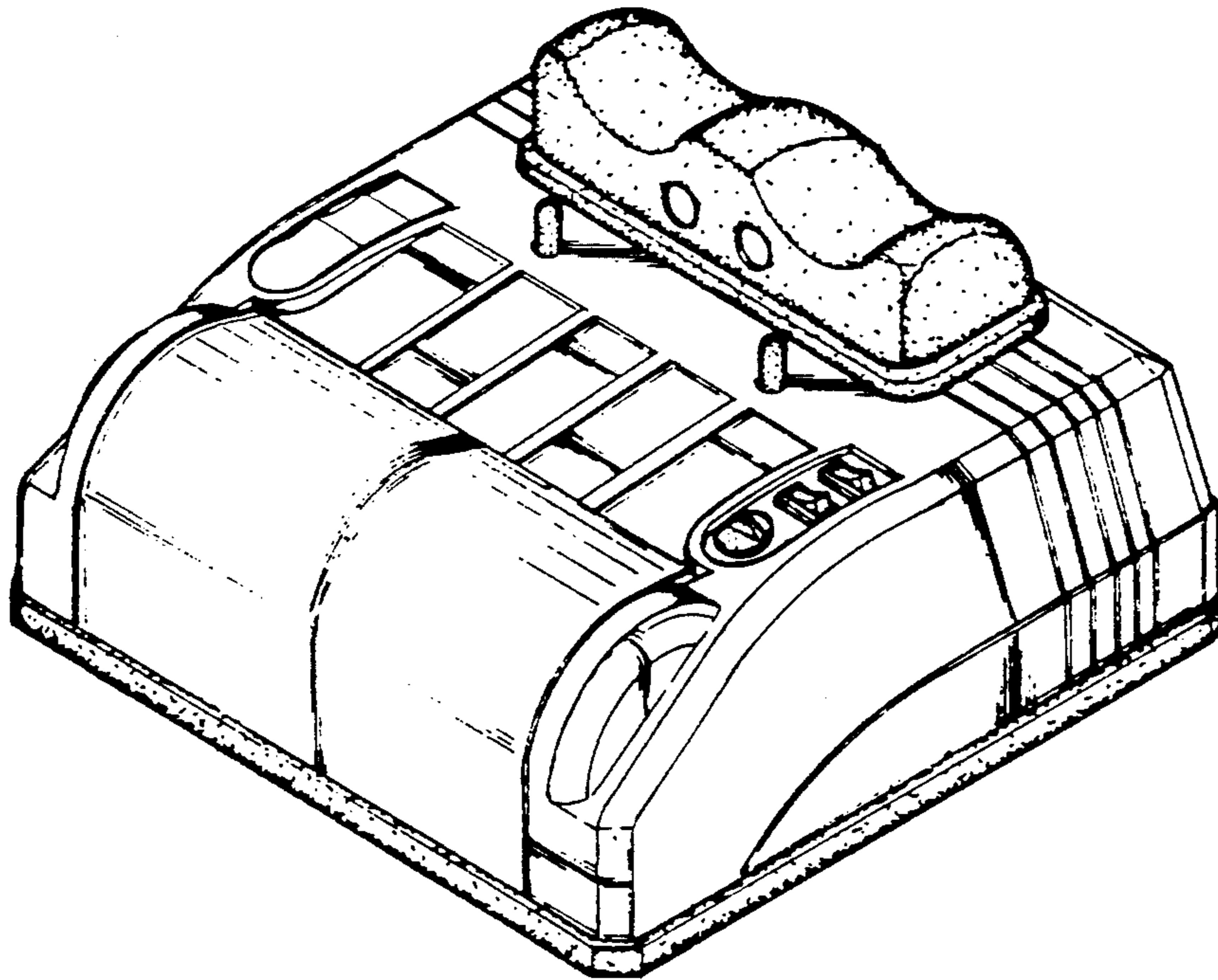

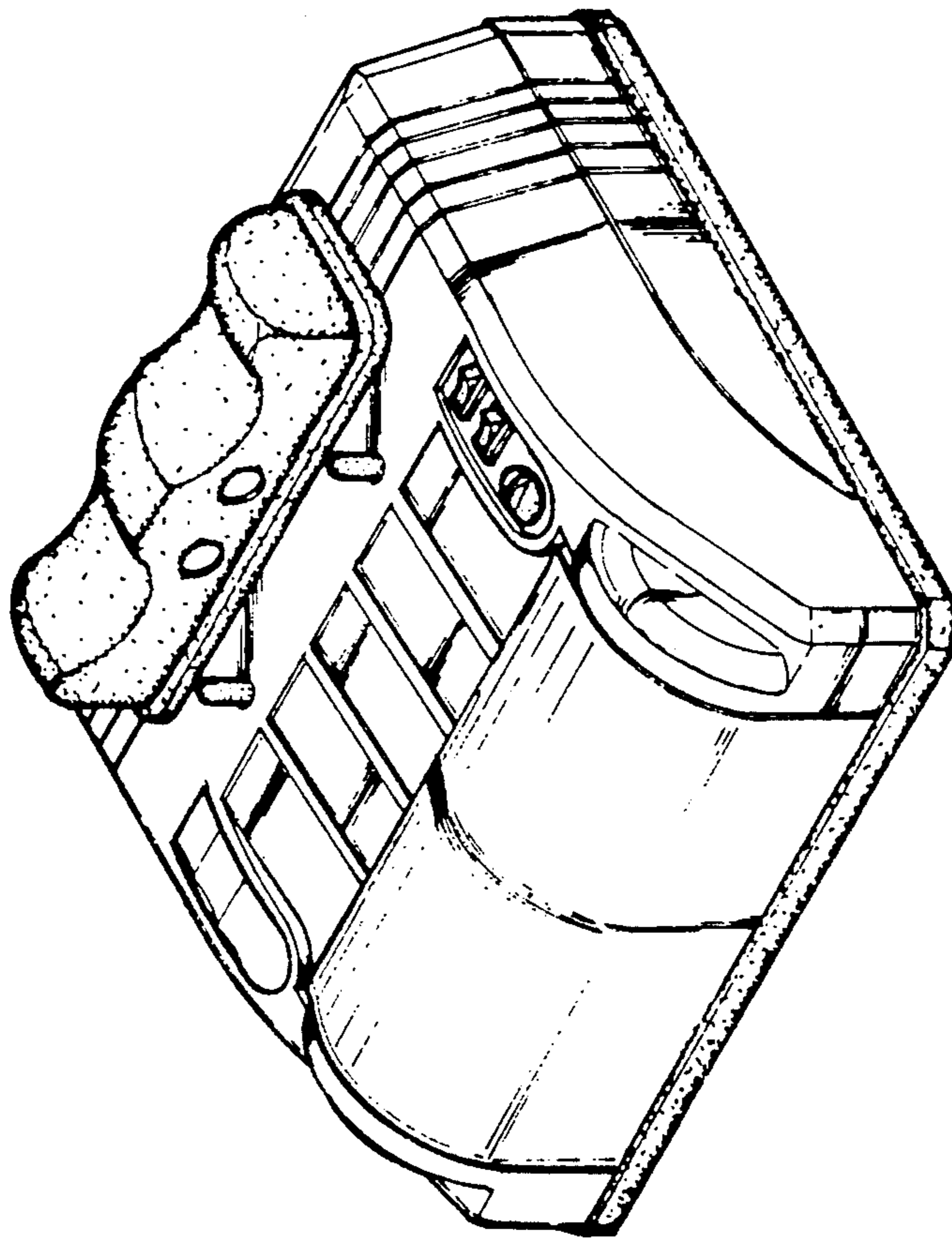

FIG. 1

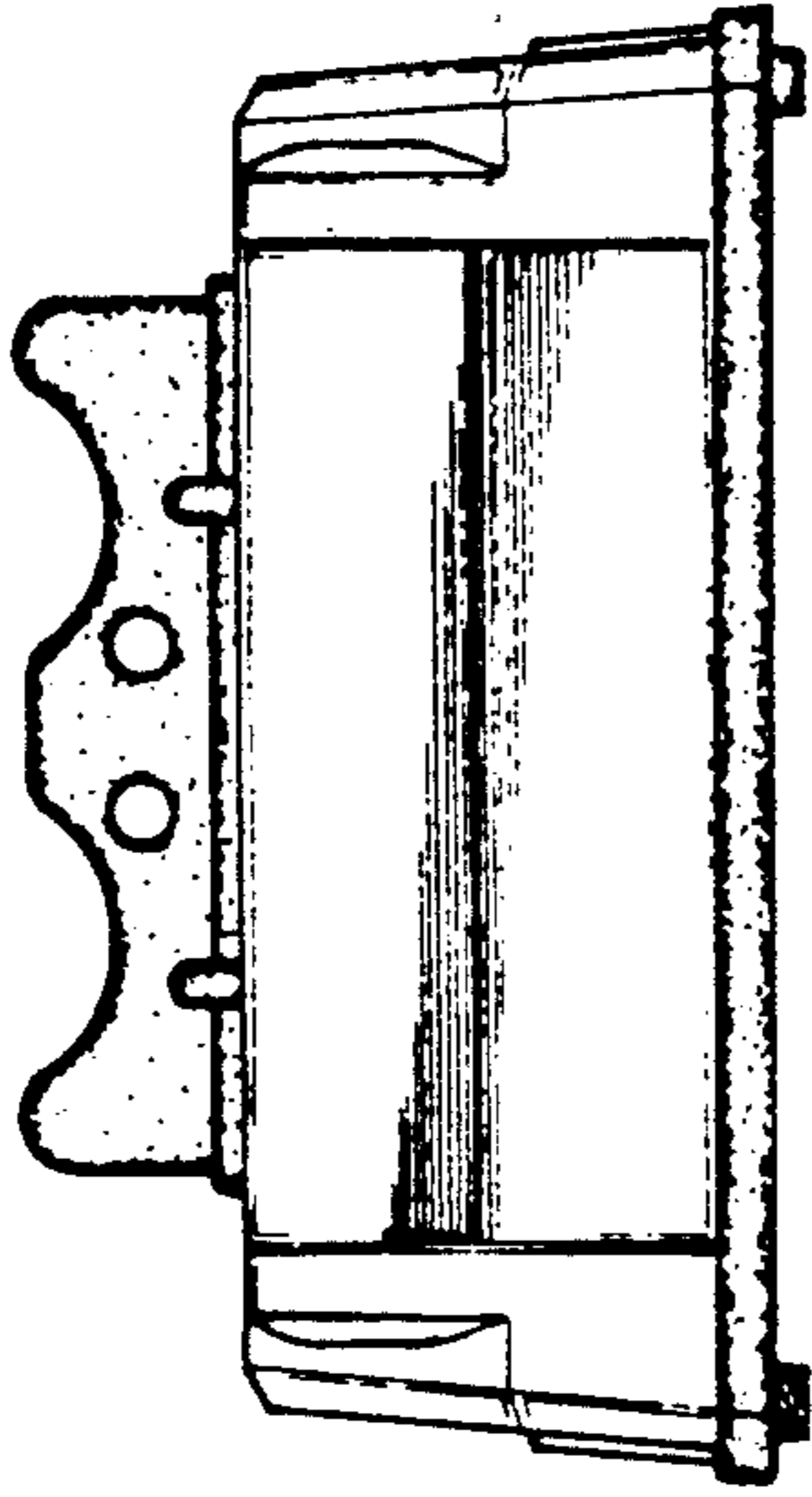

FIG. 2

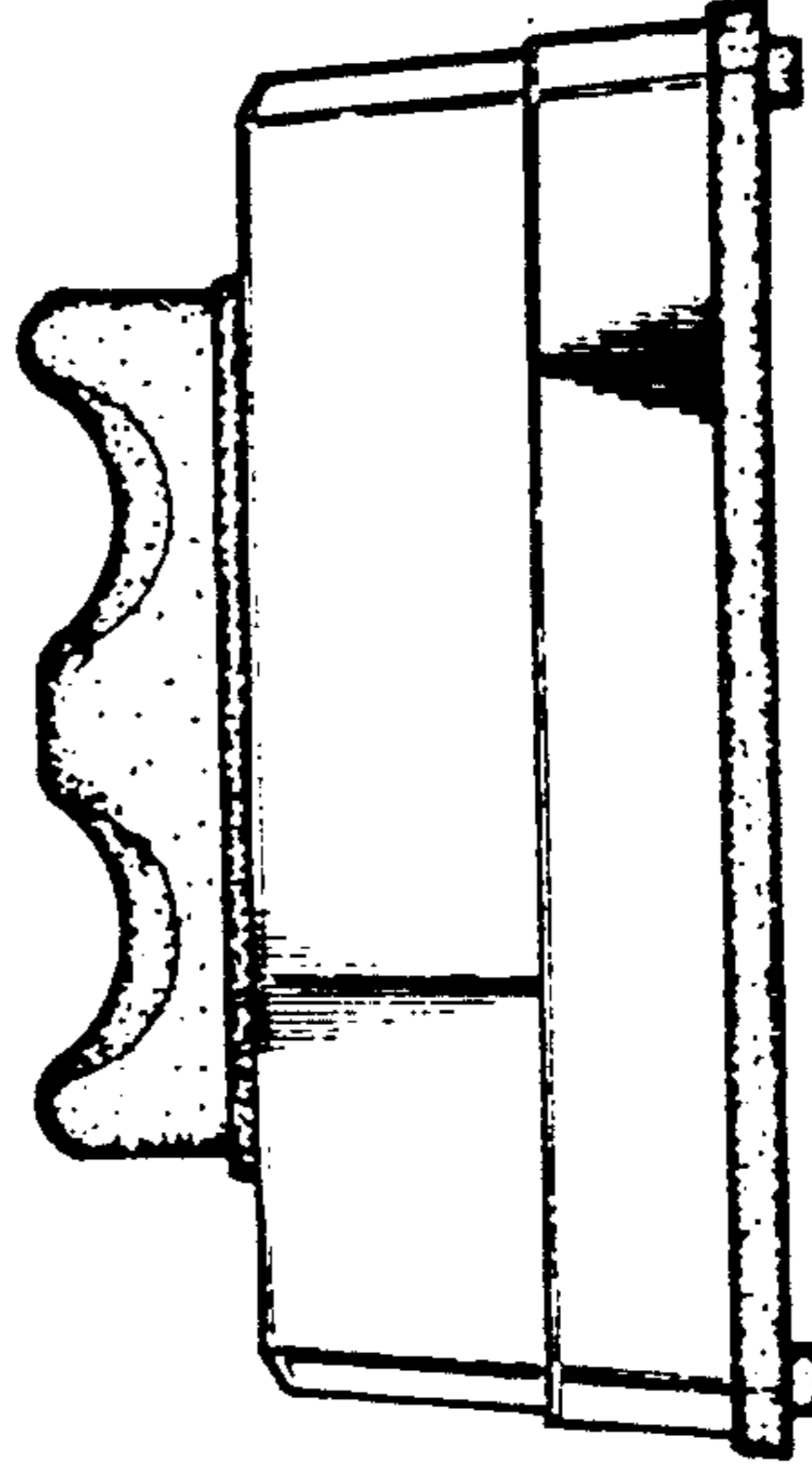

FIG. 3

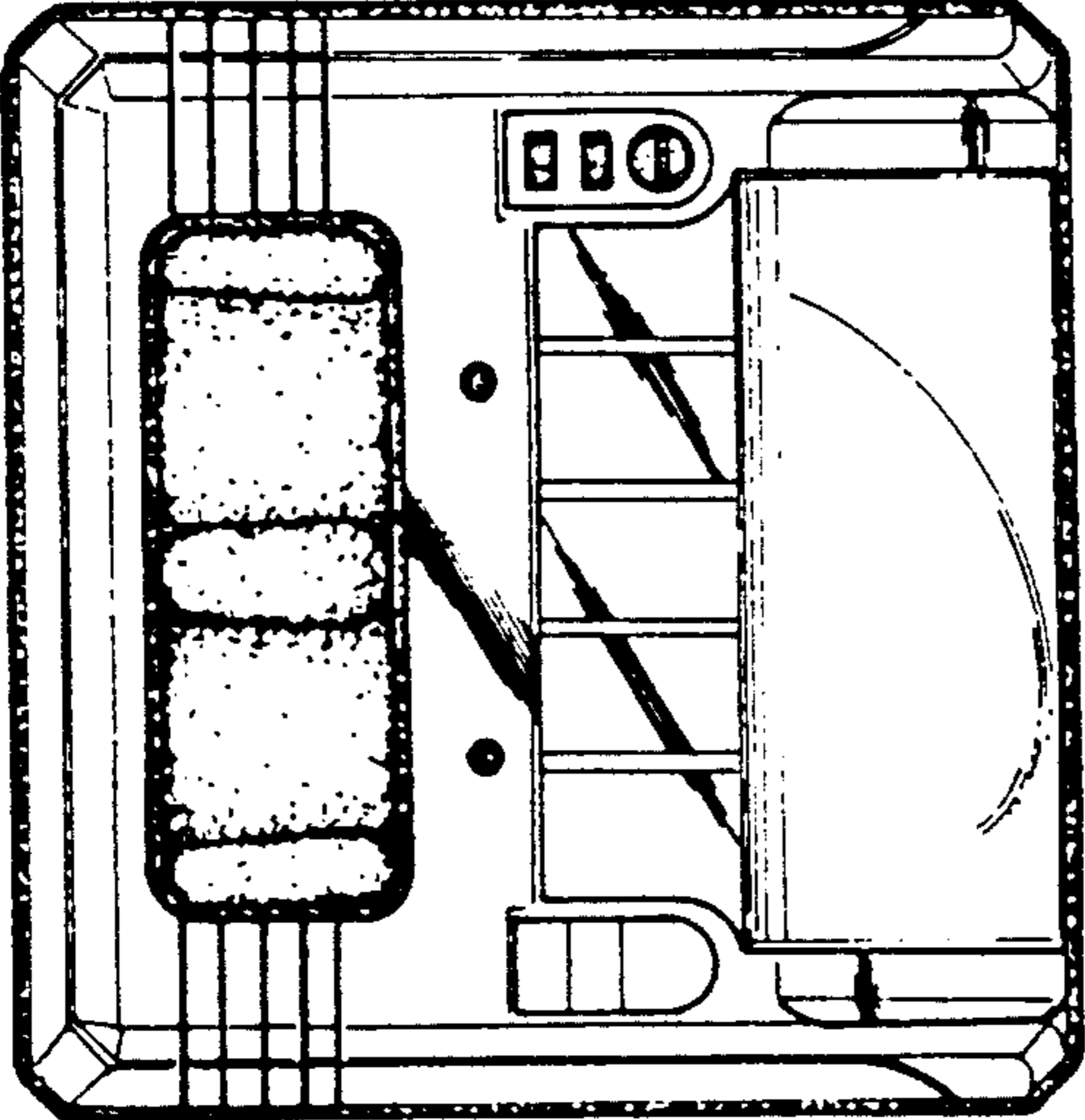

FIG. 6

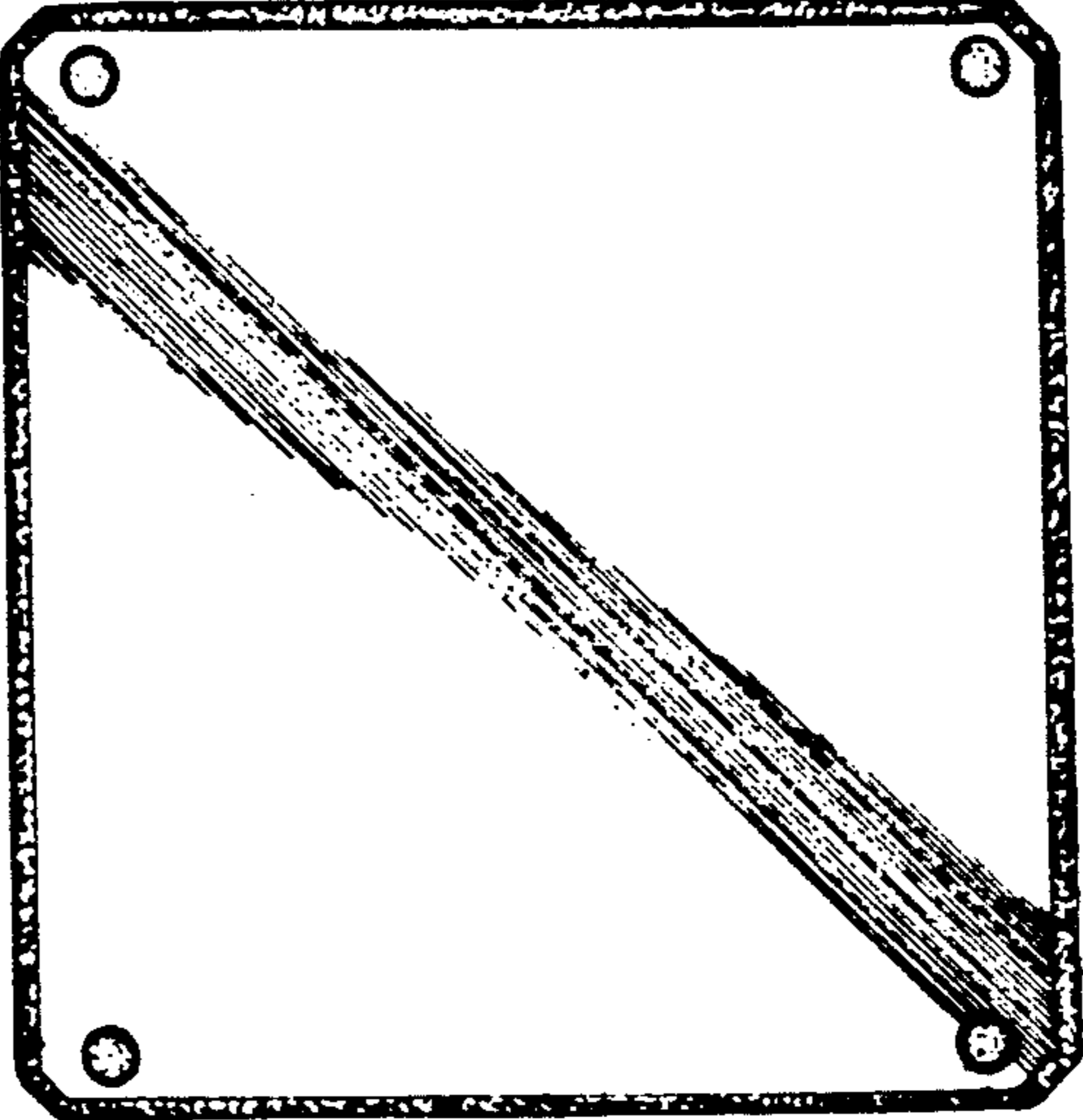

FIG. 7

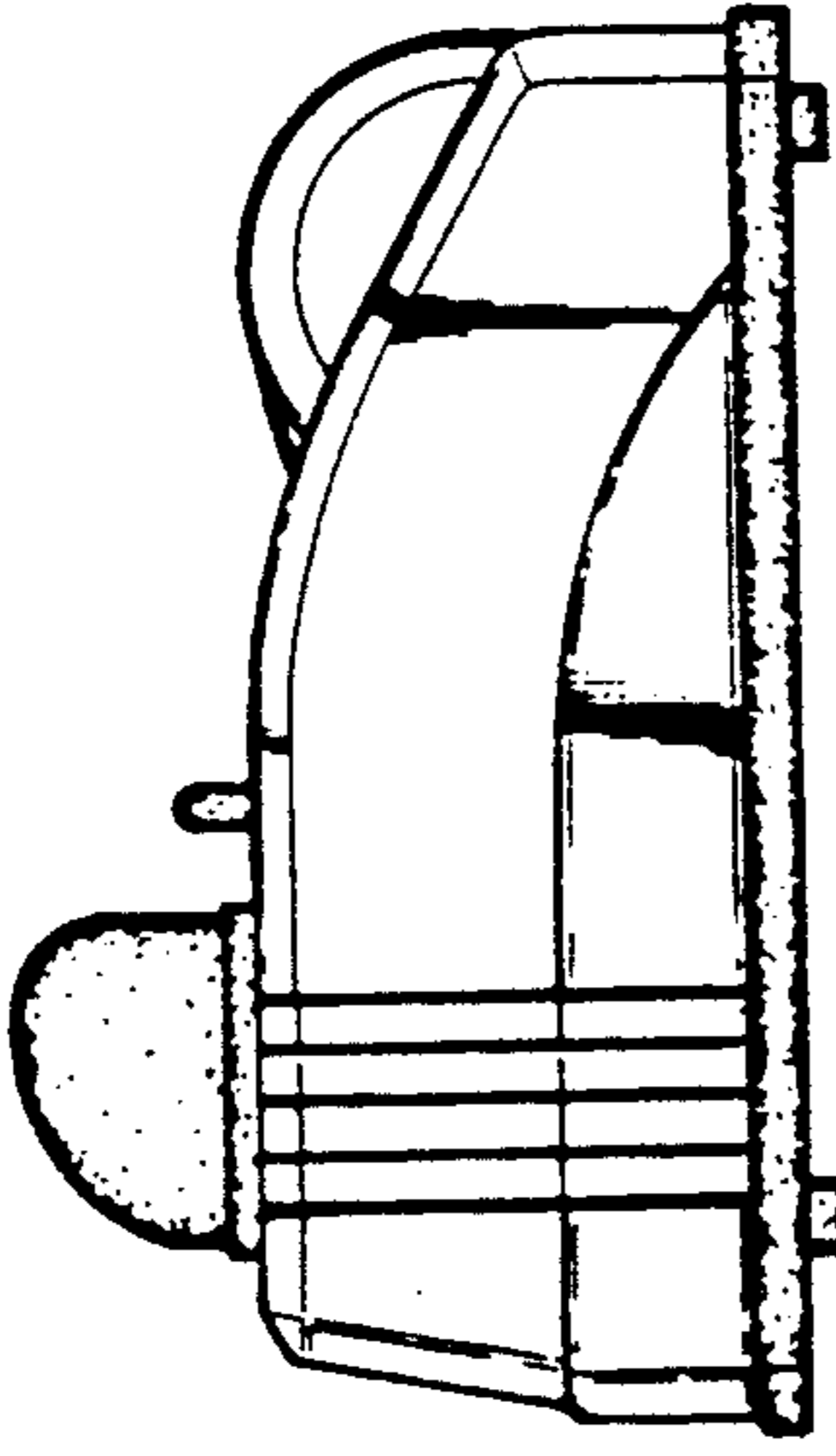

FIG. 4

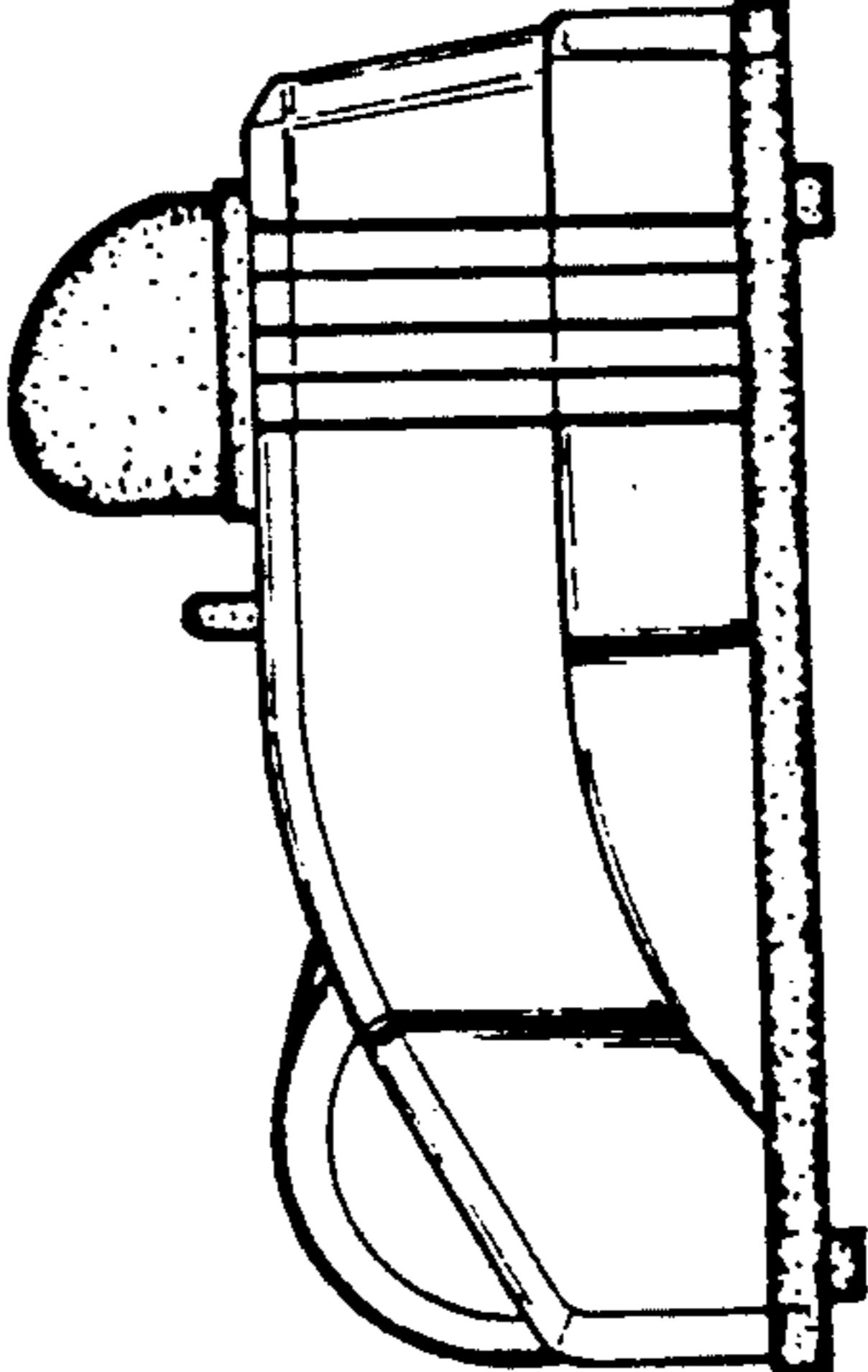

FIG. 5