



US00D346014S

# United States Patent [19]

[11] Patent Number: Des. 346,014

Berge et al.

[45] Date of Patent: \*\* Apr. 12, 1994

[54] **KITCHEN SINK**

[75] Inventors: **David R. Berge**, Saint Lazare; **Jeff P. Walz**, Toronto, both of Canada

[73] Assignee: **American Standard Inc.**, New York, N.Y.

[\*\*] Term: **14 Years**

[21] Appl. No.: **691,589**

[22] Filed: **Apr. 23, 1991**

[52] U.S. Cl. .... **D23/284**

[58] Field of Search ..... 4/580, 619, 630-636, 4/639, 640, 642, 650-660, DIG. 18; D23/271-275, 284-294

[56] **References Cited**

**U.S. PATENT DOCUMENTS**

D. 113,232	2/1939	Love	.....	D23/294
D. 198,305	6/1964	Graning, Jr.	.....	D23/290
D. 218,606	9/1970	Lein	.....	D23/284
D. 226,378	2/1973	Doman	.....	D23/290
D. 234,199	1/1975	Stairs, Jr.	.....	D23/294
D. 234,201	1/1975	Stairs, Jr.	.....	D23/290
D. 234,427	3/1975	Stairs, Jr.	.....	D23/294
D. 234,464	3/1975	Stairs, Jr.	.....	D23/290
D. 326,902	6/1992	Bonnell	.....	D23/284
4,336,620	6/1982	Gresh	.....	4/619 X

**OTHER PUBLICATIONS**

Spring/Summer 1991 edition of Sears Catalog (p. 1020).

*Primary Examiner*—James R. Largen

*Attorney, Agent, or Firm*—Elaine B. Robinson; Ann M. Knab

[57] **CLAIM**

The ornamental design for a kitchen sink, as shown and described.

**DESCRIPTION**

FIG. 1 is a top, front and left side perspective view of a kitchen sink showing our new design;

FIG. 2 is a top plan view thereof;  
 FIG. 3 is a front elevational view thereof;  
 FIG. 4 is a left side elevational view thereof;  
 FIG. 5 is a right side elevational view thereof;  
 FIG. 6 is a rear elevational view thereof;  
 FIG. 7 is a bottom plan view thereof;  
 FIG. 8 is a cross sectional view taken on line 8—8 of FIG. 2;  
 FIG. 9 is a top, front and left side perspective view of a second embodiment thereof;  
 FIG. 10 is a top plan view of FIG. 9;  
 FIG. 11 is a front elevational view of FIG. 9;  
 FIG. 12 is a left side elevational view of FIG. 9;  
 FIG. 13 is a right side elevational view of FIG. 9;  
 FIG. 14 is a rear elevational view of FIG. 9;  
 FIG. 15 is a bottom plan view of FIG. 9;  
 FIG. 16 is a cross sectional view taken on line 16—16 of FIG. 10;  
 FIG. 17 is a top, front and left side perspective view of a third embodiment thereof, wherein this embodiment differs from the first embodiment by the addition of an external shell;  
 FIG. 18 is a top plan view of FIG. 17;  
 FIG. 19 is a front elevational view of FIG. 17;  
 FIG. 20 is a left side elevational view of FIG. 17;  
 FIG. 21 is a right side elevational view of FIG. 17;  
 FIG. 22 is a rear elevational view of FIG. 17;  
 FIG. 23 is a bottom plan view of FIG. 17;  
 FIG. 24 is a cross sectional view taken on line 25—25 of FIG. 18;  
 FIG. 25 is a top, front and left side perspective view of a fourth embodiment thereof, wherein this embodiment differs from the second embodiment by the addition of an external shell;  
 FIG. 26 is a front elevational view of FIG. 25;  
 FIG. 27 is a top plan view of FIG. 25;  
 FIG. 28 is a left side elevational view of FIG. 25;  
 FIG. 29 is a right side elevational view of FIG. 25;  
 FIG. 30 is a rear elevational view of FIG. 25;  
 FIG. 31 is a bottom plan view of FIG. 25; and  
 FIG. 32 is a cross sectional view taken on line 32—32 of FIG. 26.

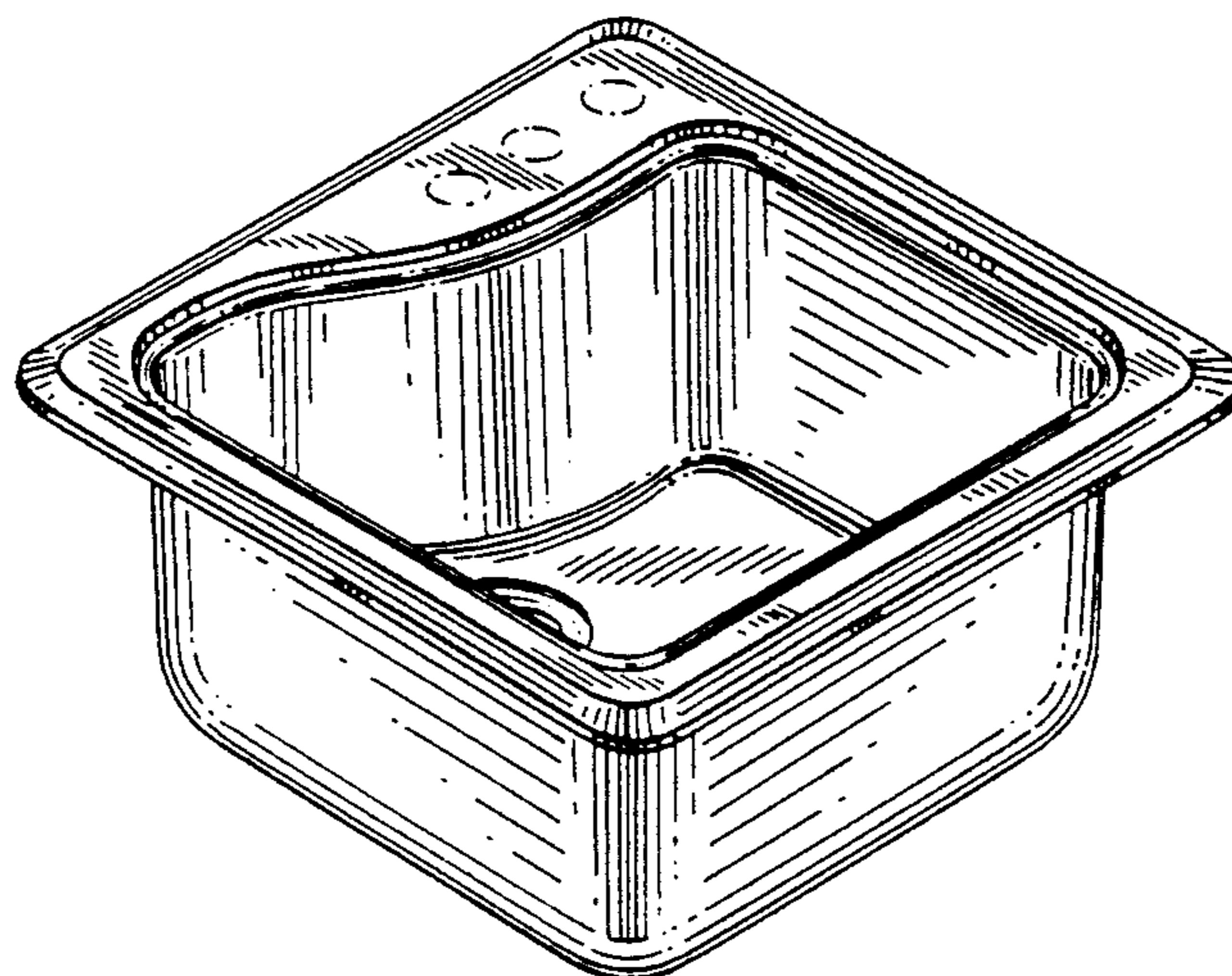

FIG. 1

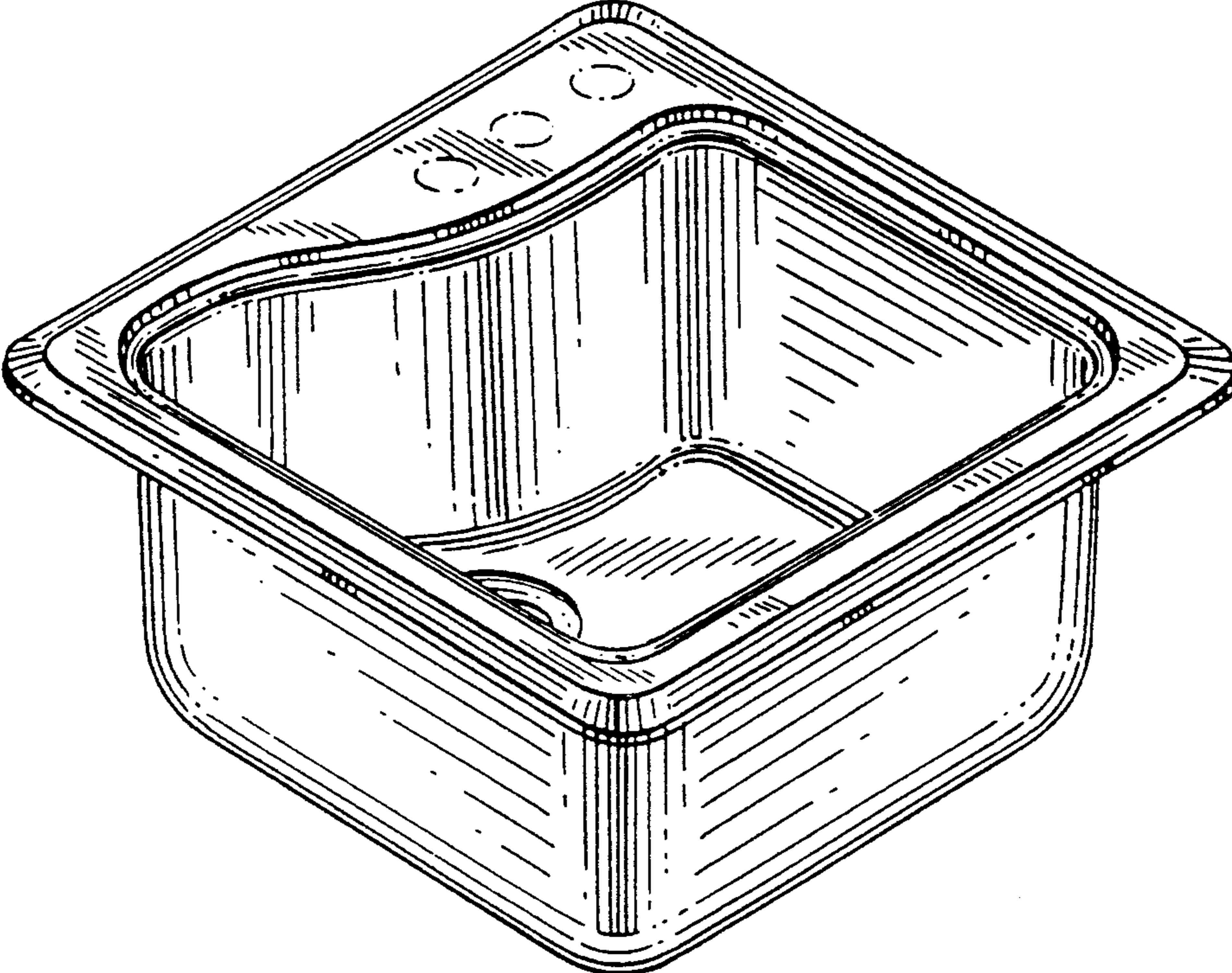

FIG. 8

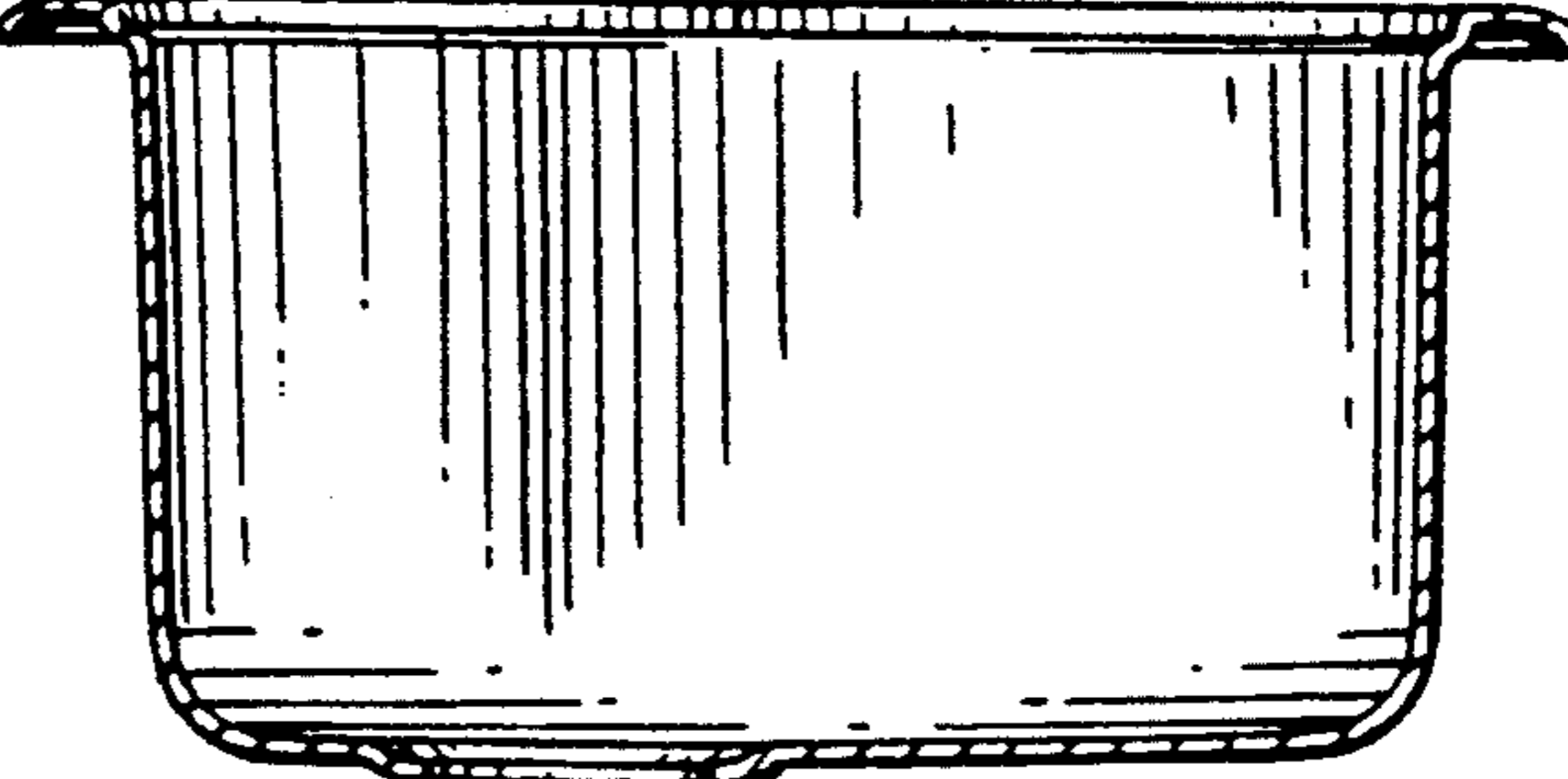

FIG.2

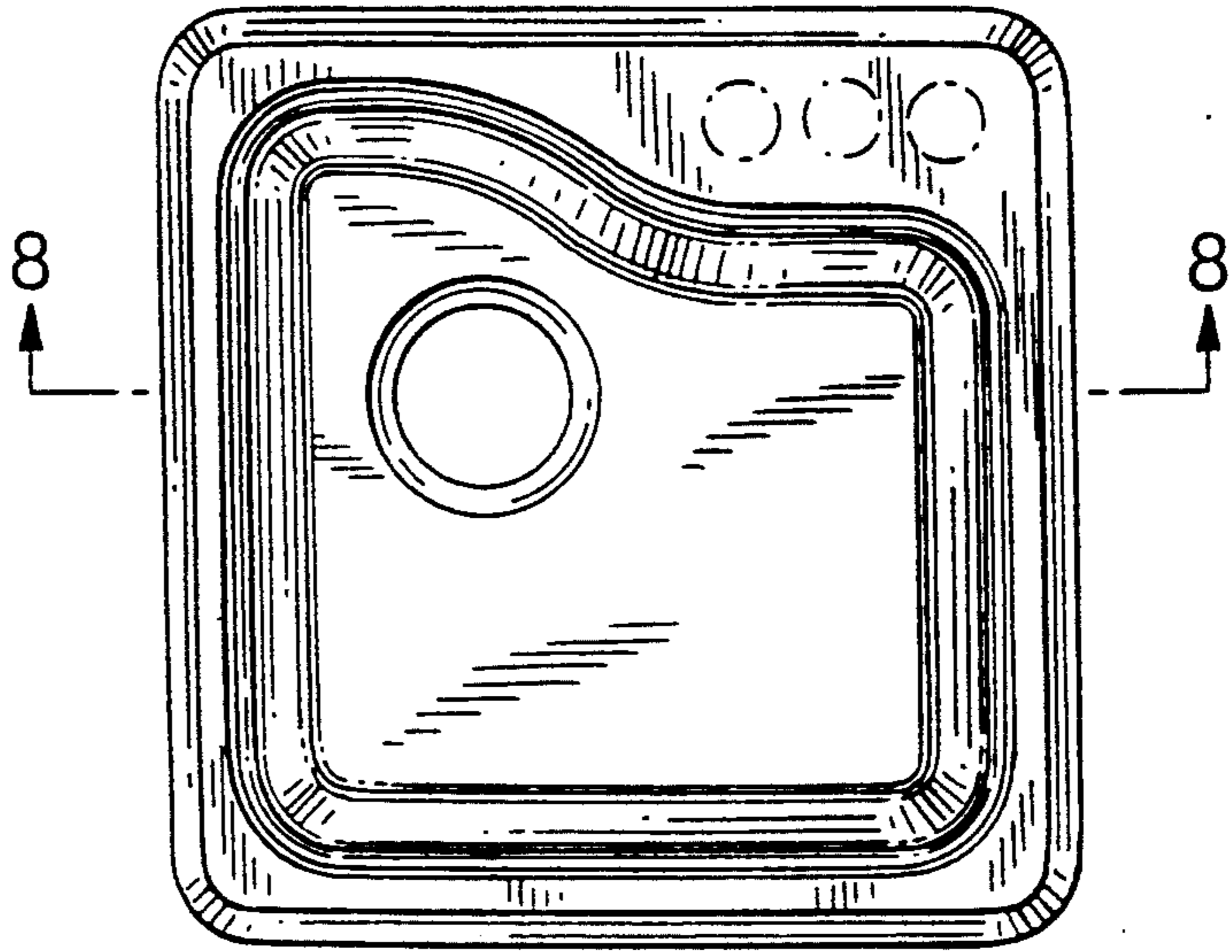

FIG.3

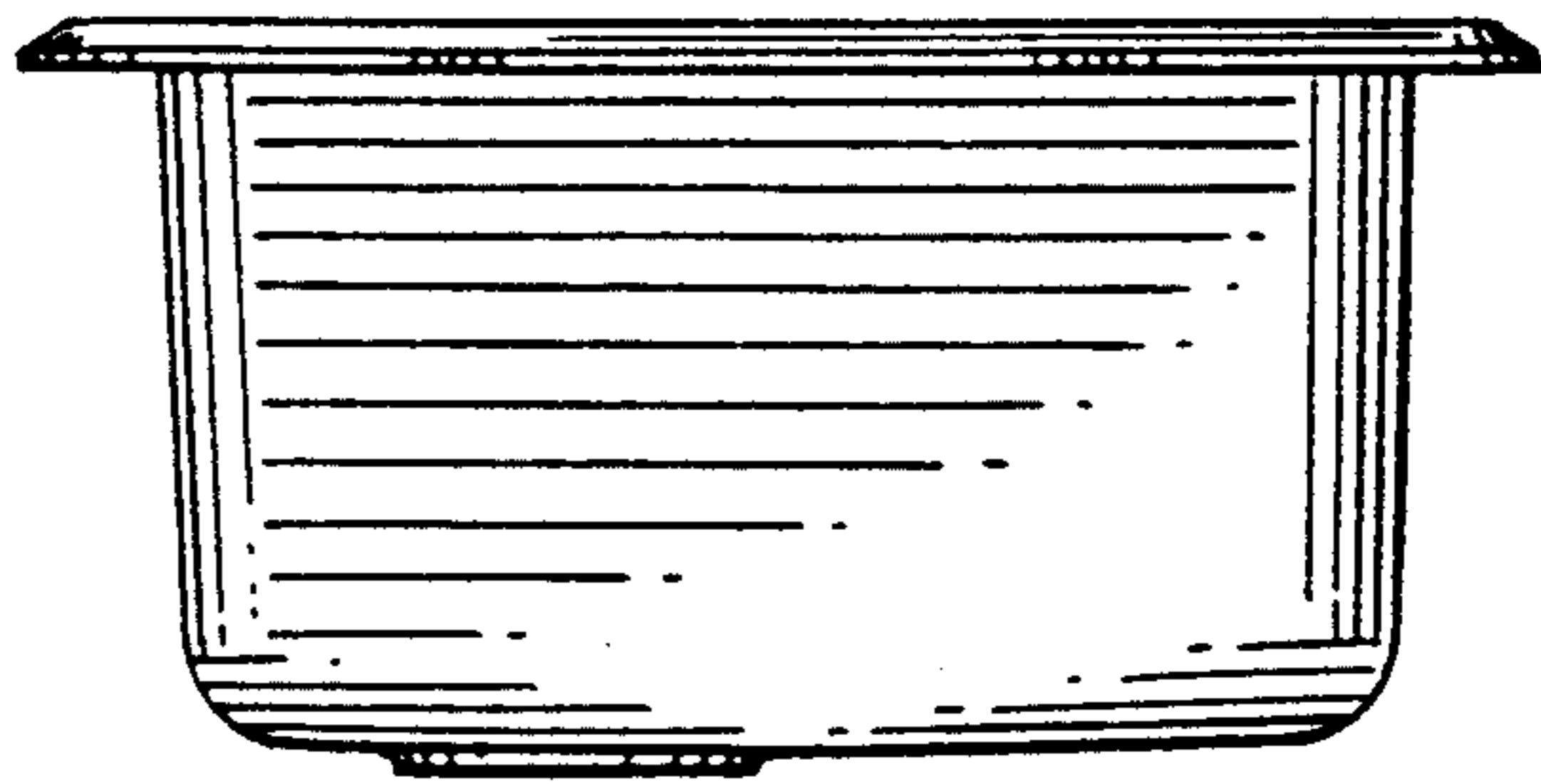

FIG.4

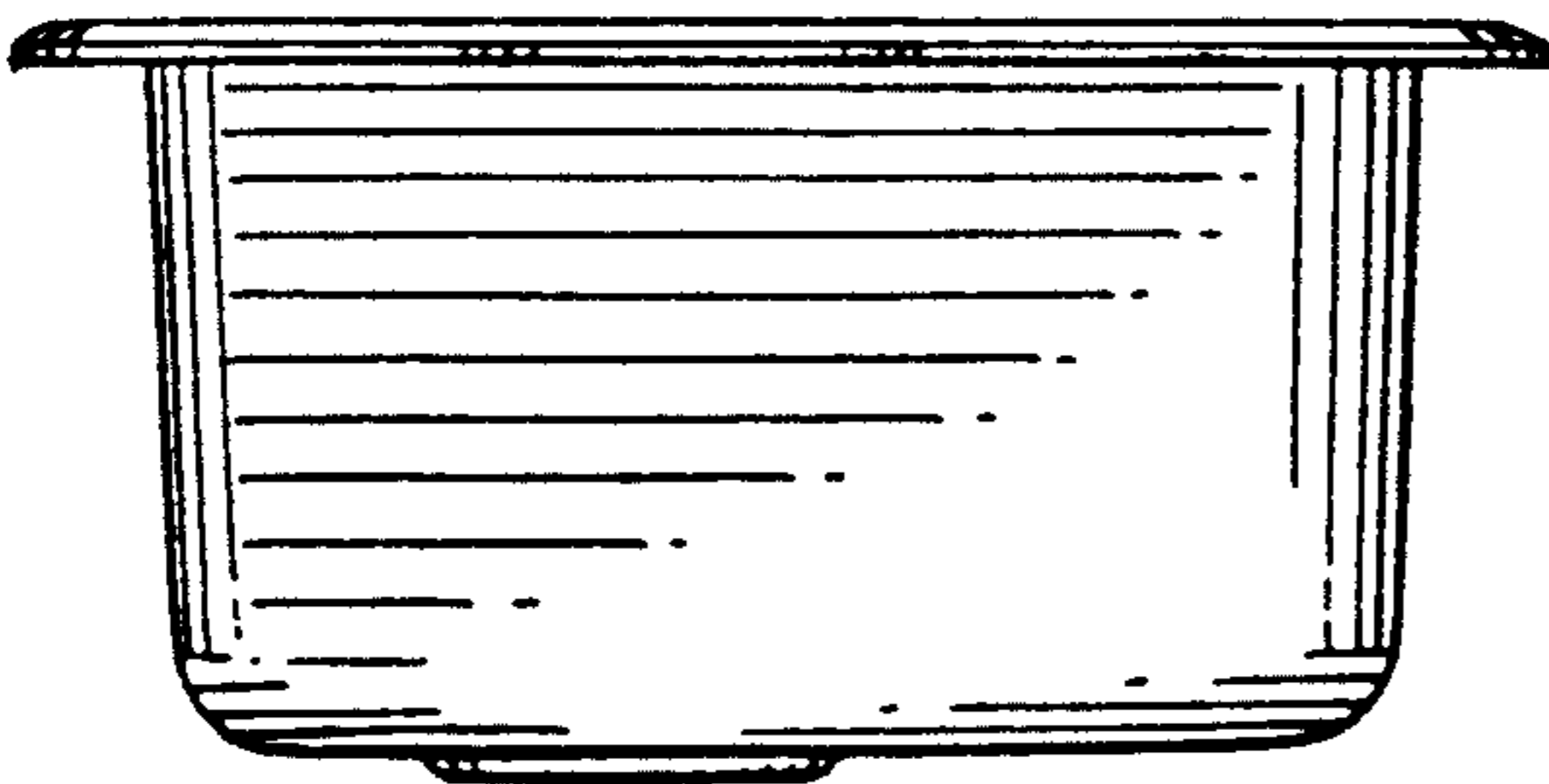

FIG.5

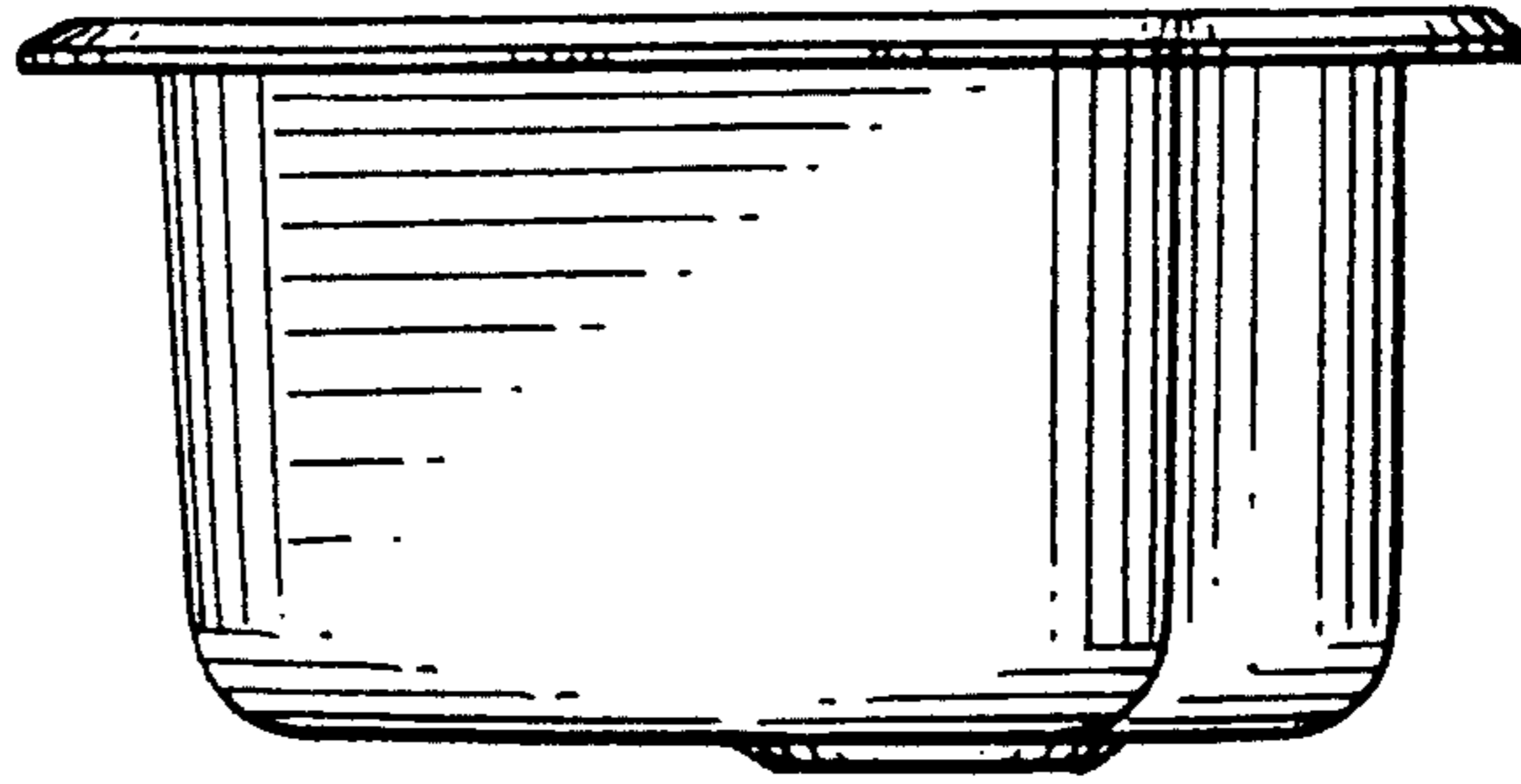

FIG.6

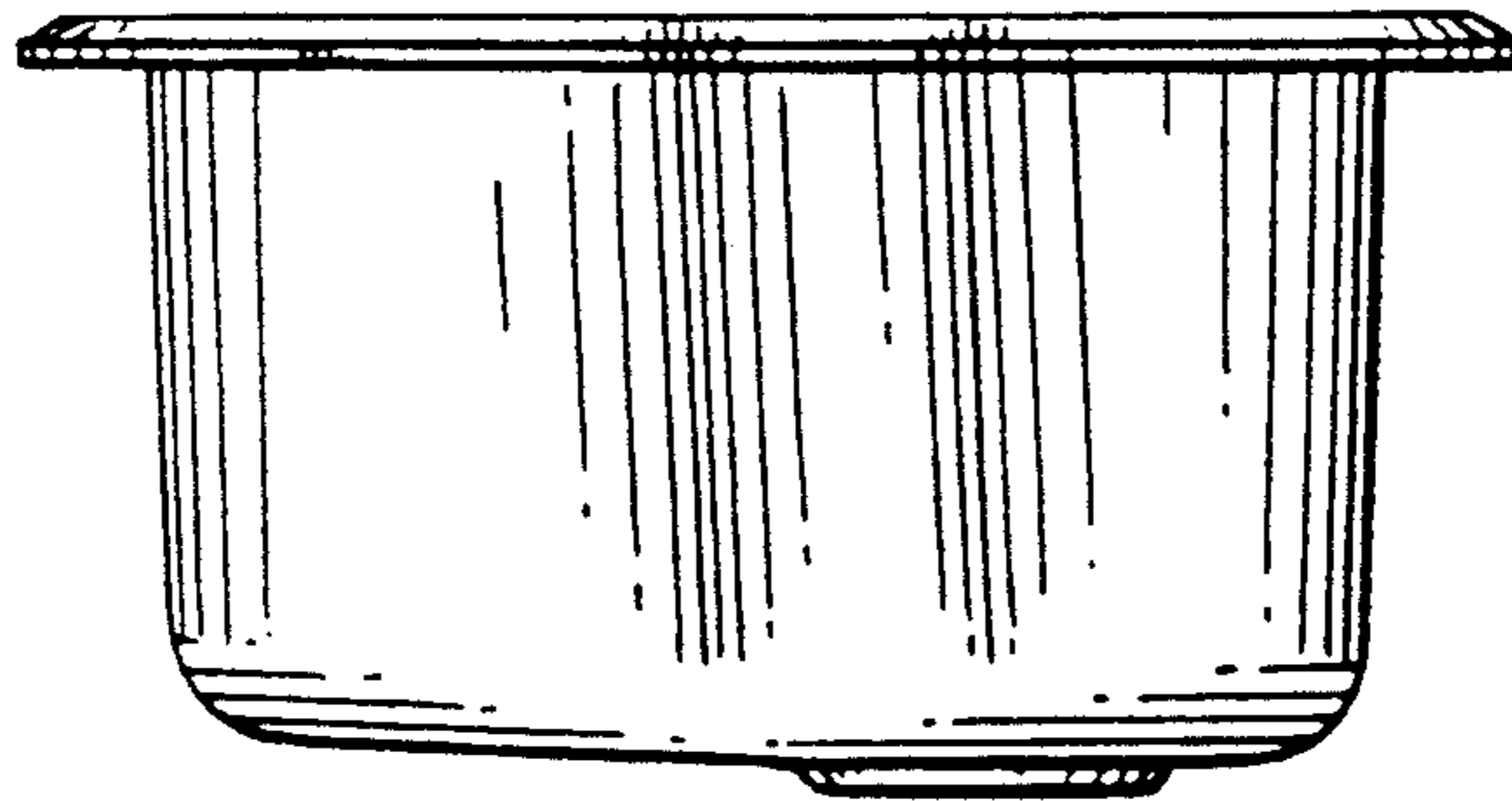

FIG.7

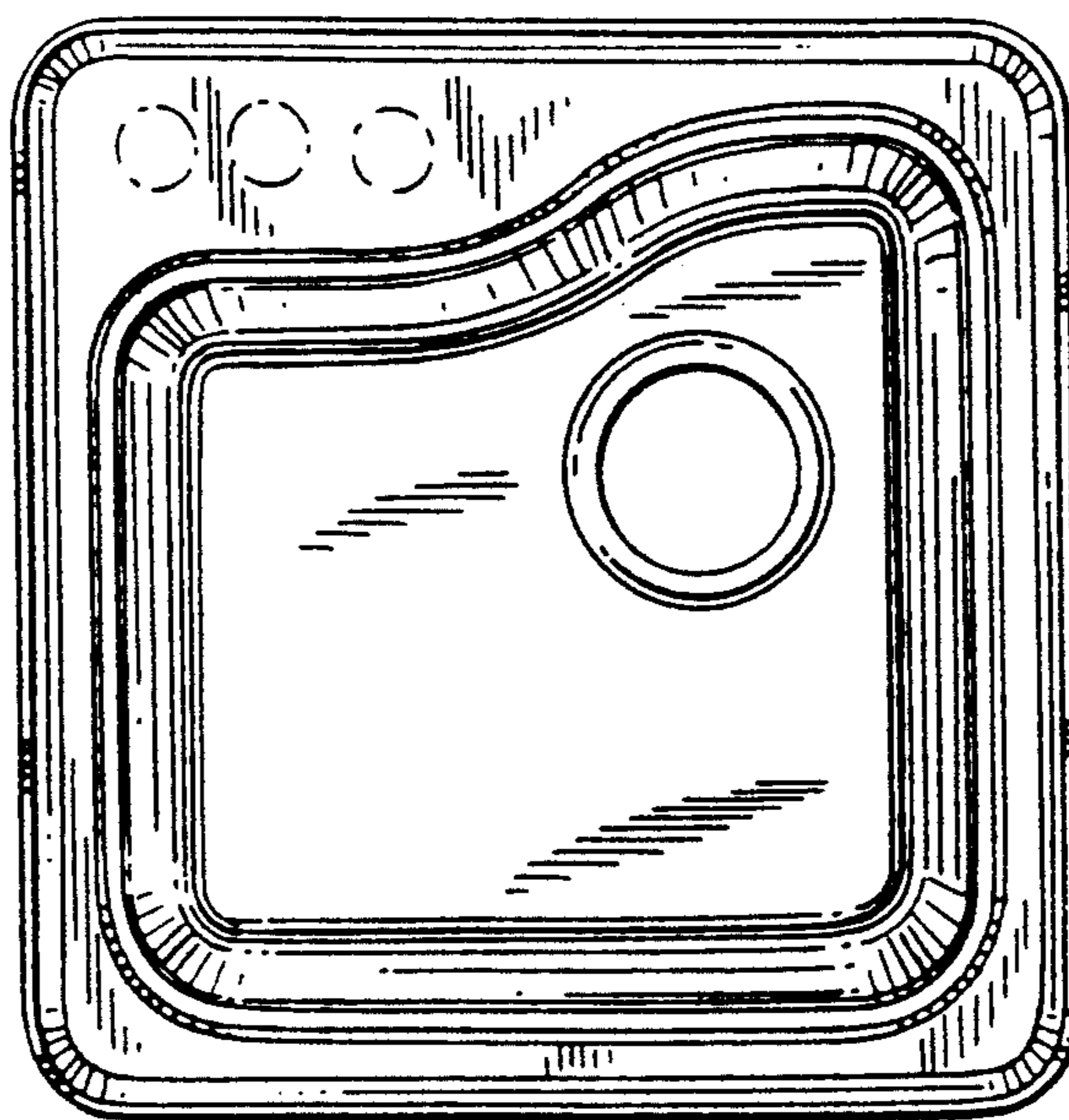

FIG.9

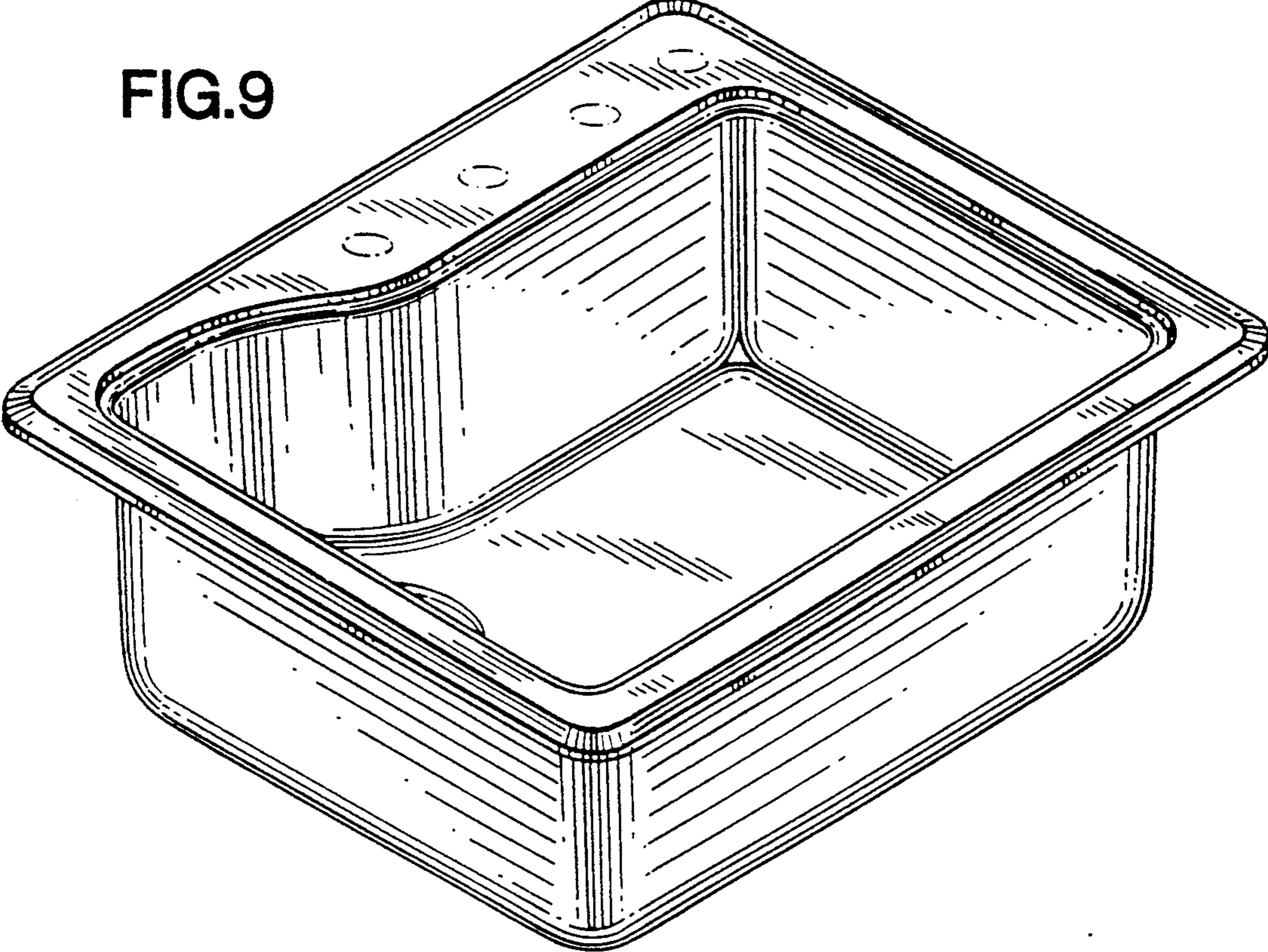

FIG.16

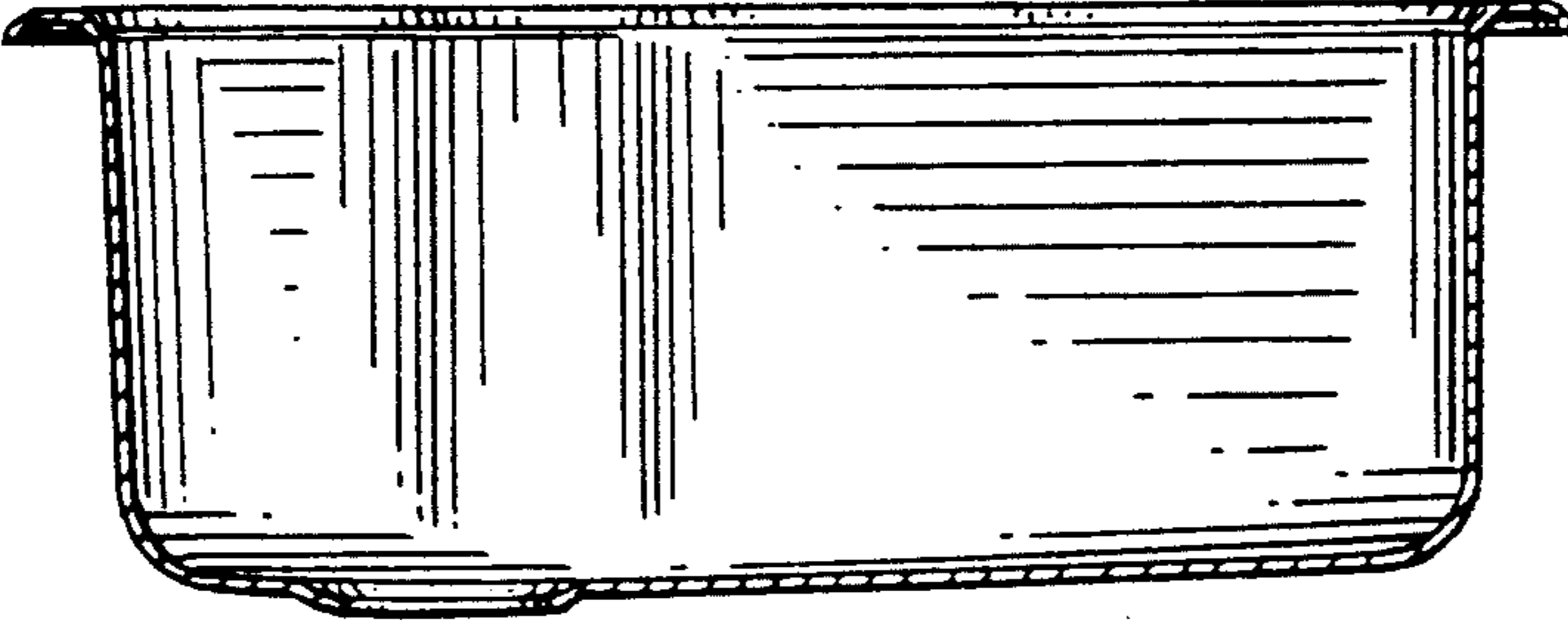

FIG. 10

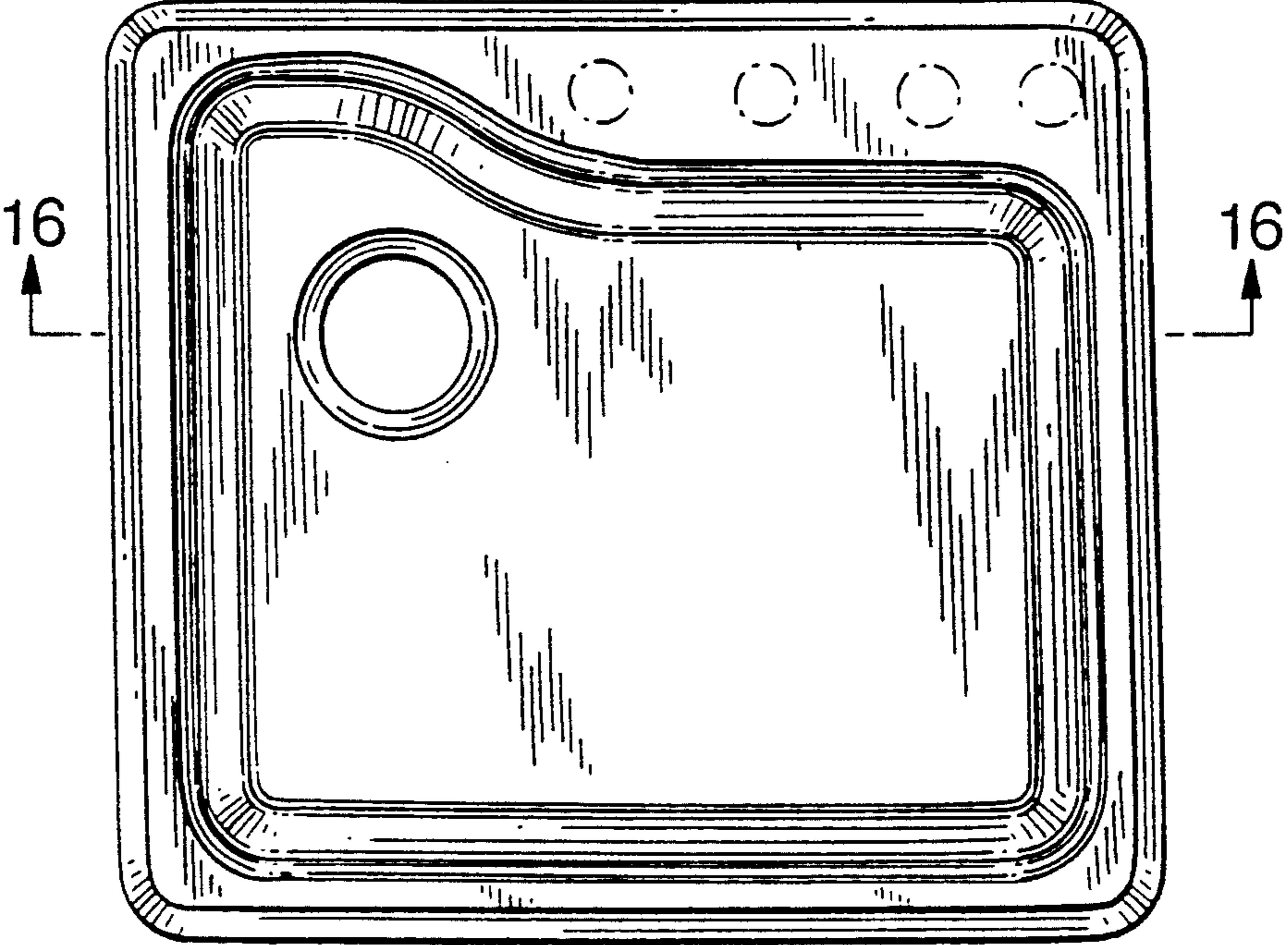

FIG. 11

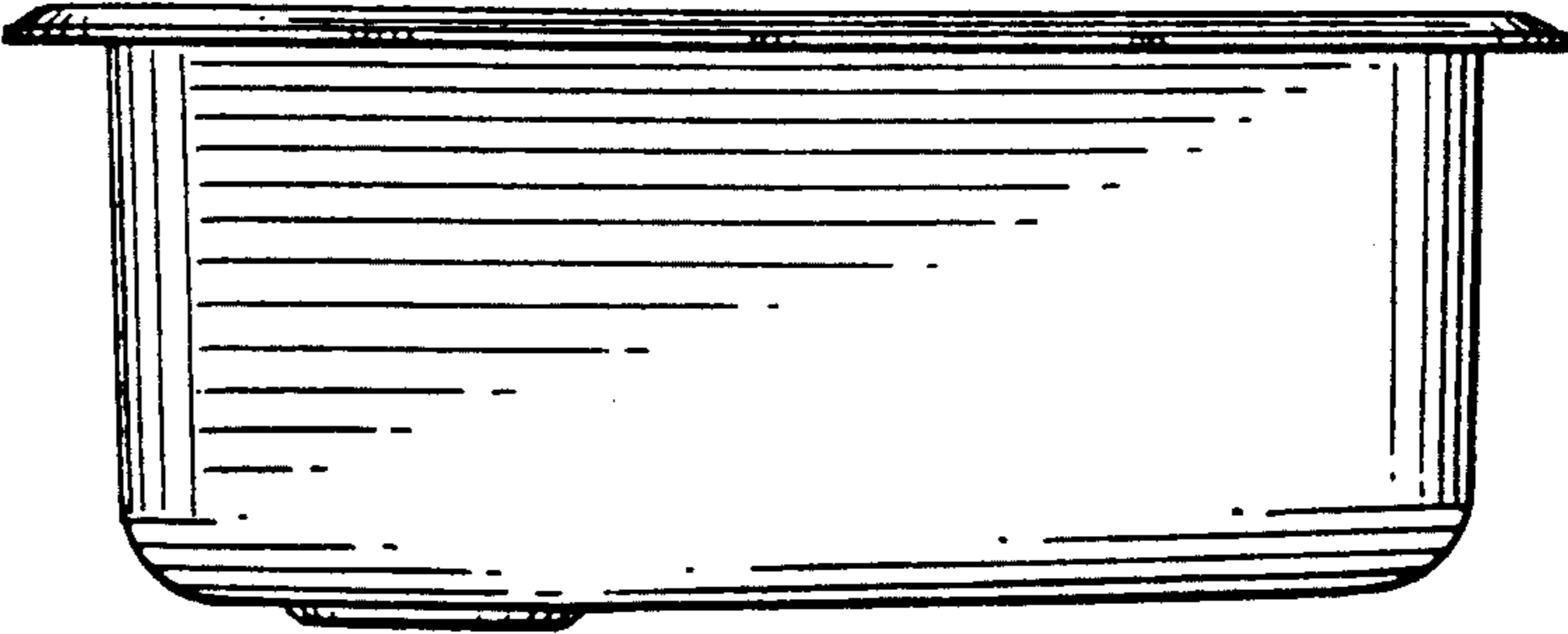

FIG. 12

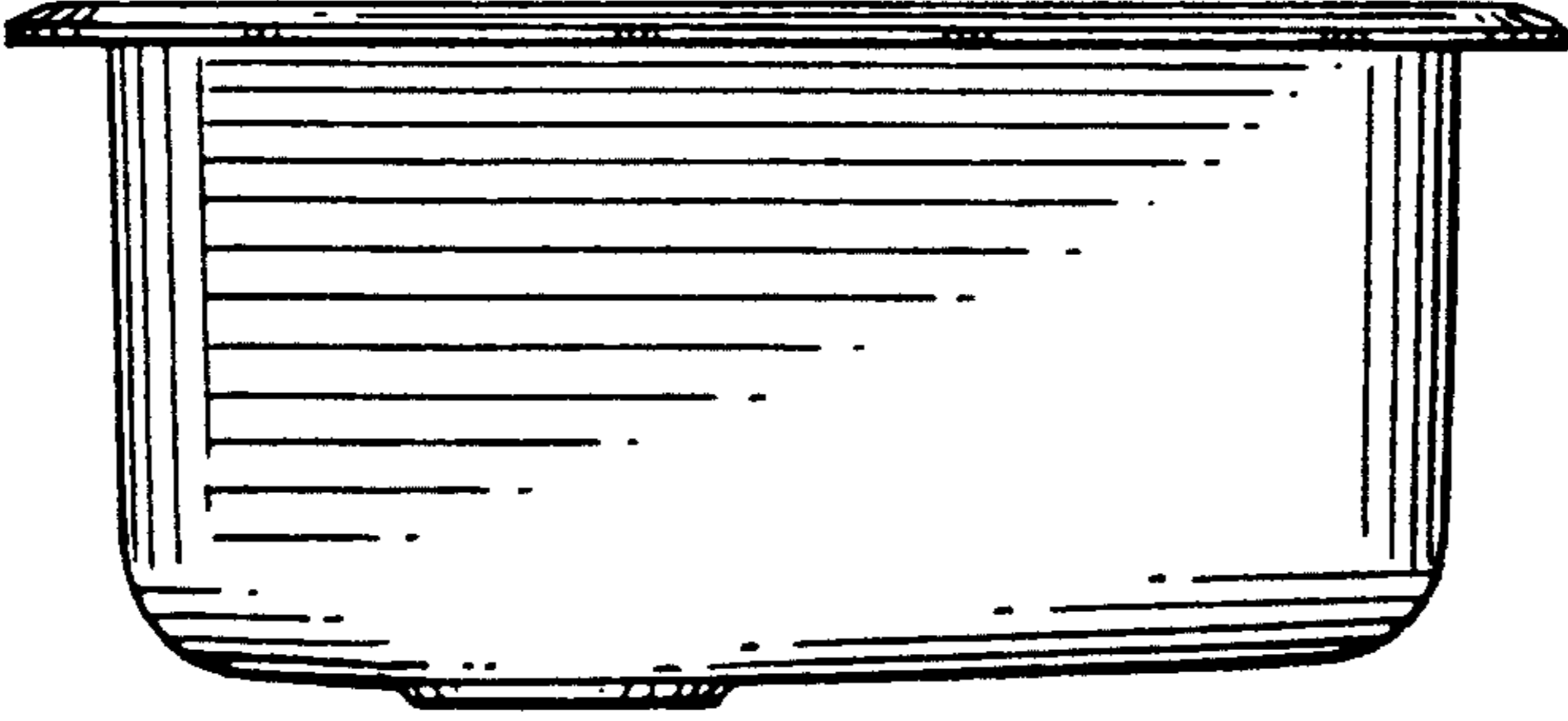

FIG. 13

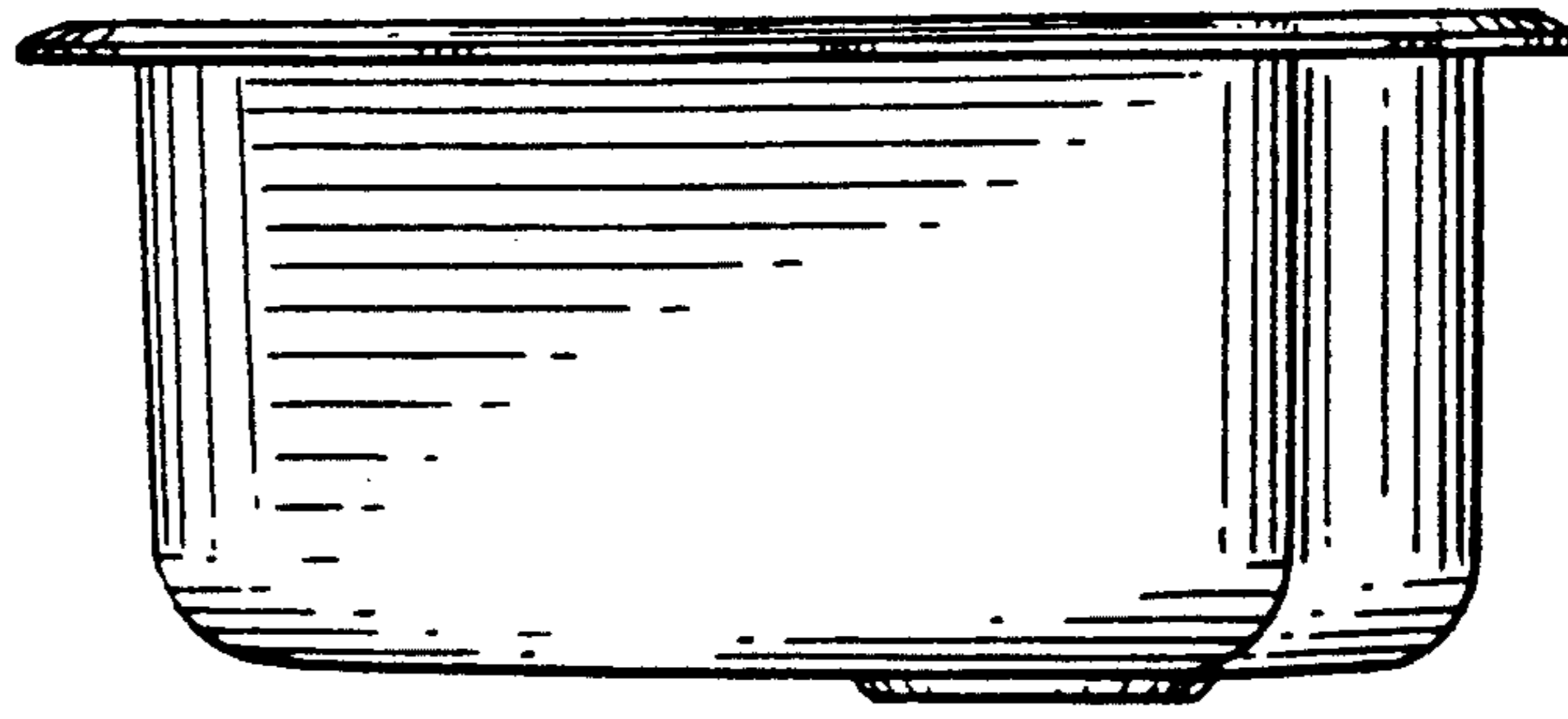

FIG. 14

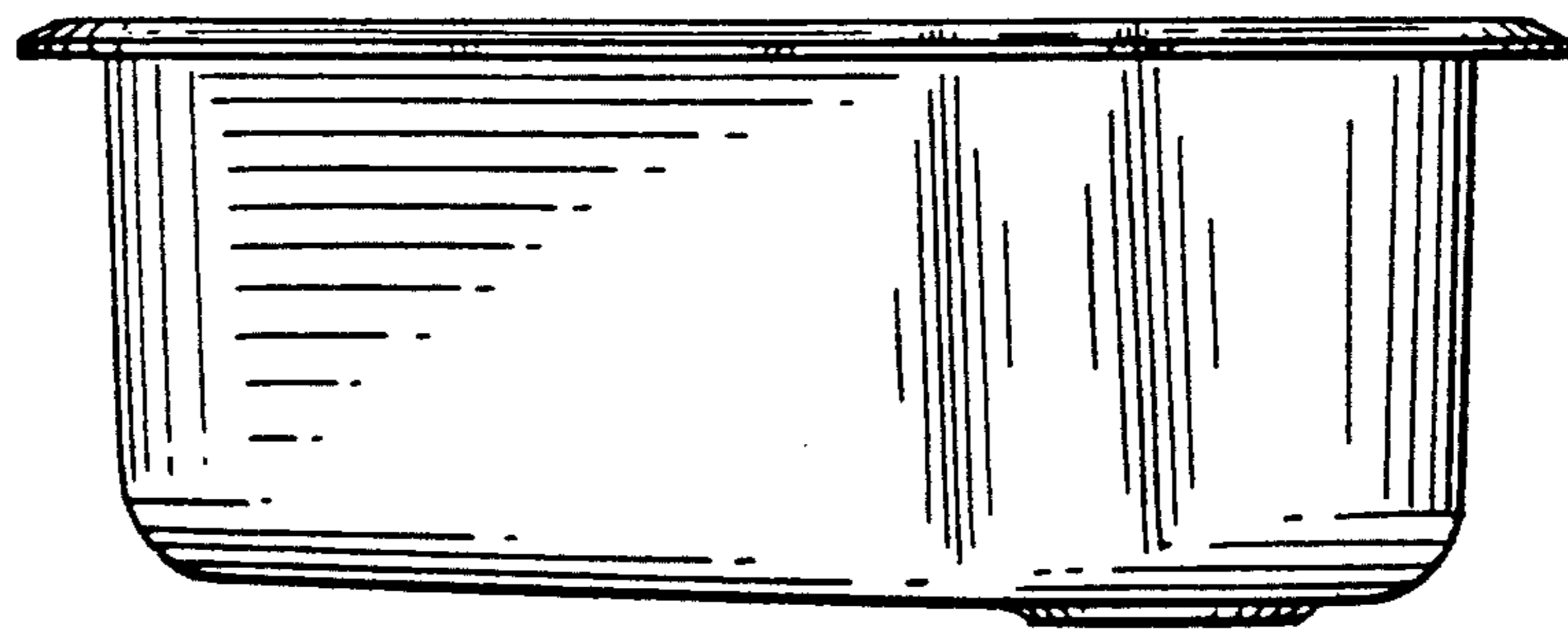

FIG. 15

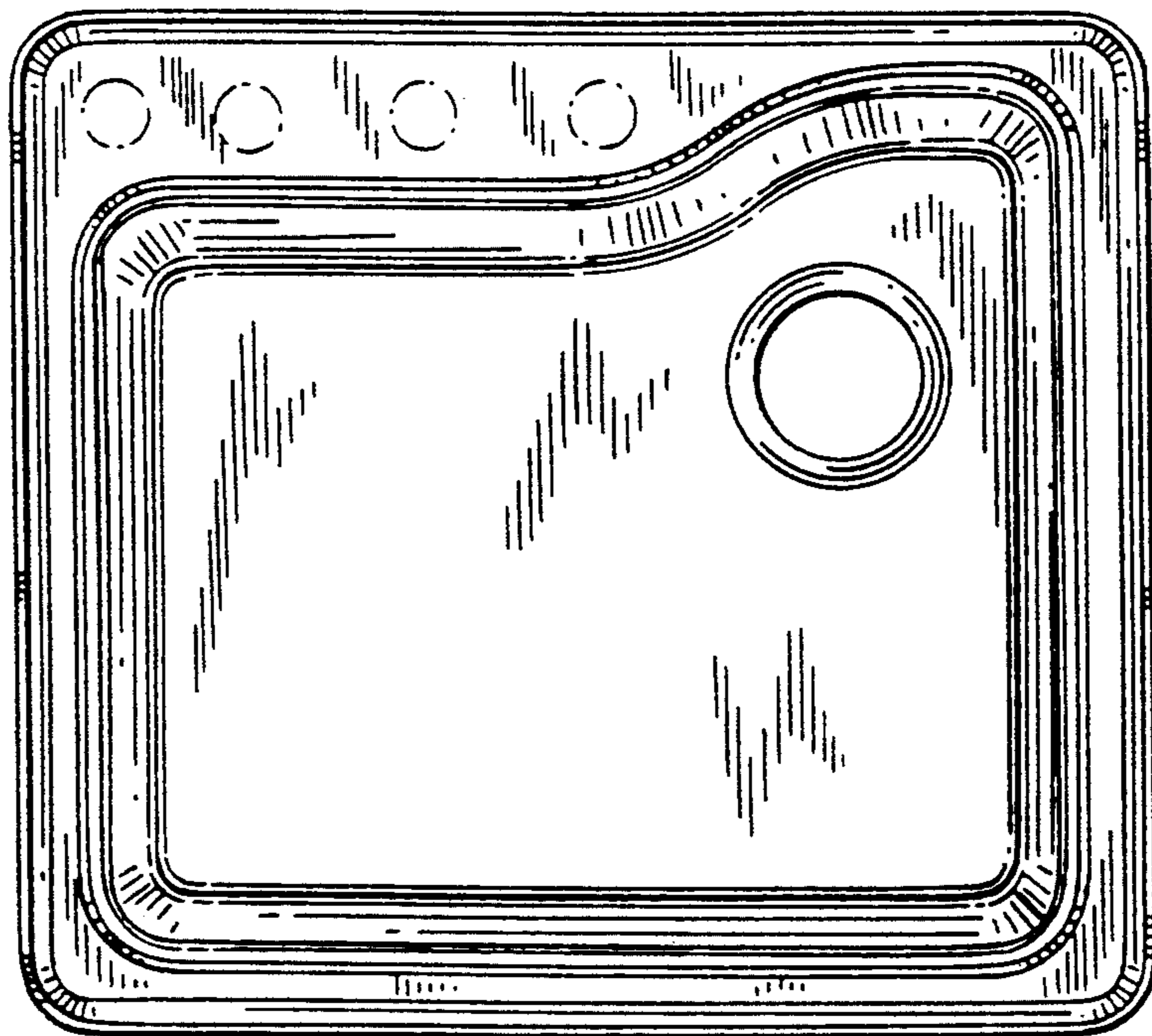

FIG.17

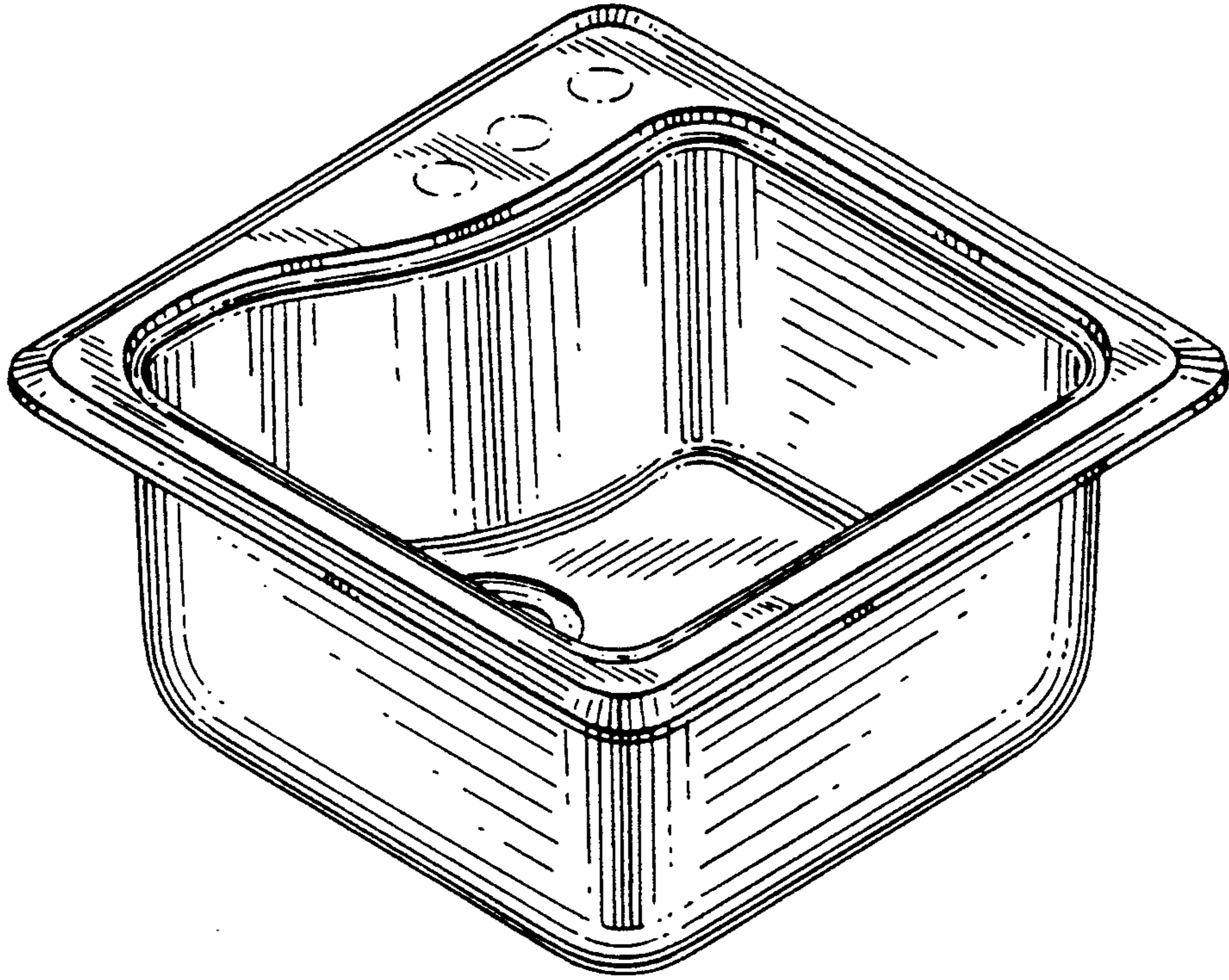

FIG.24

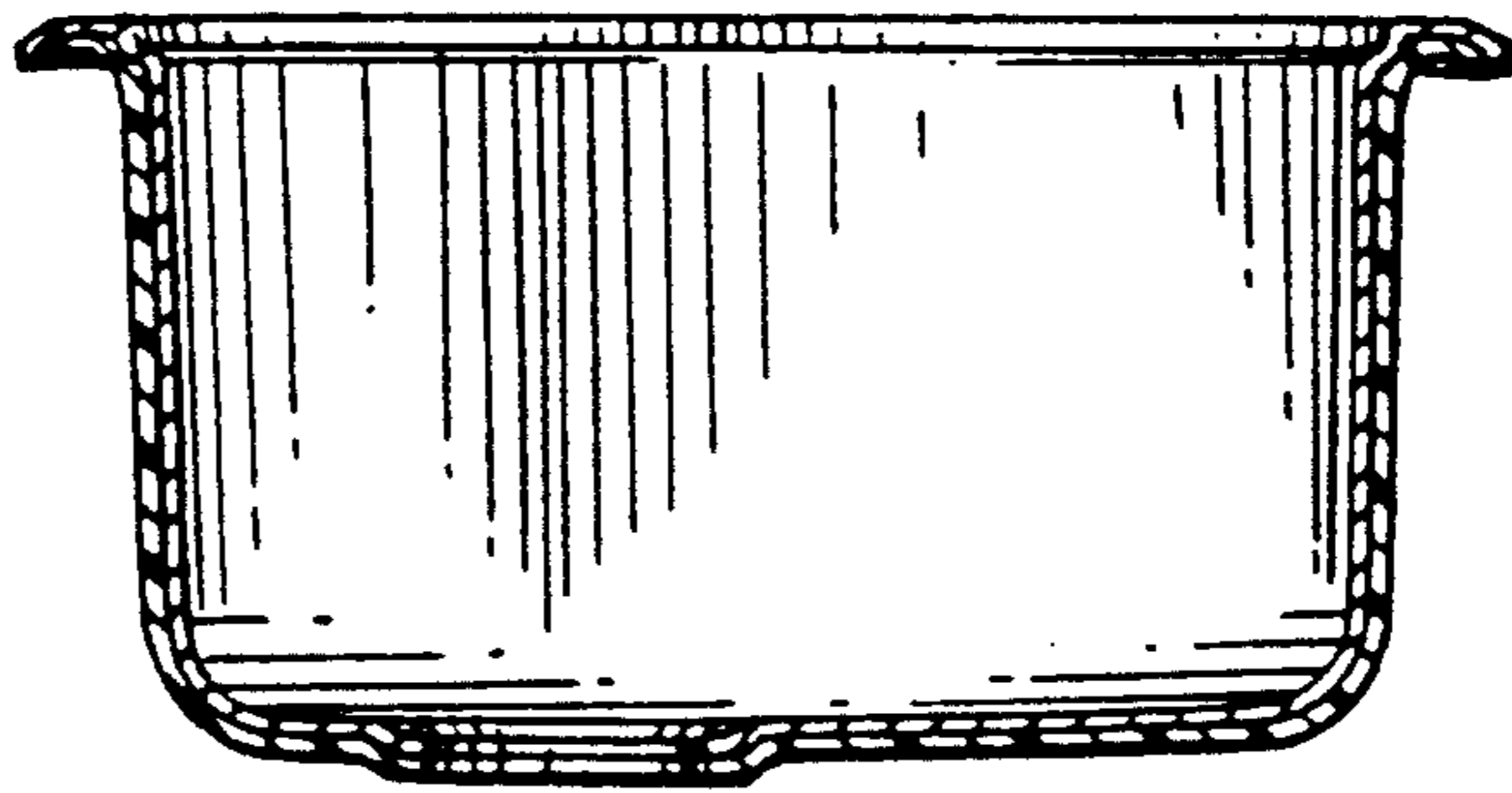



FIG. 18

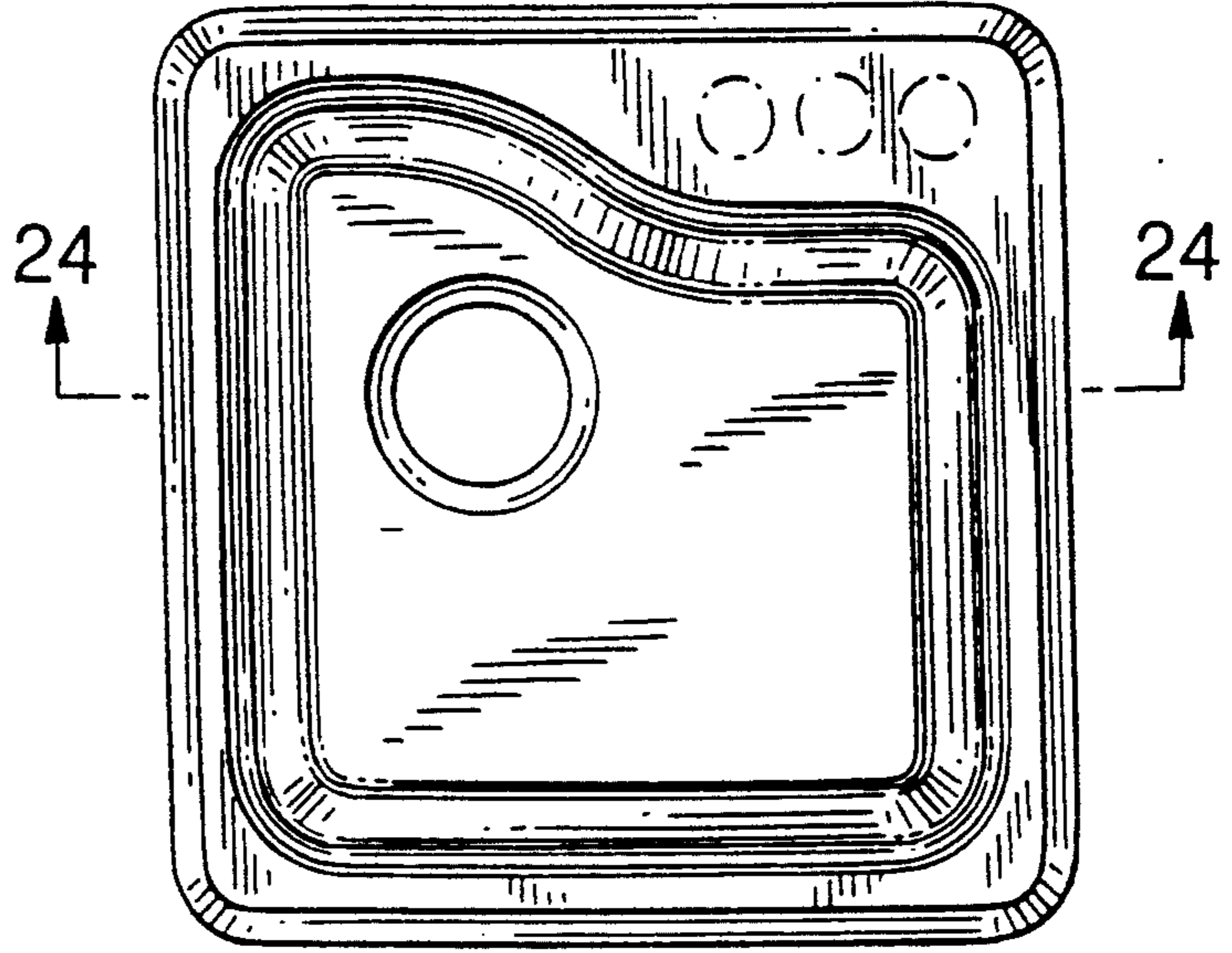

FIG. 19

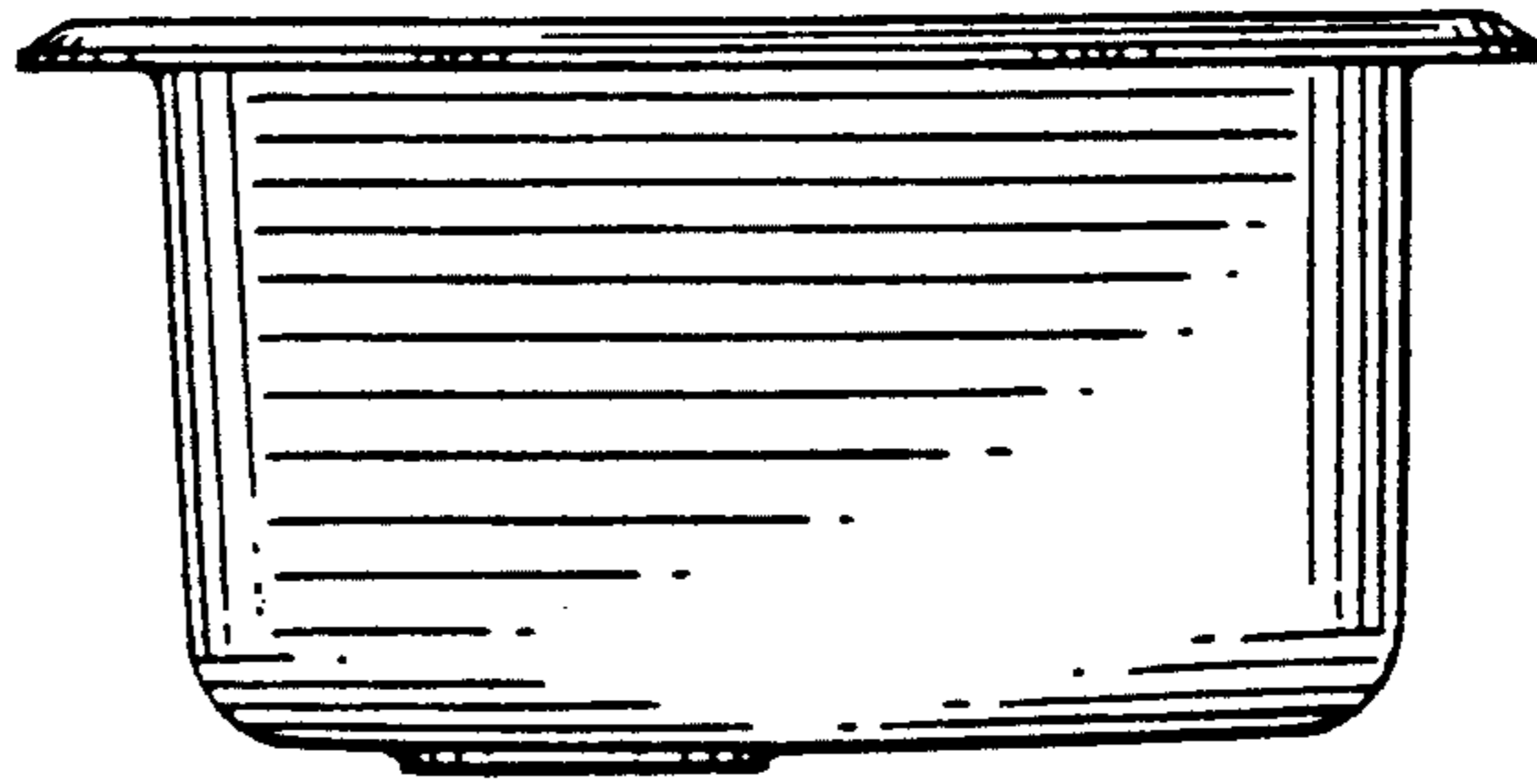

FIG. 20

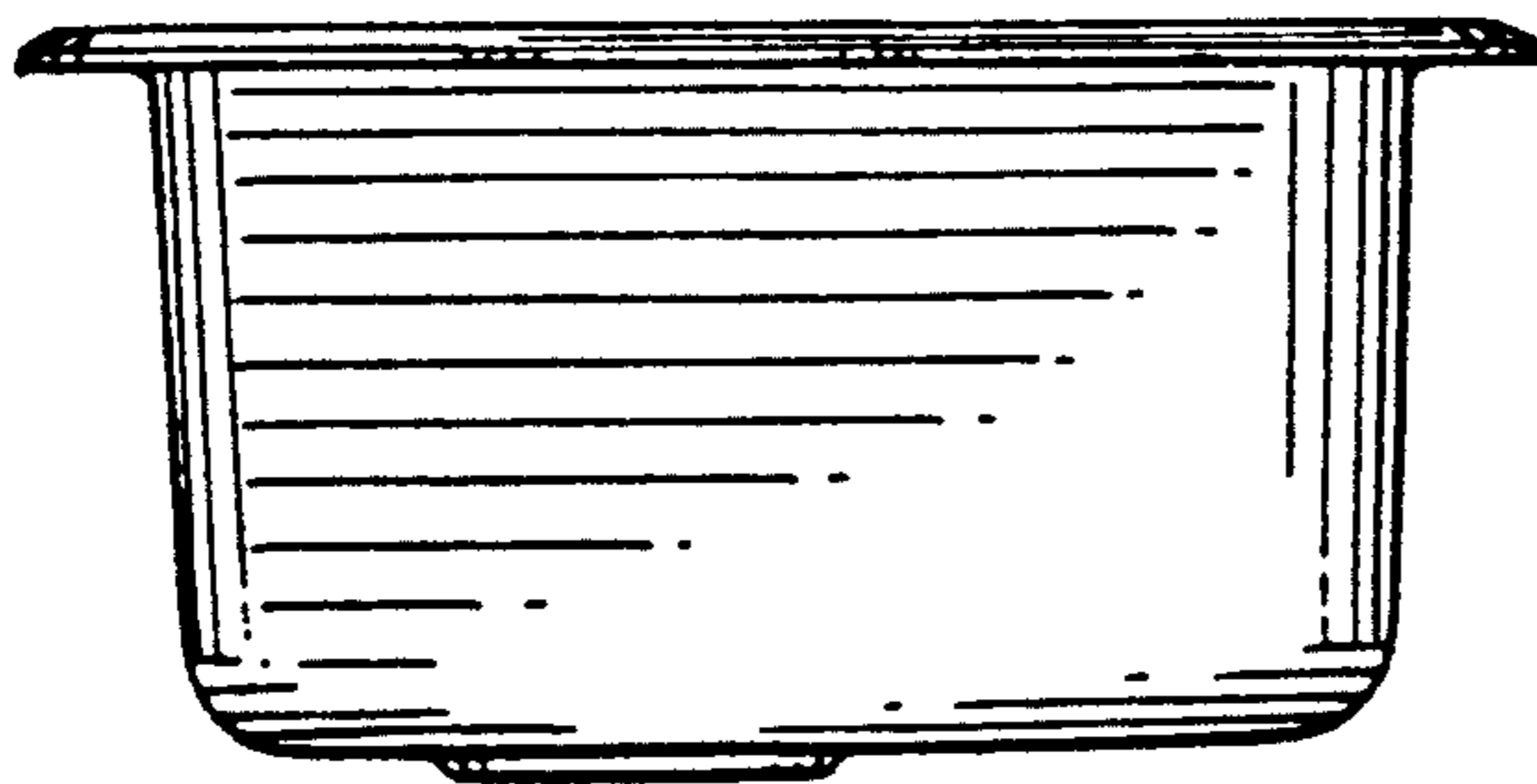

FIG.21

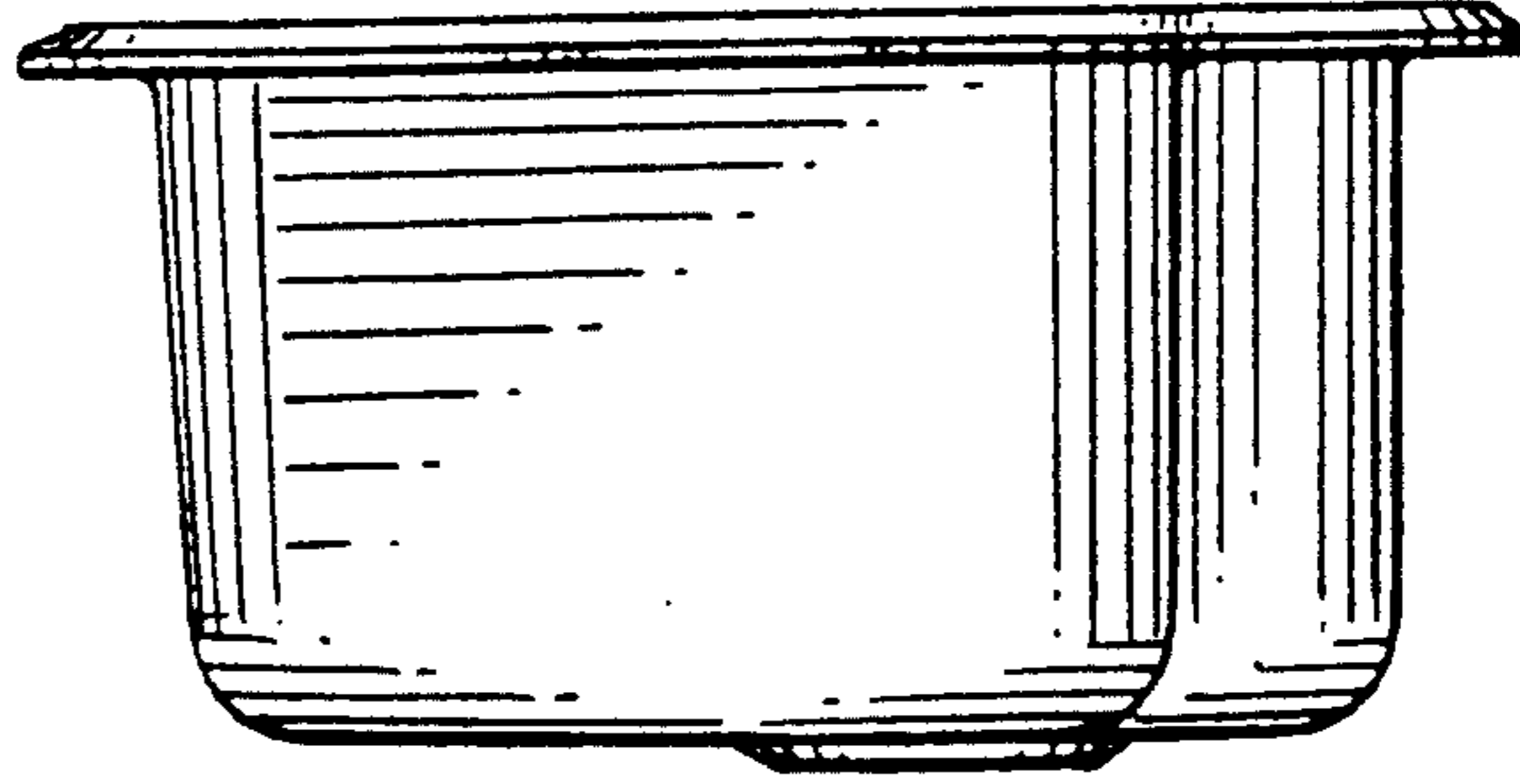

FIG.22

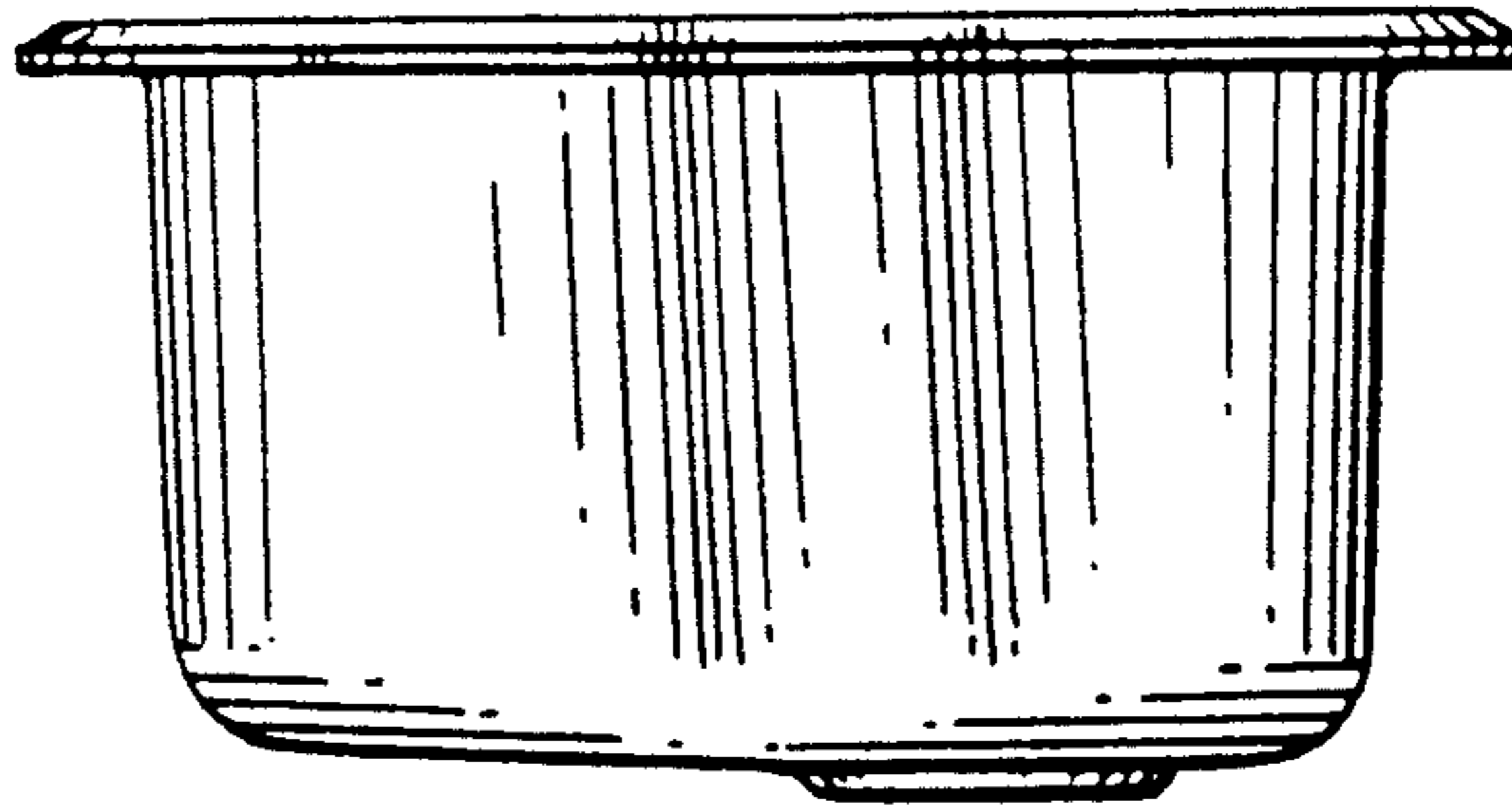

FIG.23

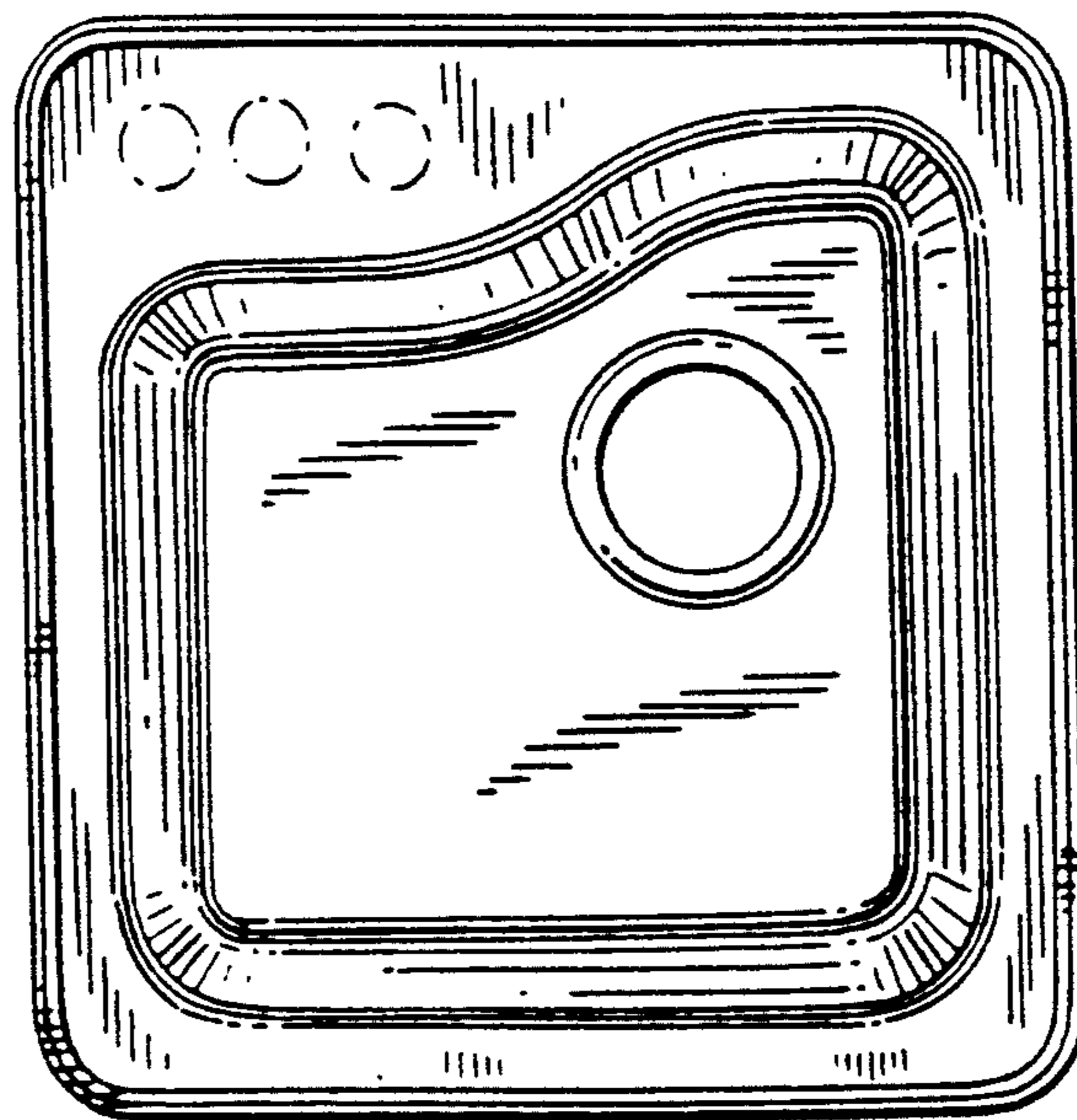

FIG.25

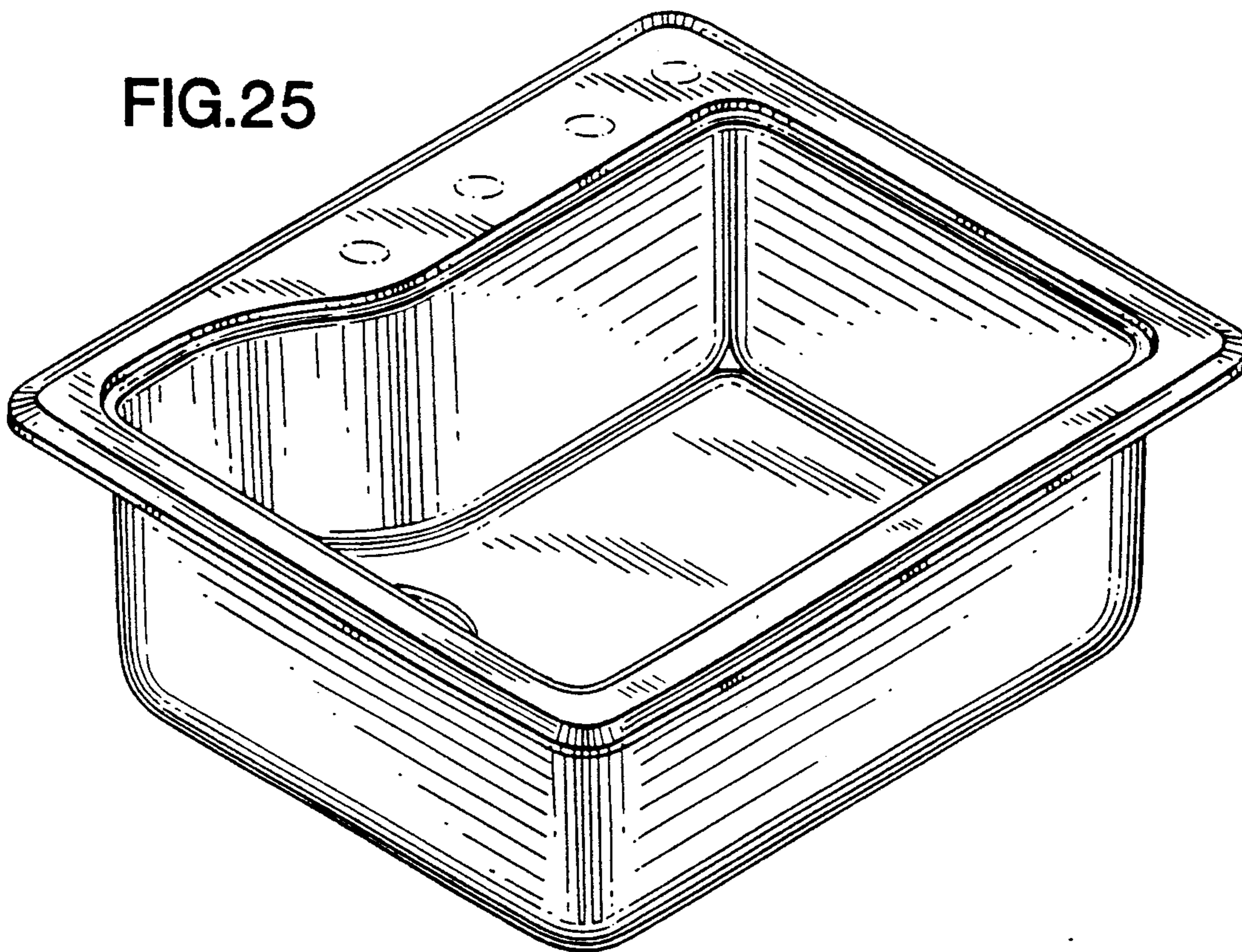

FIG.32

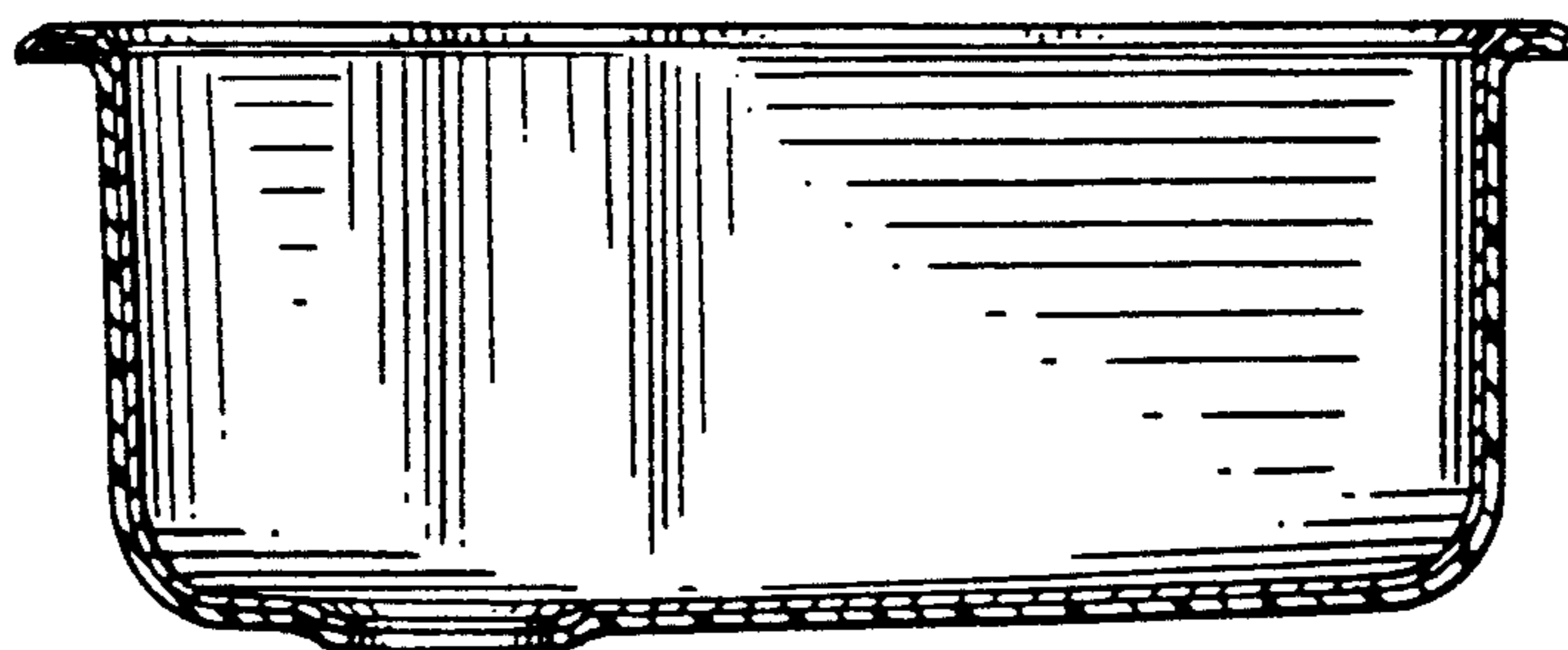

FIG.26

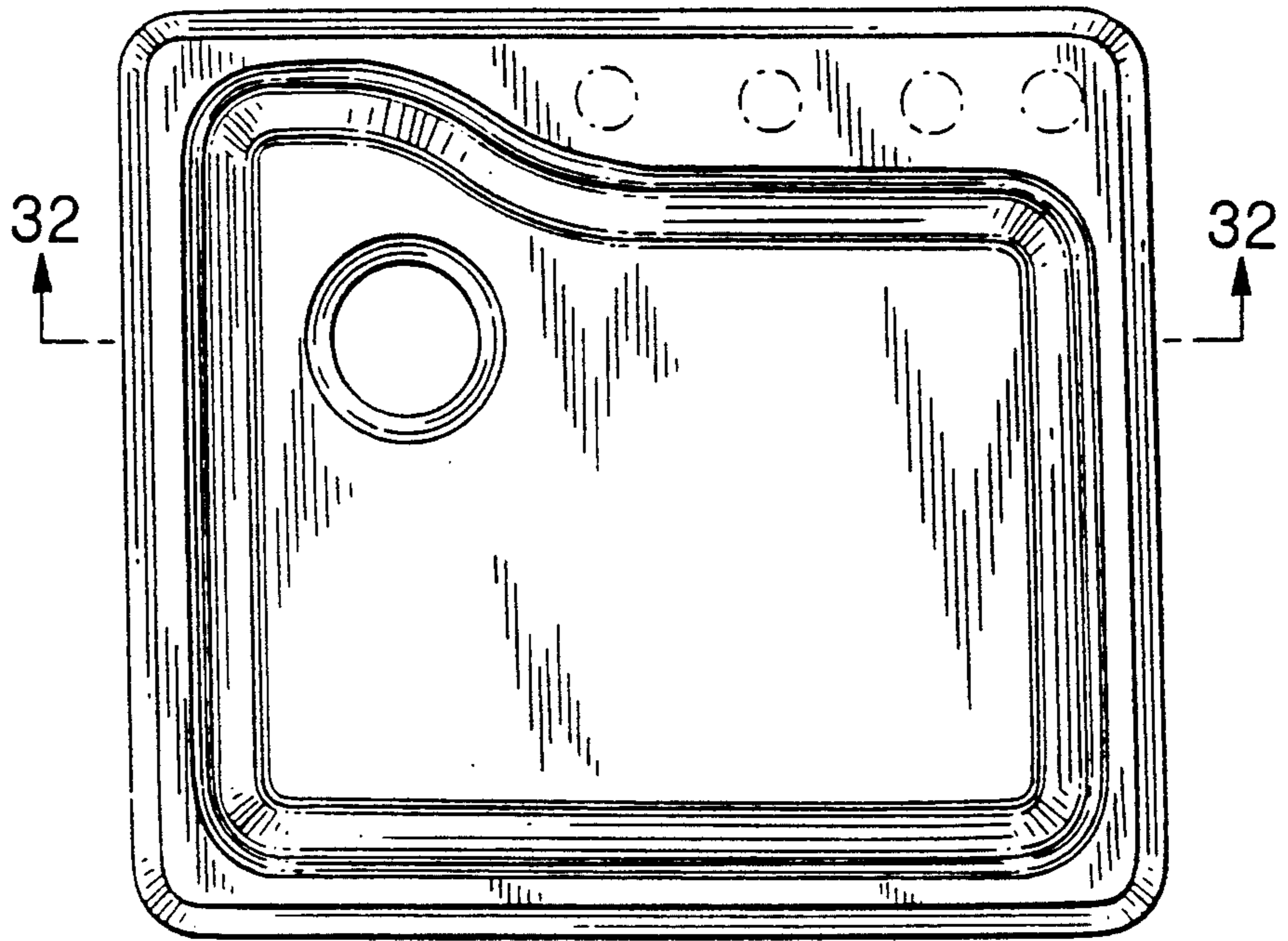

FIG.27

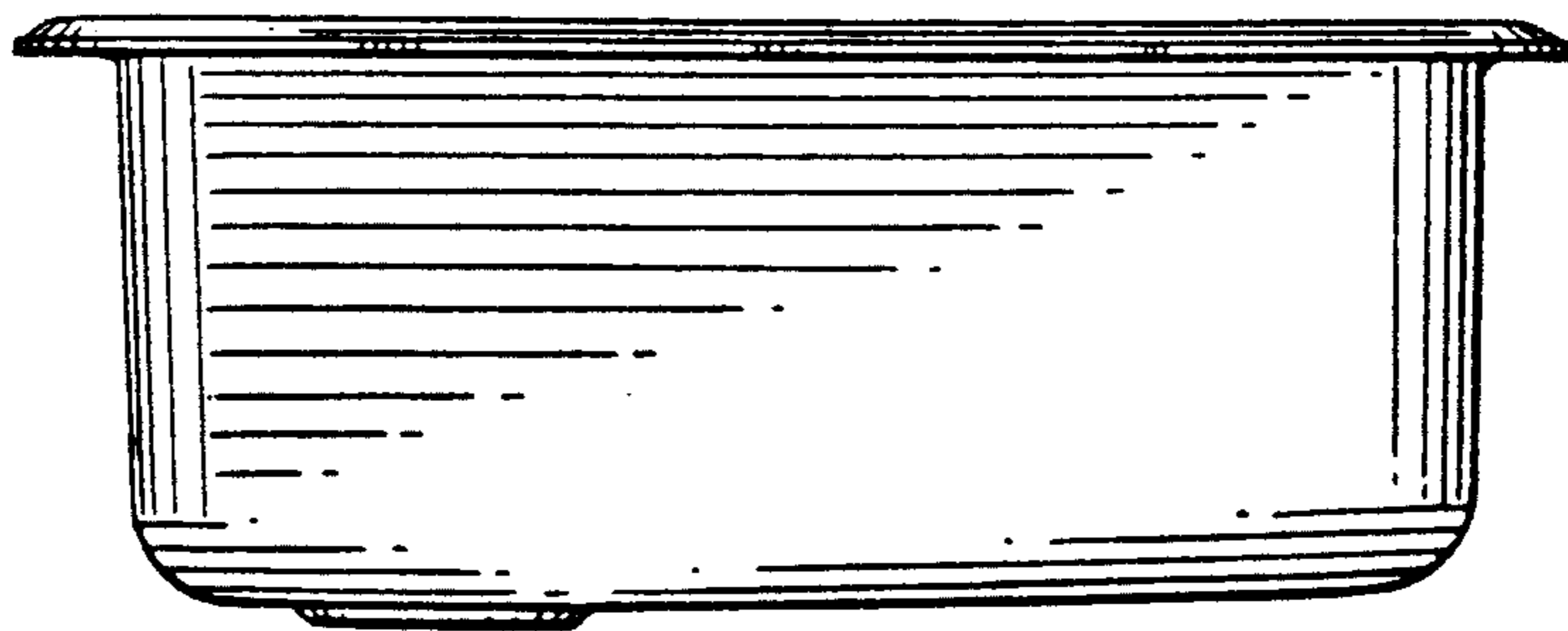

FIG.28

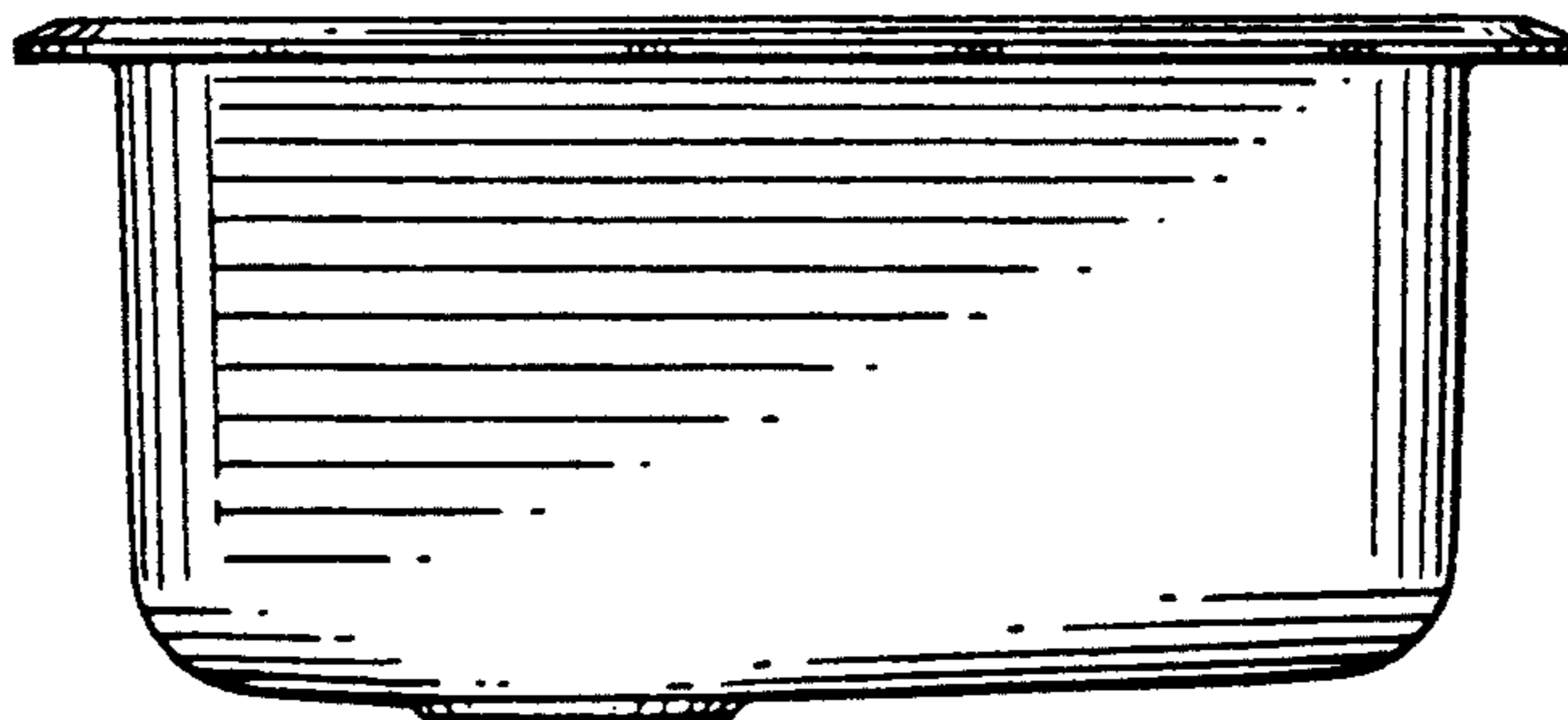

FIG.29

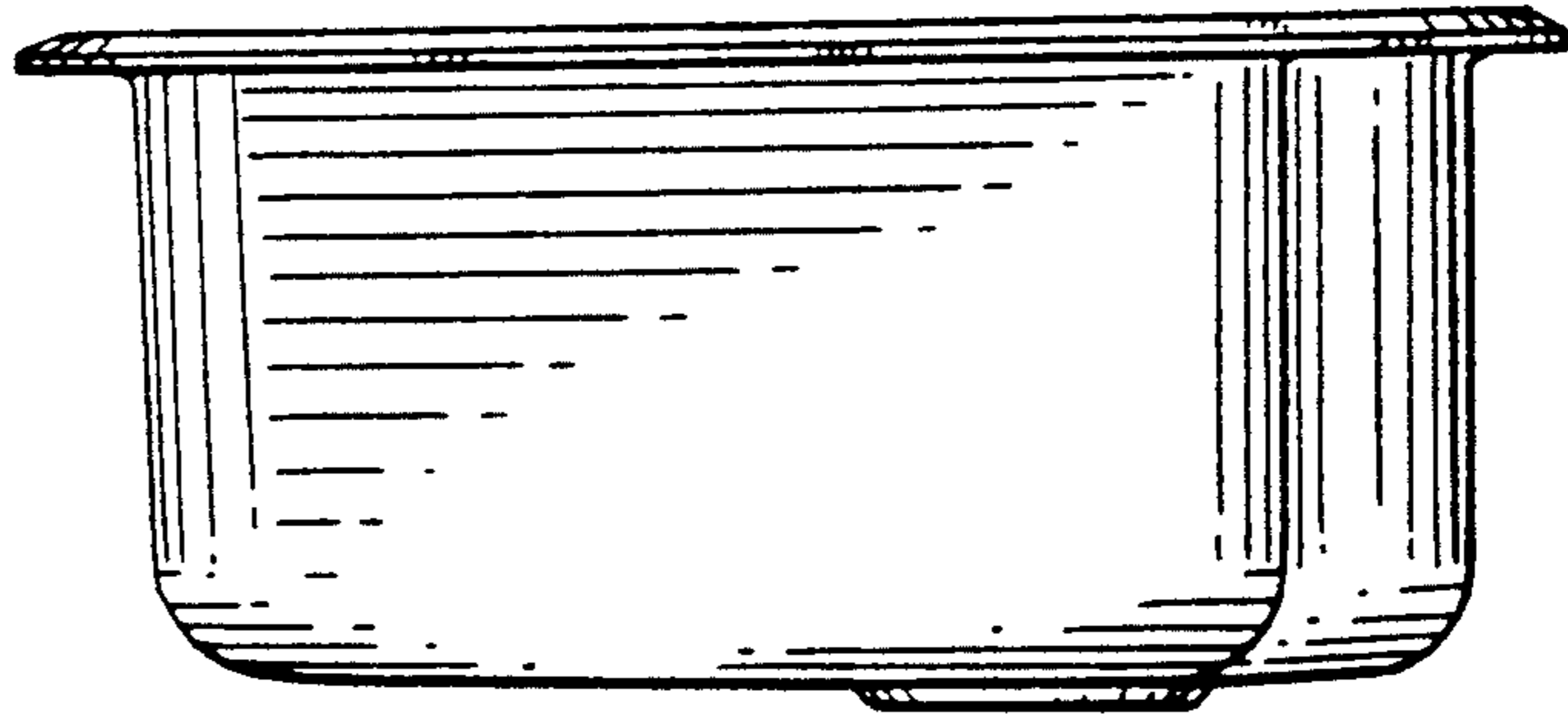

FIG.30

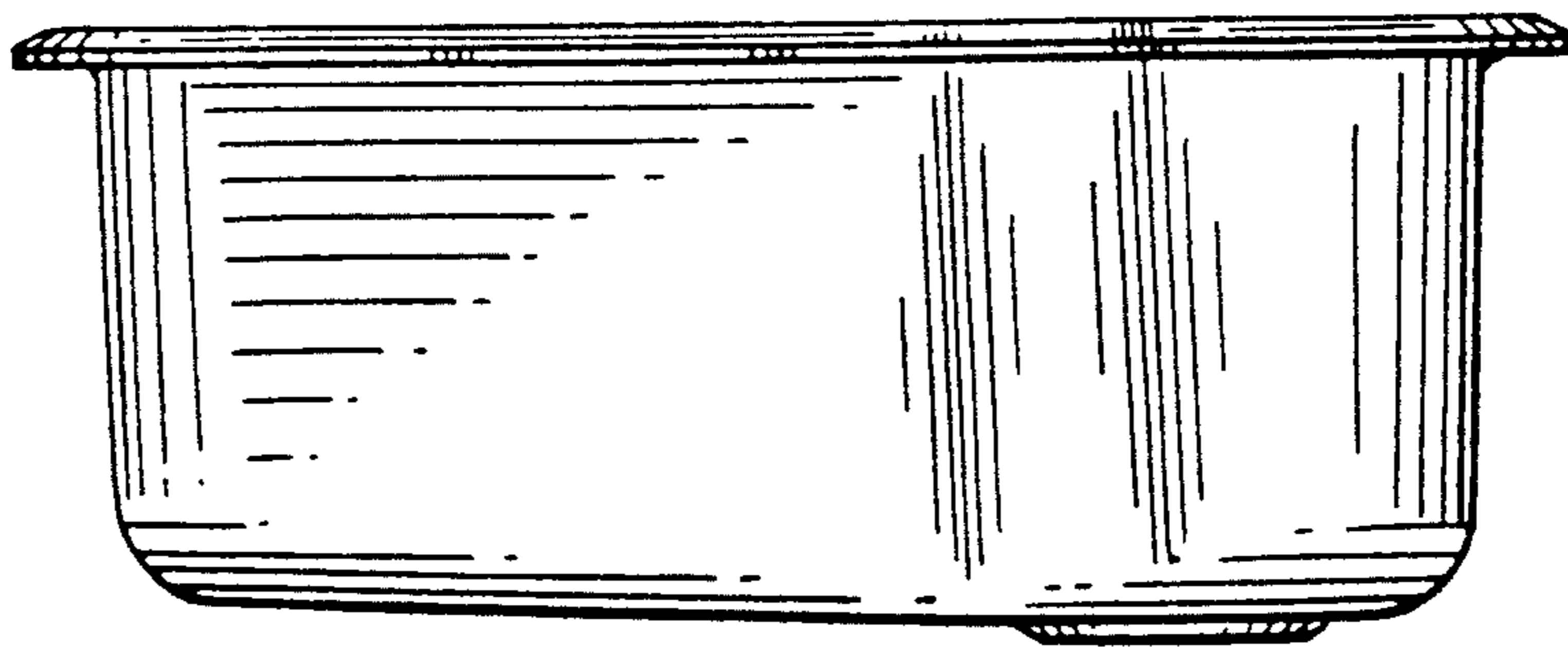

FIG.31

