



US00D345981S

United States Patent [19]

[11] Patent Number: **Des. 345,981**

Burke

[45] Date of Patent: **** Apr. 12, 1994**

[54] HEADSET

D. 333,137 2/1993 Burke D14/206
2,025,398 12/1935 Pocock et al. D14/206

[75] Inventor: **Jonathan C. Burke**, Larkspur, Calif.

[73] Assignee: **Telex Communications, Inc.**,
Minneapolis, Minn.

[**] Term: **14 Years**

[21] Appl. No.: **903,620**

[22] Filed: **Jun. 24, 1992**

[52] U.S. Cl. **D14/206**

[58] Field of Search 181/129, 136, 137;
379/430, 444; 381/25, 68, 158, 183, 187;
D14/205, 206, 223

OTHER PUBLICATIONS

Stereo Review Jan. 1989, p. 38, Azden Headset.

Primary Examiner—Bernard Ansher

Assistant Examiner—Sandra Morris

Attorney, Agent, or Firm—Fredrikson & Byron

[57] CLAIM

The ornamental design for a headset, as shown.

DESCRIPTION

FIG. 1 is a reduced perspective of a headset showing my new design;

FIG. 2 is a front elevational view thereof;

FIG. 3 is a rear elevational view thereof;

FIG. 4 is a left side elevational view thereof;

FIG. 5 is a right side elevational view thereof;

FIG. 6 is a top view thereof; and,

FIG. 7 is a bottom view thereof.

[56] References Cited

U.S. PATENT DOCUMENTS

D. 299,337 1/1989 Wiegel D14/206
D. 318,053 7/1991 Ludeke et al. D14/206
D. 327,265 6/1992 Jasey D14/205

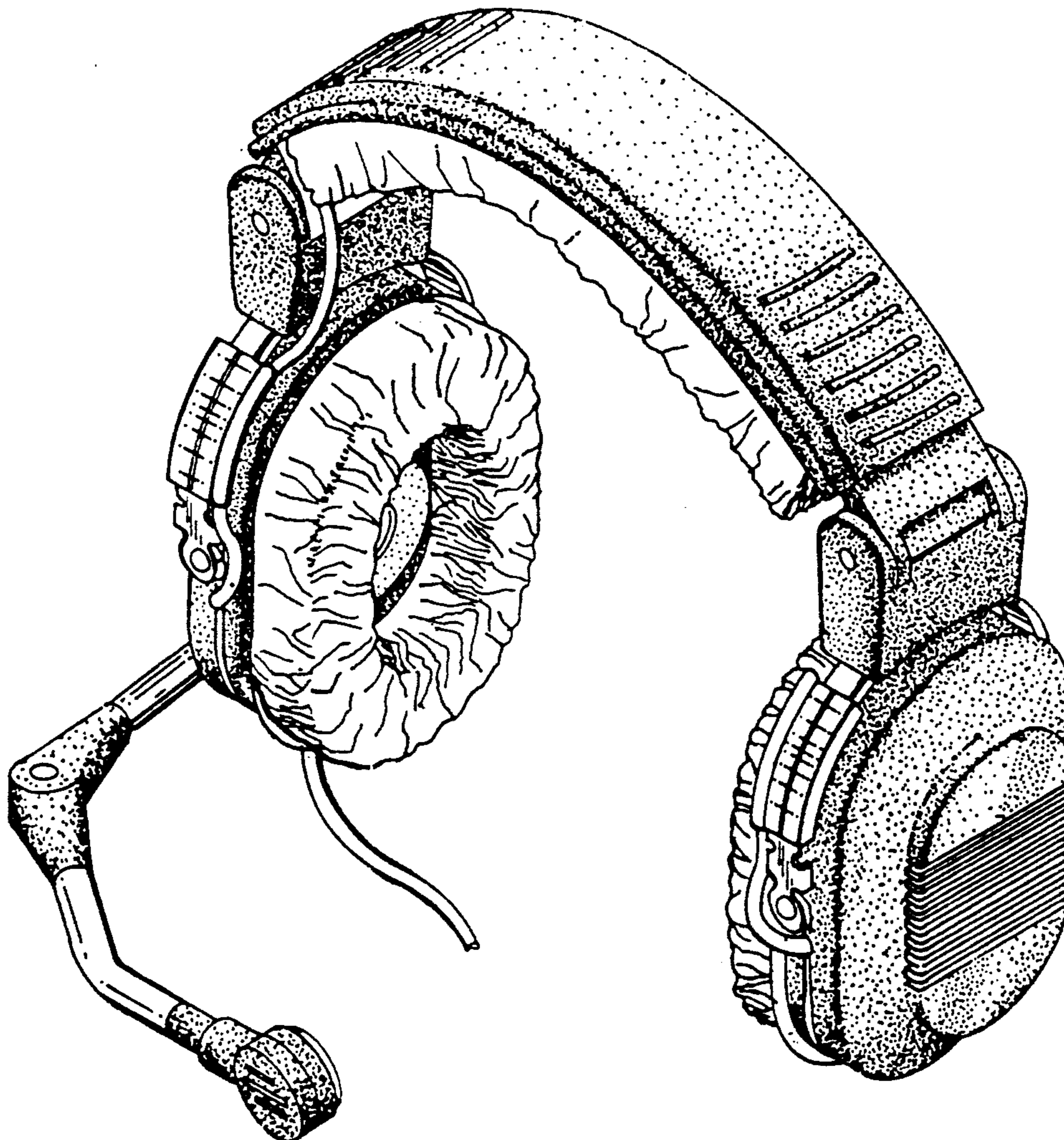

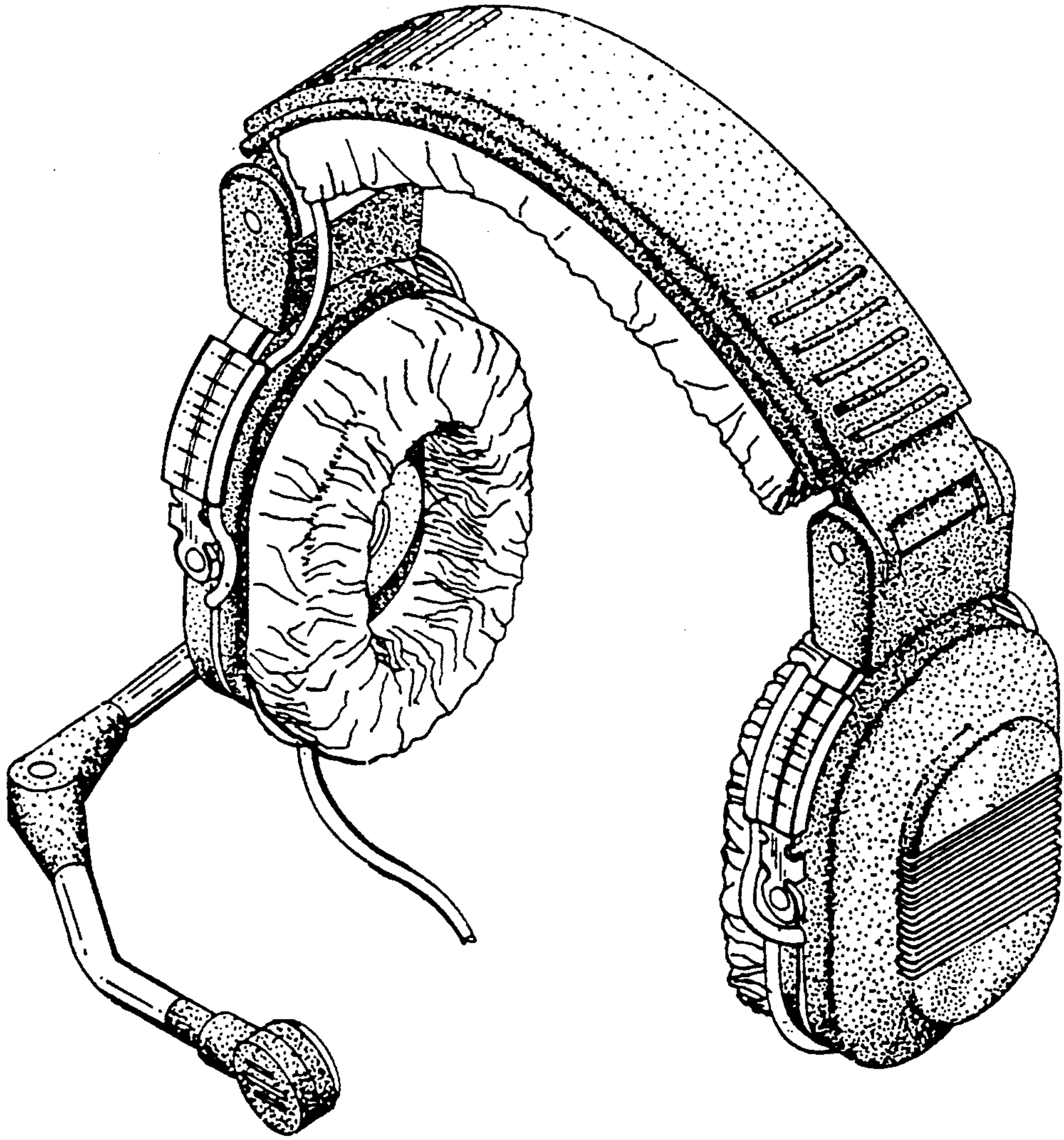

Fig. 1

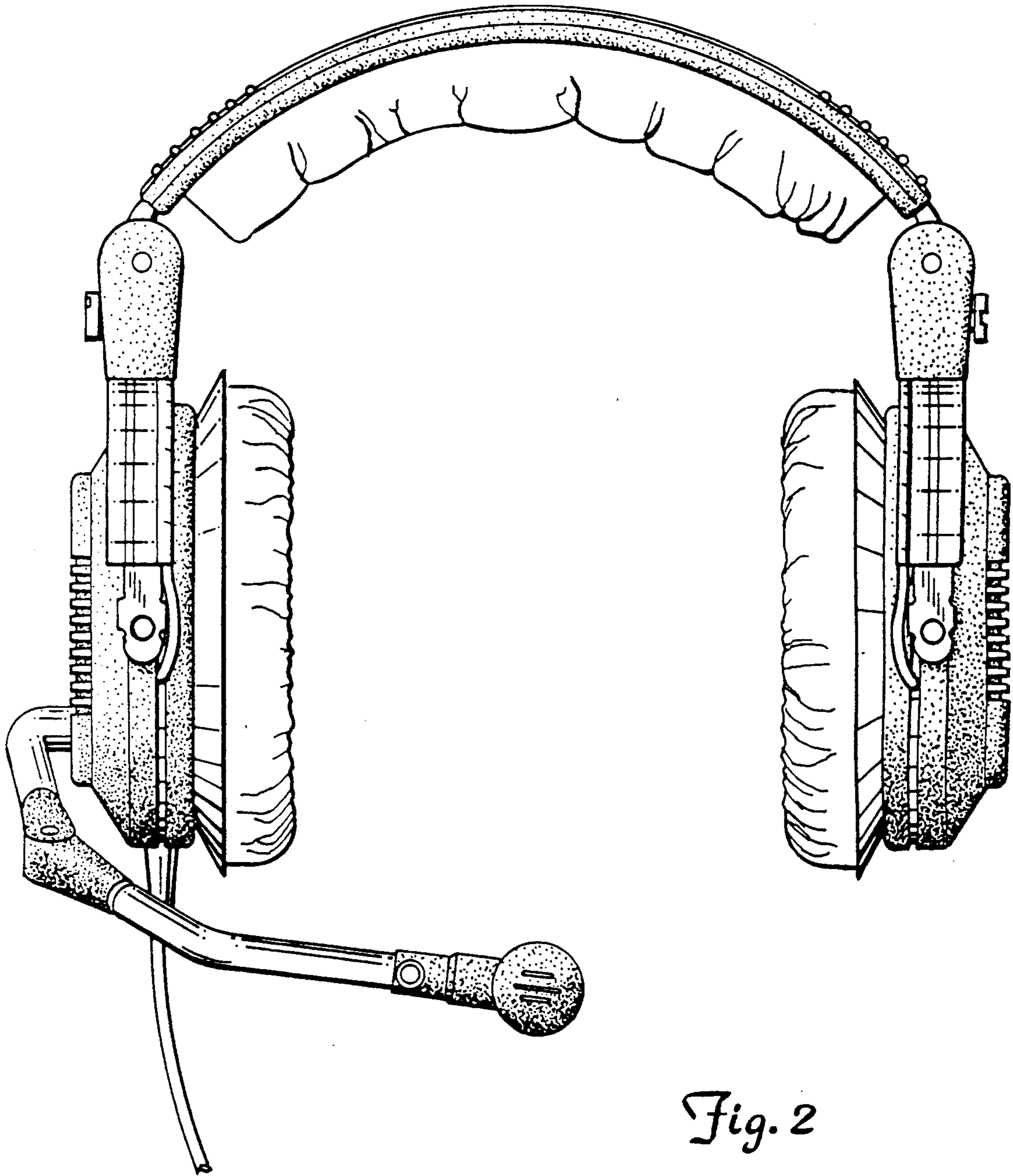

Fig. 2

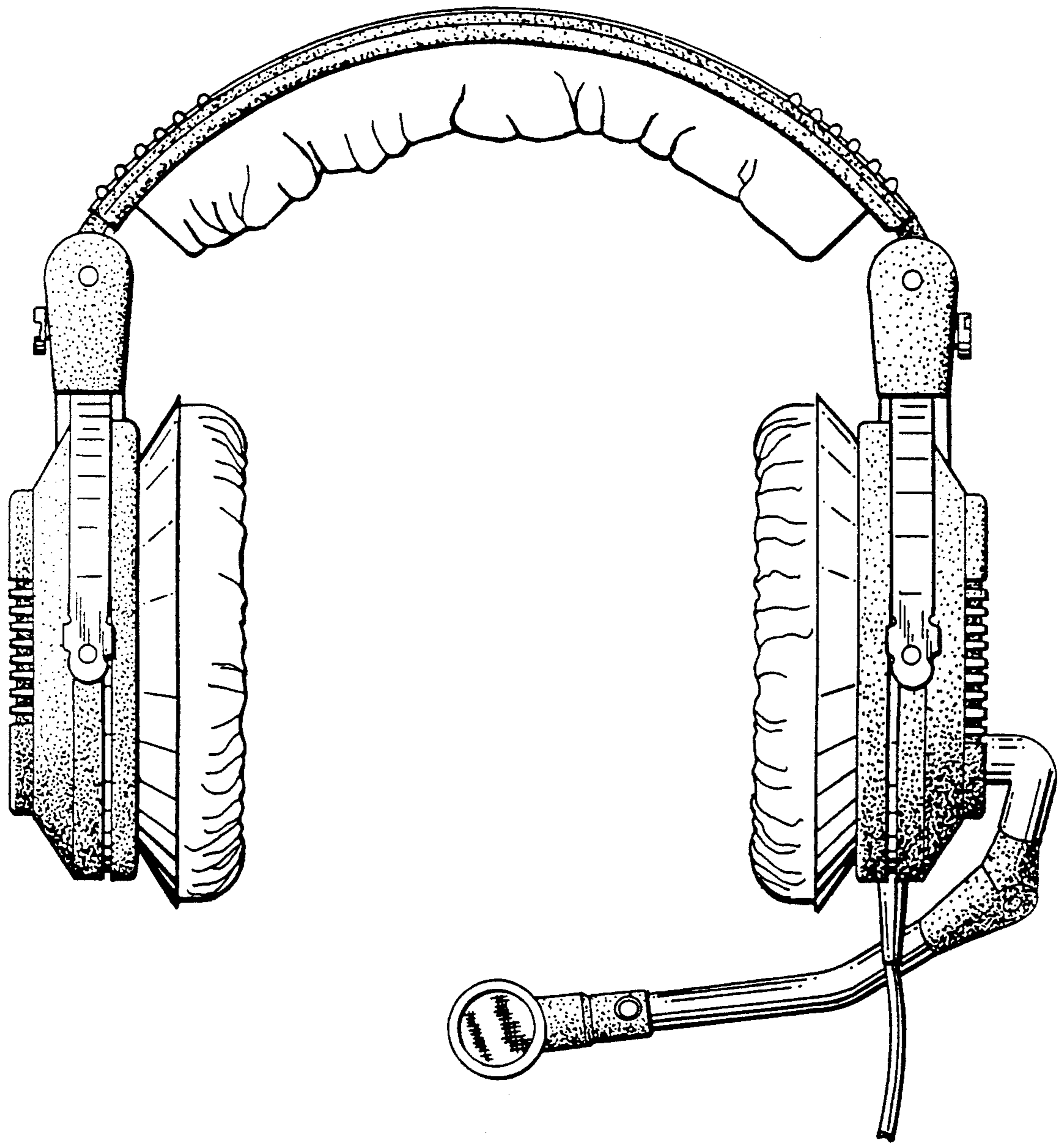

Fig. 3

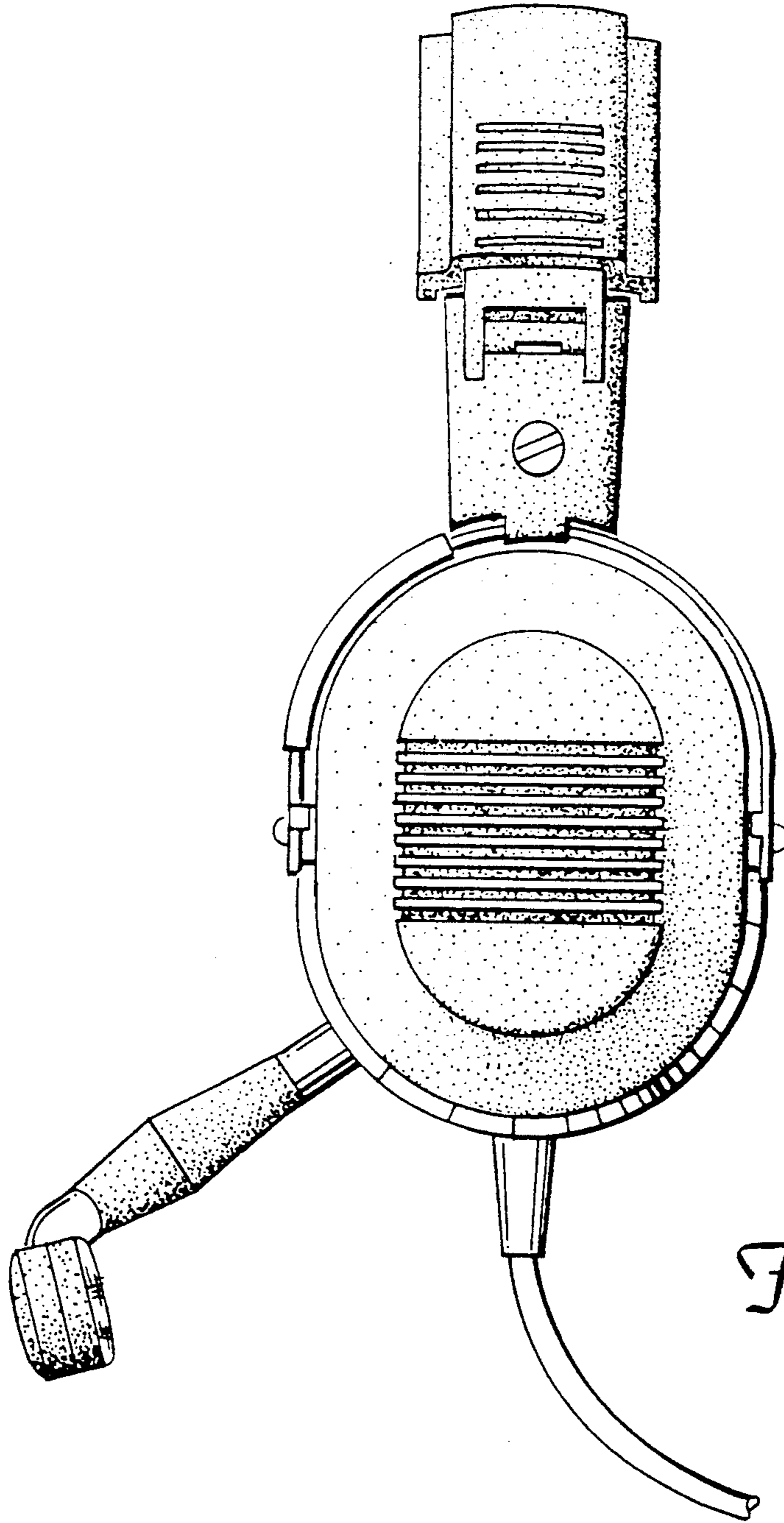

Fig. 4

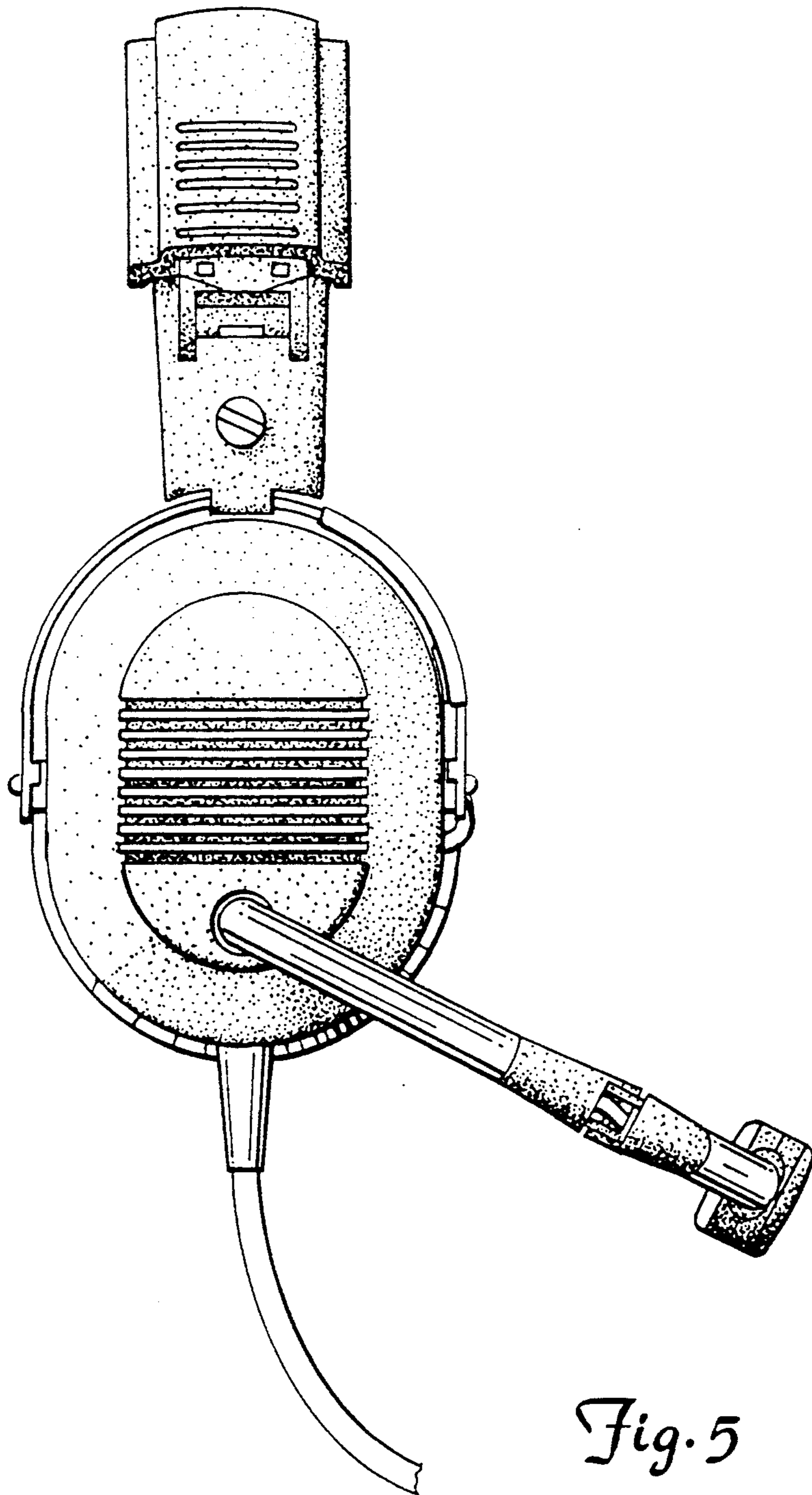

Fig. 5

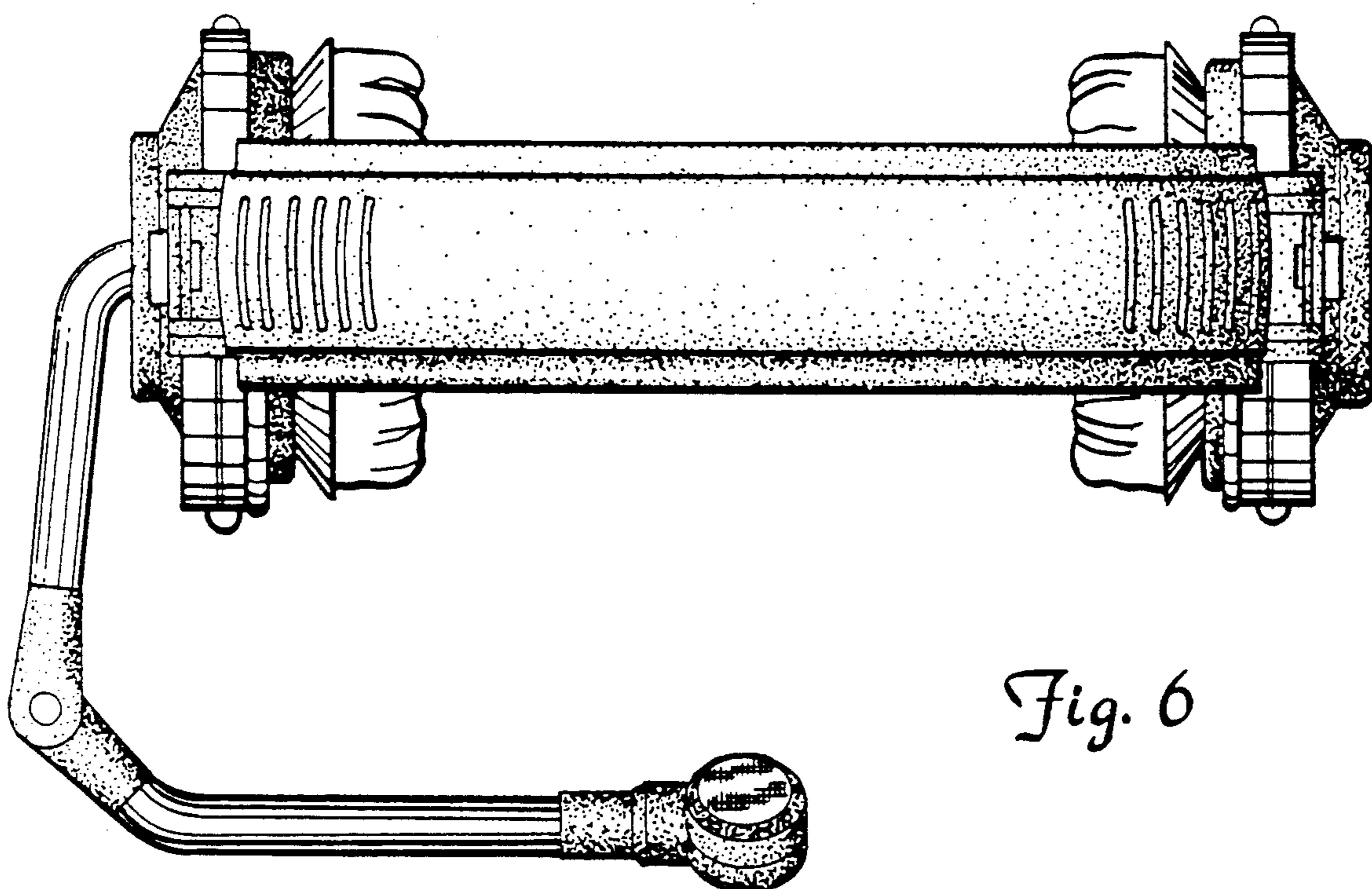

Fig. 6

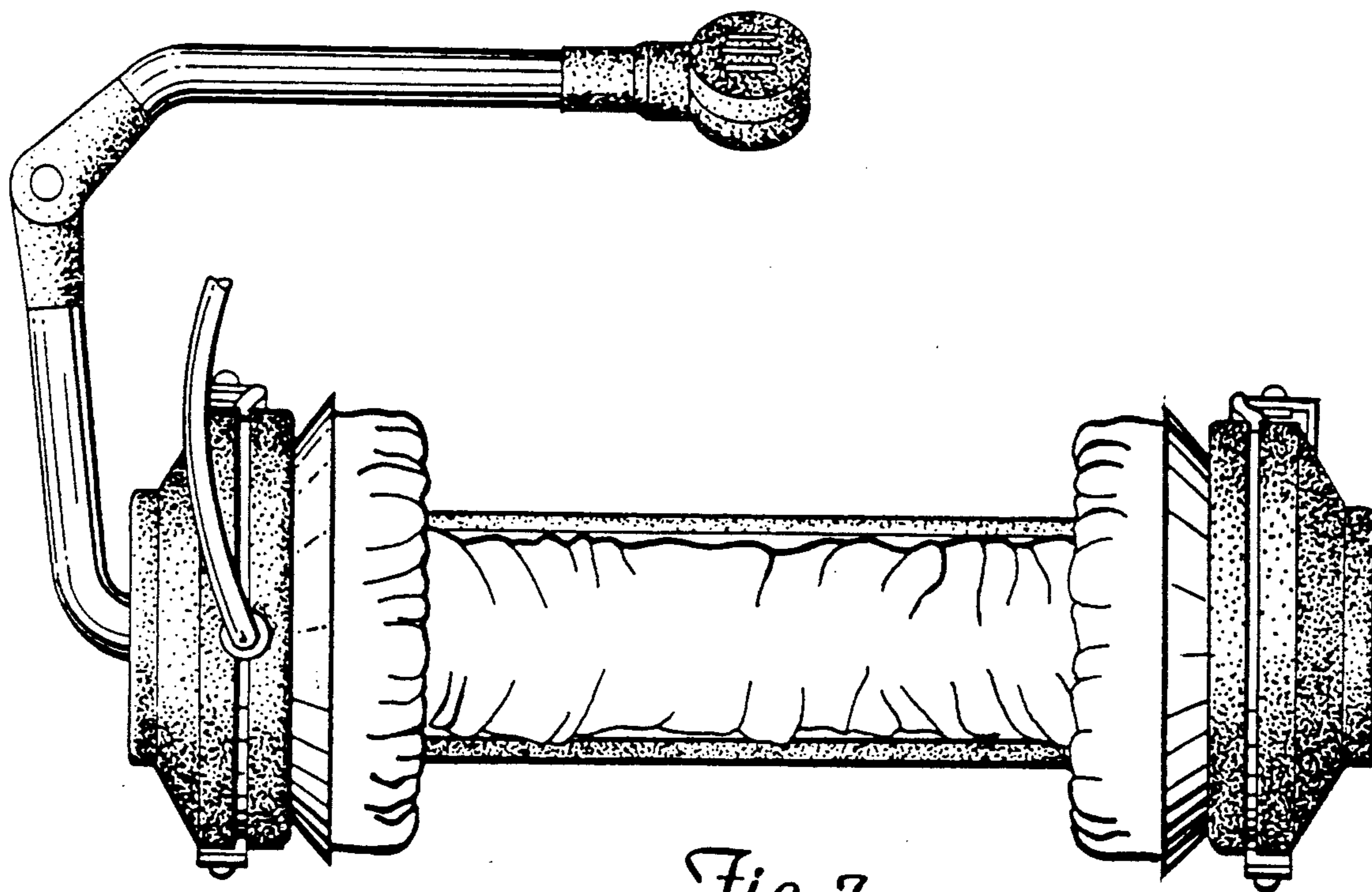

Fig. 7