



US00D345901S

# United States Patent [19]

[11] Patent Number: **Des. 345,901**

Fojtasek et al.

[45] Date of Patent: **\*\* Apr. 12, 1994**

[54] **DOOR HANDLE**

D. 271,560 11/1983 Valli ..... D8/308

[75] Inventors: **Randall S. Fojtasek, Dallas; Don W. Blackwell, Grapevine; Richard T. Abbott, Roanoke, all of Tex.**

### OTHER PUBLICATIONS

Domus Catalog; p. 5; lever 1002.

[73] Assignee: **The Atrium Door & Window Company, Dallas, Tex.**

*Primary Examiner*—B. J. Bullock  
*Attorney, Agent, or Firm*—Richards, Medlock & Andrews

[\*\*] Term: **14 Years**

### [57] CLAIM

[21] Appl. No.: **2,974**

The ornamental design for a door handle, as shown and described.

[22] Filed: **Dec. 23, 1992**

[52] U.S. Cl. .... **D8/308**

### DESCRIPTION

[58] Field of Search ..... **D8/300, 301, 306-308; 16/110 R, 111 R, 121; D23/250, 251, 254**

FIG. 1 is a perspective view of a door handle embodying our design;

### [56] References Cited

#### U.S. PATENT DOCUMENTS

- D. 81,026 4/1930 Schnell ..... D8/308
- D. 81,158 5/1930 Schnell ..... D8/308
- D. 83,809 3/1931 Jarvis ..... D8/308

FIG. 2 is a front elevational view thereof;

FIG. 3 is a right side elevational view thereof;

FIG. 4 is a left side elevational view thereof;

FIG. 5 is a rear elevational view thereof;

FIG. 6 is a top plan view thereof; and,

FIG. 7 is a bottom plan view thereof.



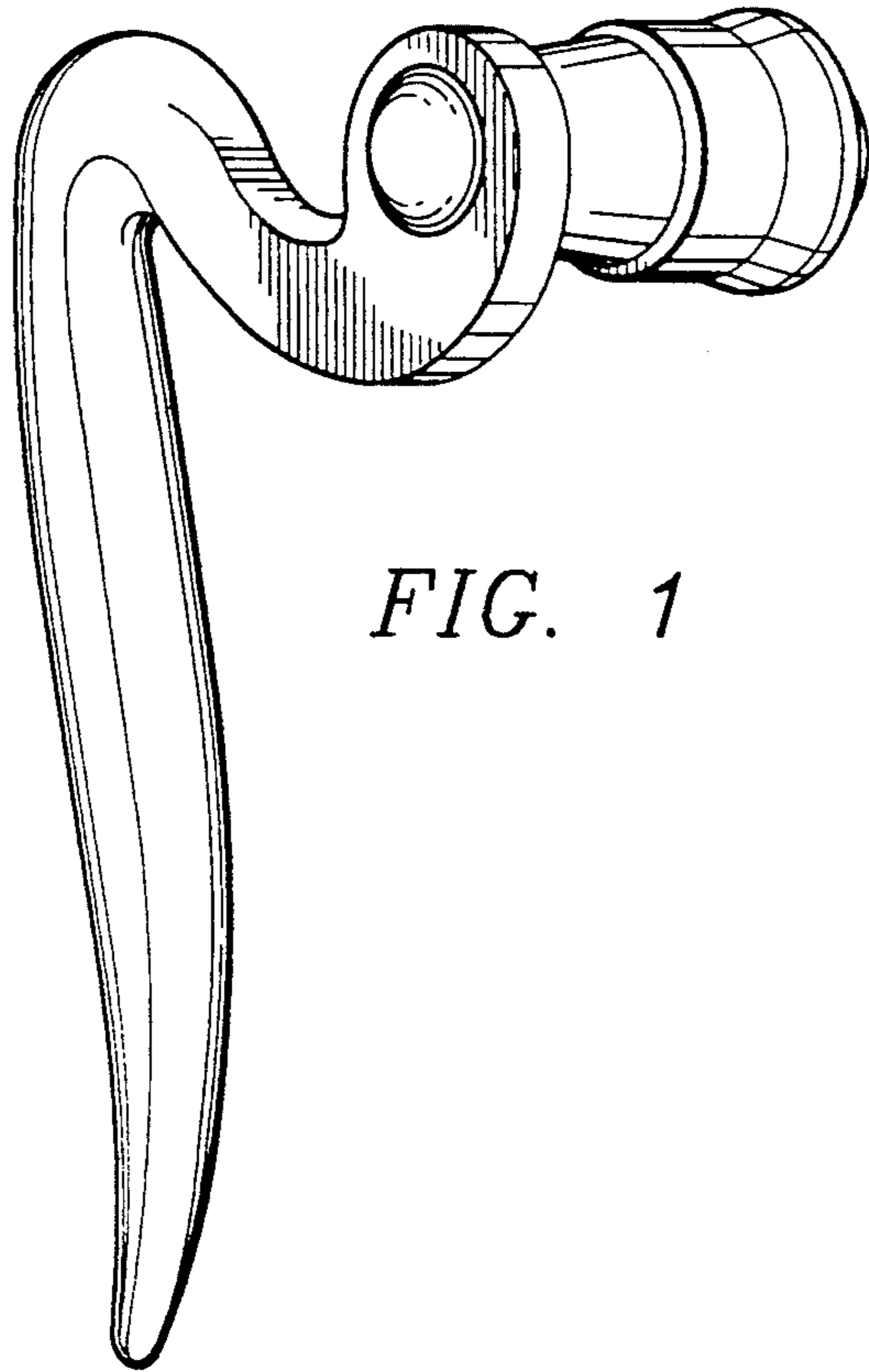

FIG. 1

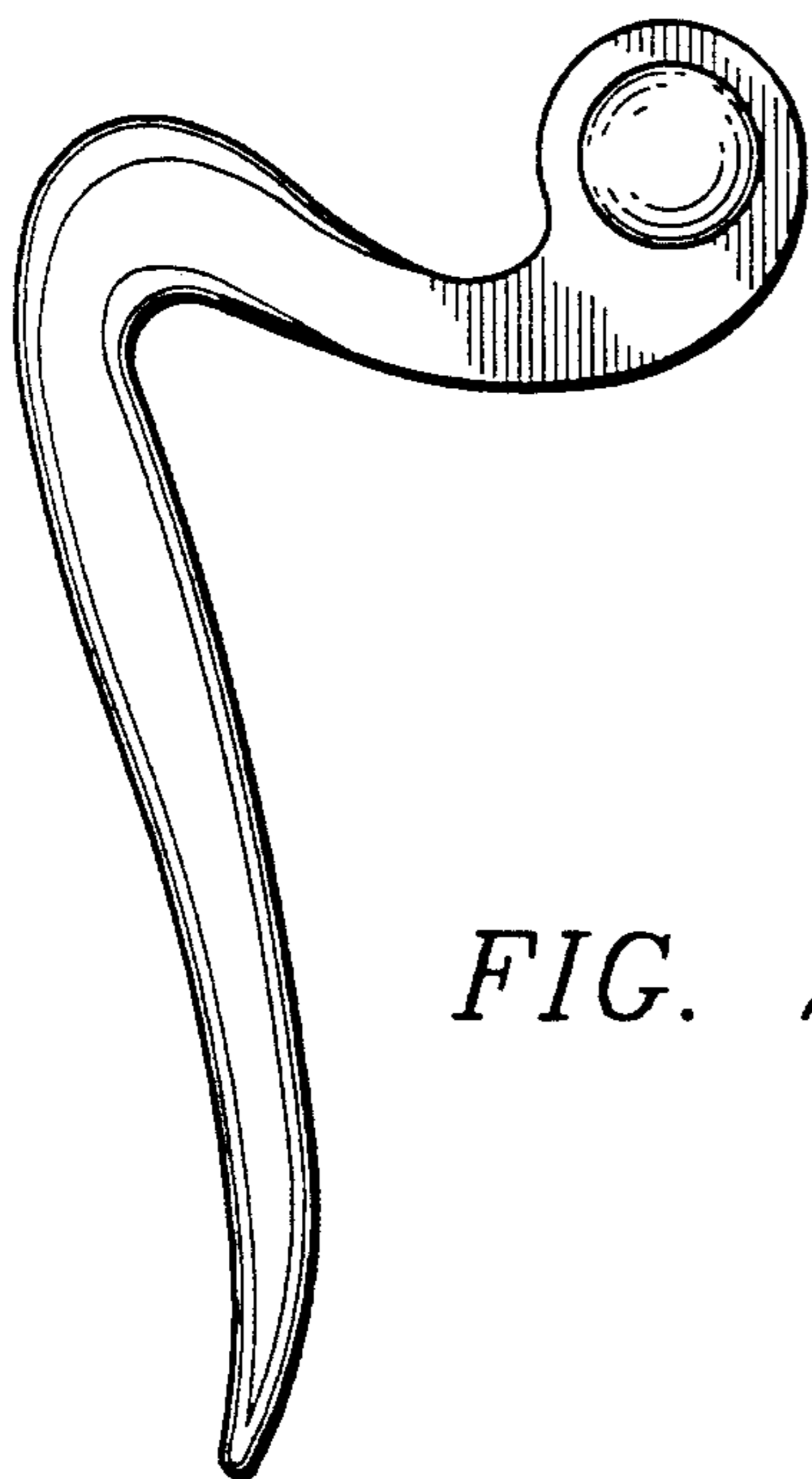

FIG. 2

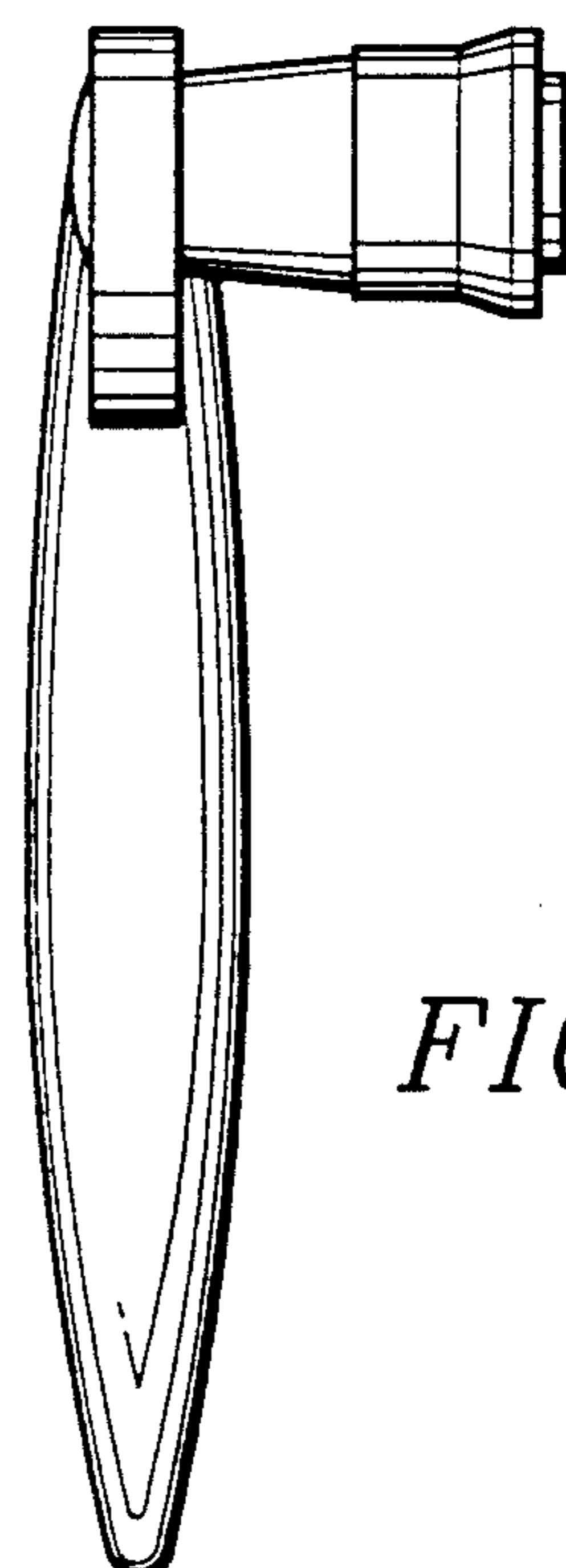

FIG. 3

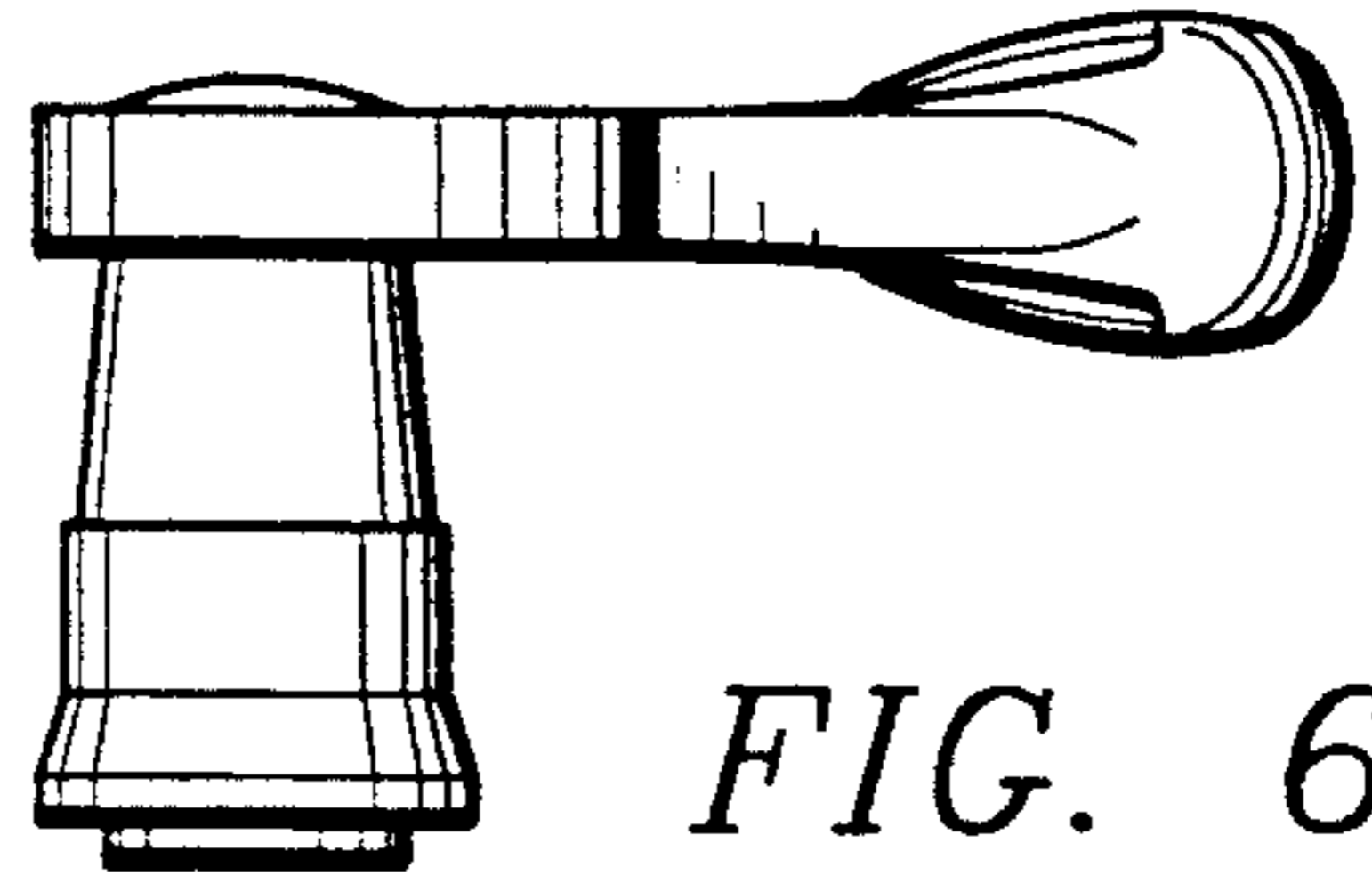

FIG. 6

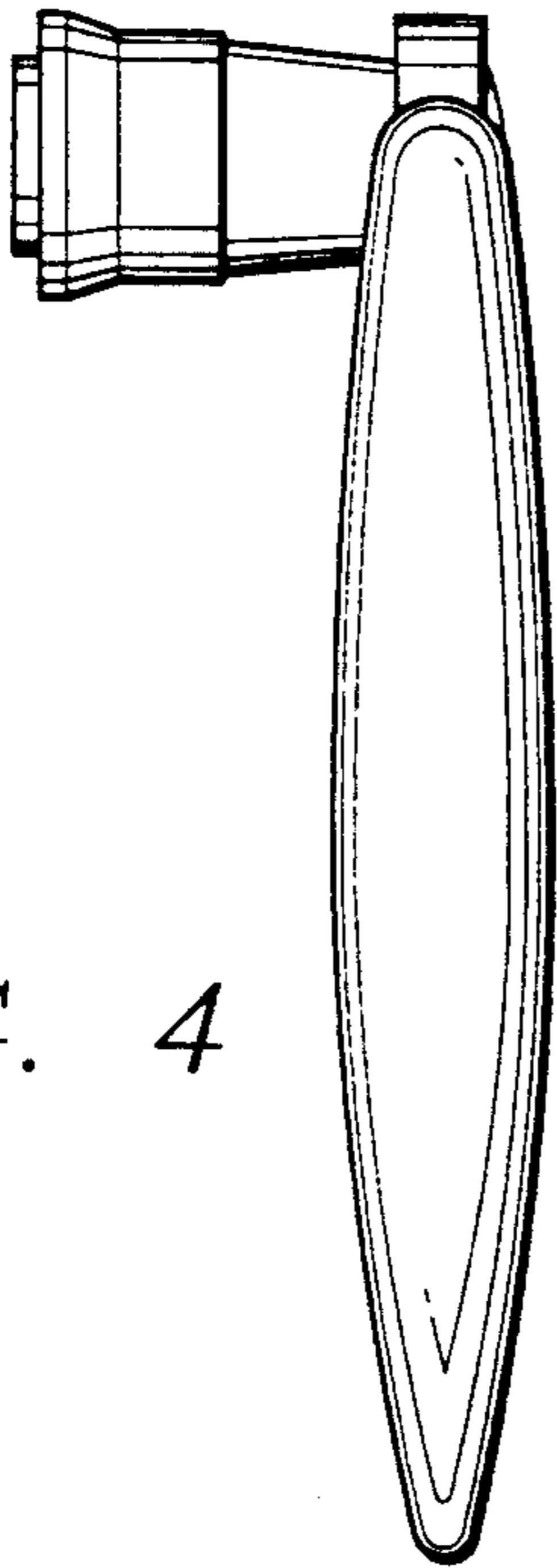

FIG. 4

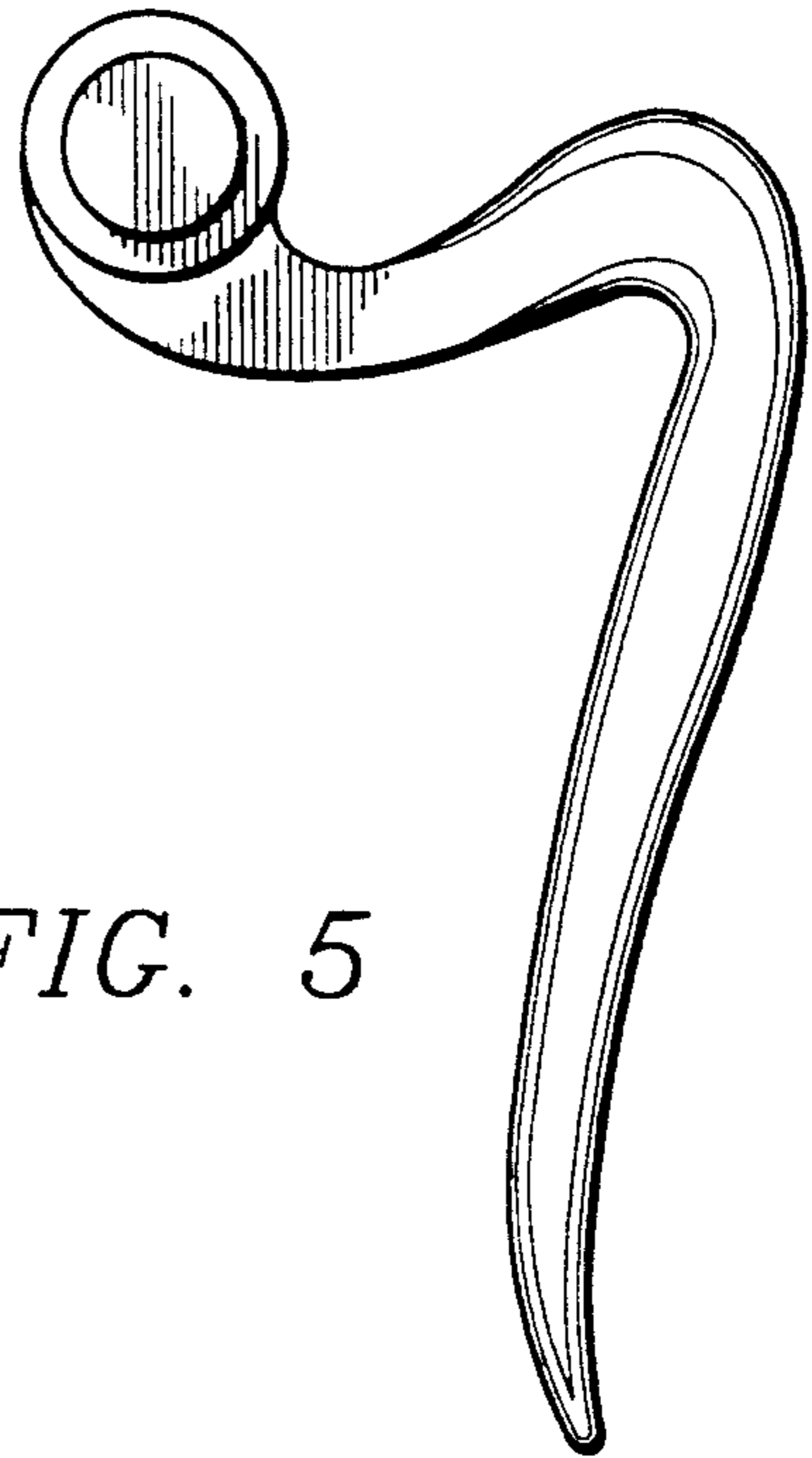

FIG. 5

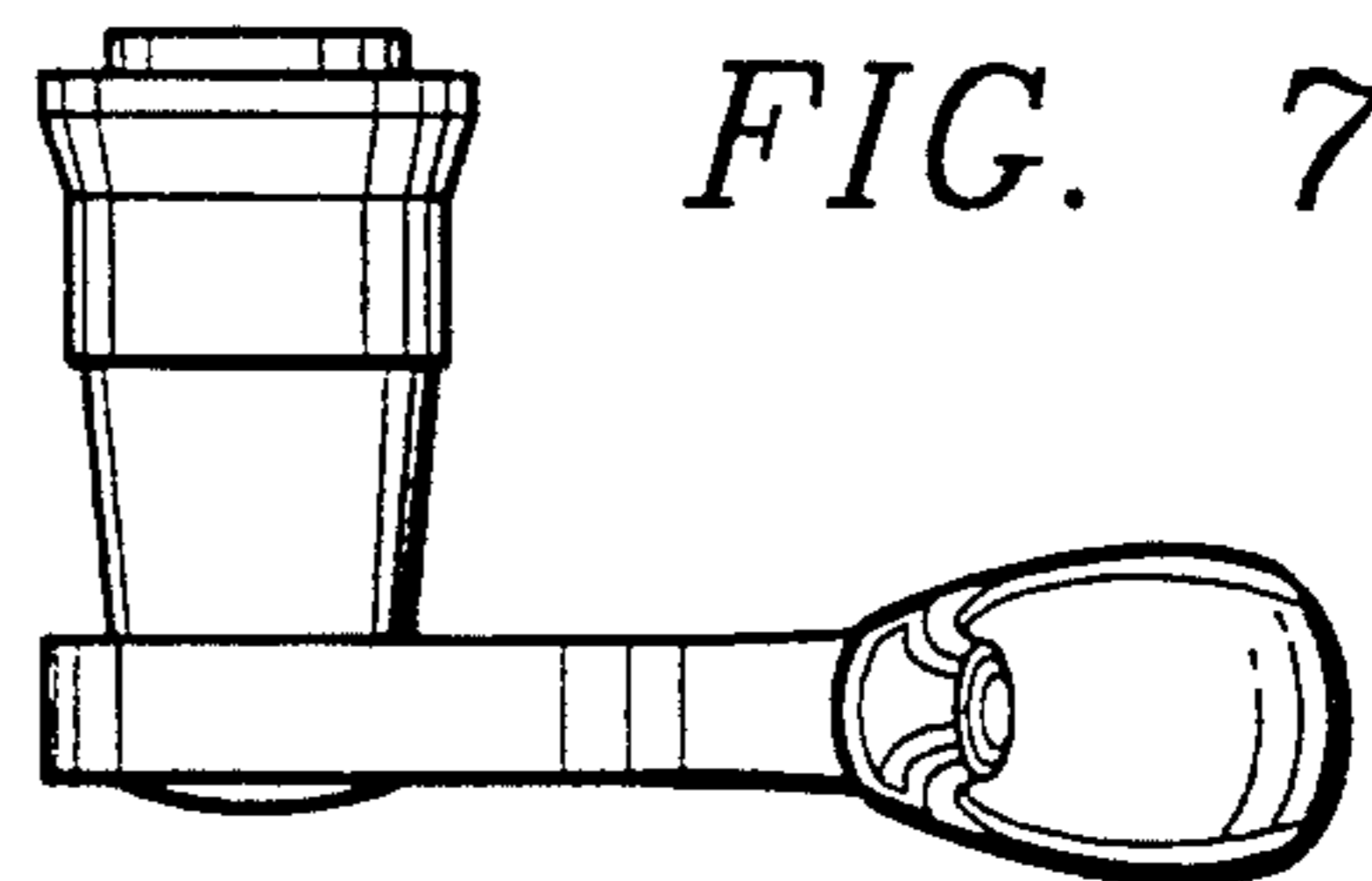

FIG. 7