



US00D345880S

# United States Patent [19]

[11] Patent Number: **Des. 345,880**

Classen

[45] Date of Patent: **\*\* Apr. 12, 1994**

[54] **PORTABLE MACHINE FOR BREWING HOT BEVERAGES**

4,764,954 11/1987 Mollenhoff ..... D7/309 X

[75] Inventor: **Bernd Classen**, Solingen, Fed. Rep. of Germany

[73] Assignee: **Robert Krups GmbH. & Co. KG**, Solingen, Fed. Rep. of Germany

[\*] Notice: The portion of the term of this patent subsequent to May 11, 2007 has been disclaimed.

[\*\*] Term: **14 Years**

[21] Appl. No.: **834,008**

[22] Filed: **Feb. 11, 1992**

[52] U.S. Cl. .... **D7/305; D7/310; D7/309**

[58] Field of Search ..... **D7/300, 533, 305, 536, D7/306, 309, 310, 311, 590, 507, 509, 312; 99/293, 279, 295, 300**

[56] **References Cited**

**U.S. PATENT DOCUMENTS**

- D. 286,848 11/1986 Levin ..... D7/309
- D. 295,888 5/1988 Schulein et al. .... D7/310 X
- D. 335,421 5/1993 Glassen ..... D7/309
- 4,577,080 3/1986 Grossman ..... 99/300 X
- 4,699,794 10/1987 Beice et al. .... 99/295 X

**OTHER PUBLICATIONS**

Diese Espressokanne/Schöner Wohnen p. 50, Aug. 1985.

One-Cup Wonder/Quick Cafe, Kitchen Essentials in House Beautiful Apr. 1986 p. 122.

HFD Singles 1 Cup Drip Coffeemaker Jan. 16, 1989.

*Primary Examiner*—Alan P. Douglas

*Assistant Examiner*—M. N. Pandozzi

*Attorney, Agent, or Firm*—Darby & Darby

[57] **CLAIM**

The ornamental design for a portable machine for brewing hot beverages, as shown and described.

**DESCRIPTION**

FIG. 1 is a top, front right side perspective view of a portable machine for brewing hot beverages showing my new design;

FIG. 2 is an exploded top, front right side perspective view thereof in operative position;

FIG. 3 is a left-hand side elevational view thereof;

FIG. 4 is a top plan view thereof;

FIG. 5 is a bottom plan view thereof;

FIG. 6 is a right-hand side elevational view thereof;

FIG. 7 is a rear elevational view thereof; and,

FIG. 8 is a front elevational view thereof.

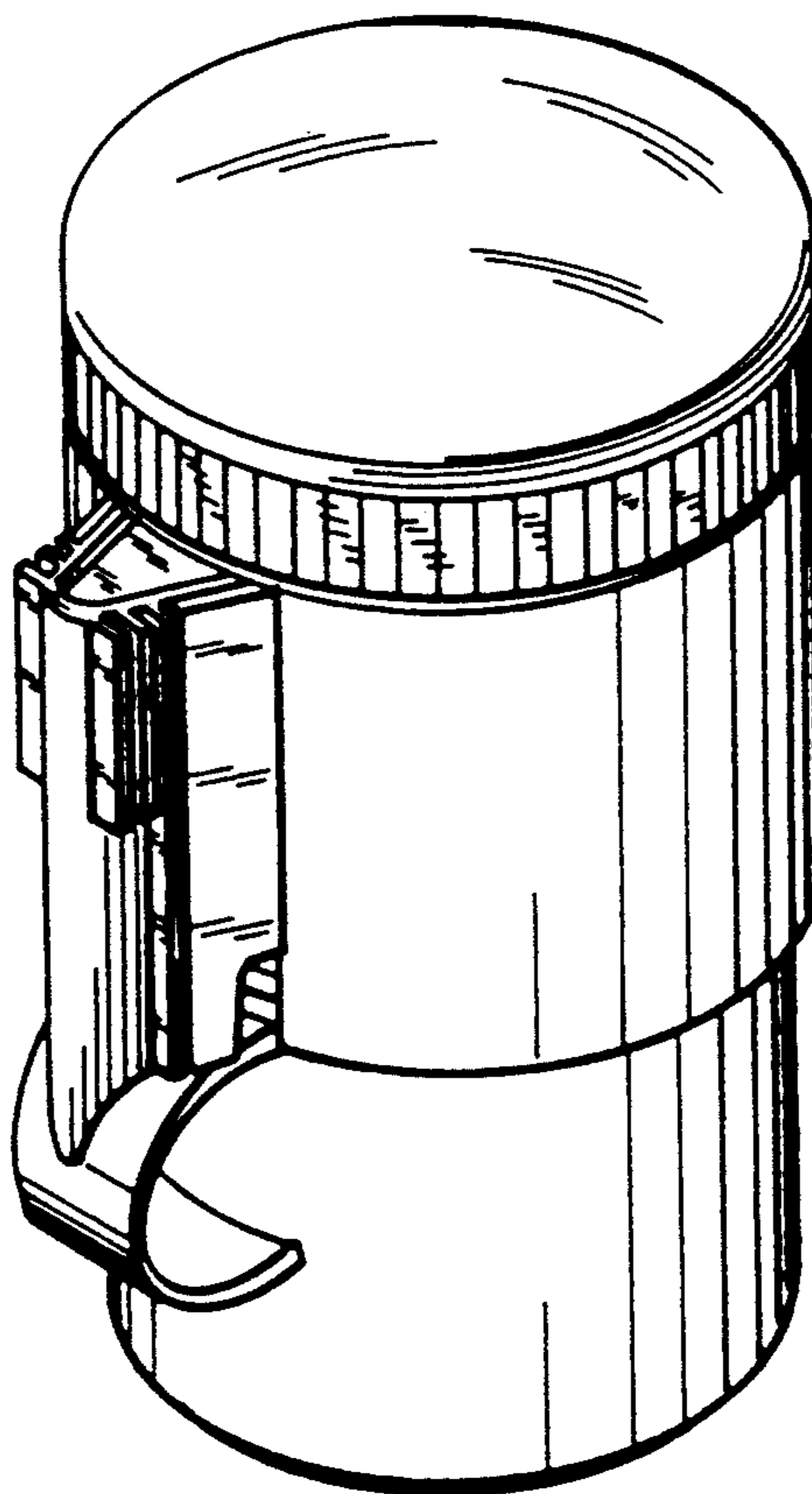

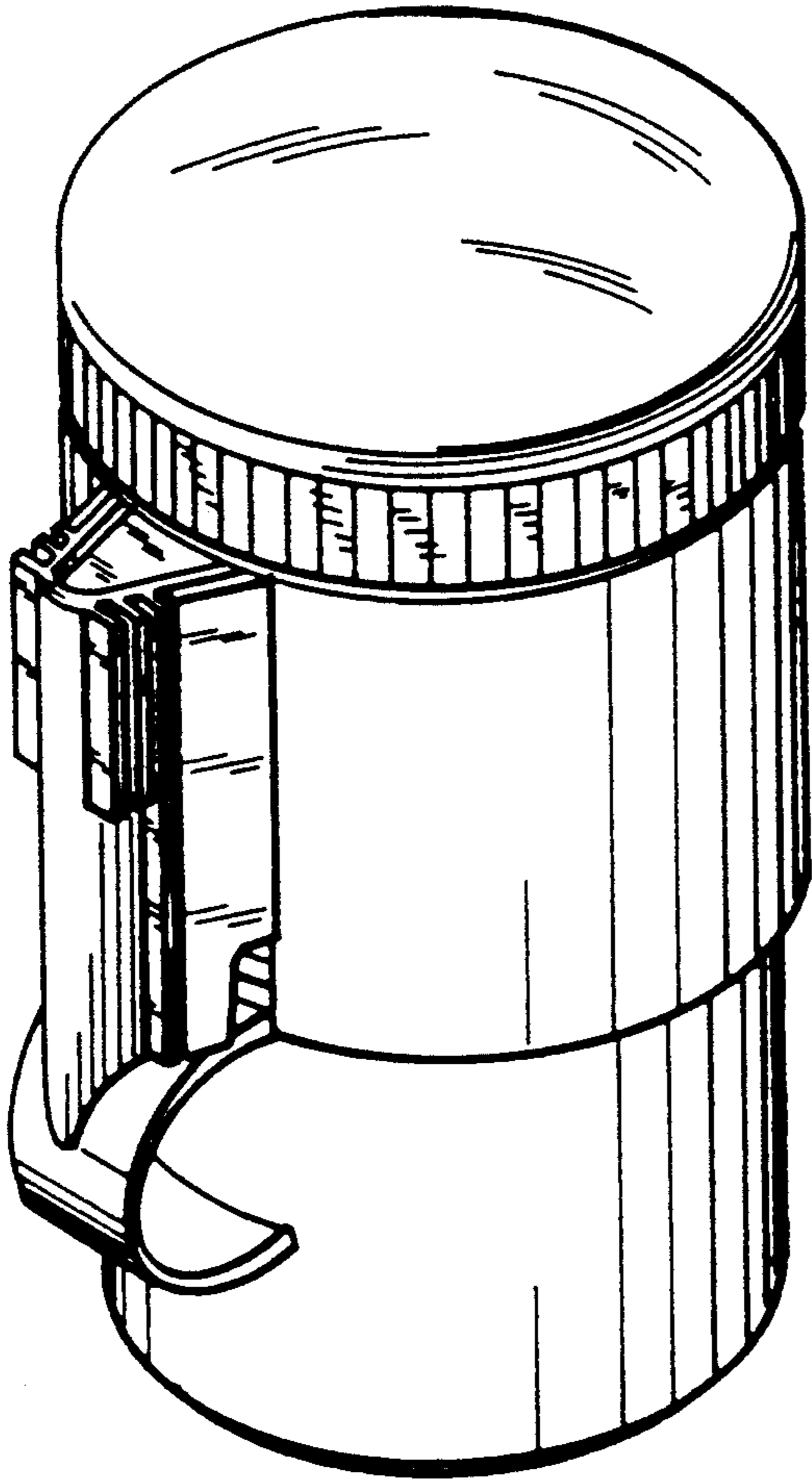

FIG. 1

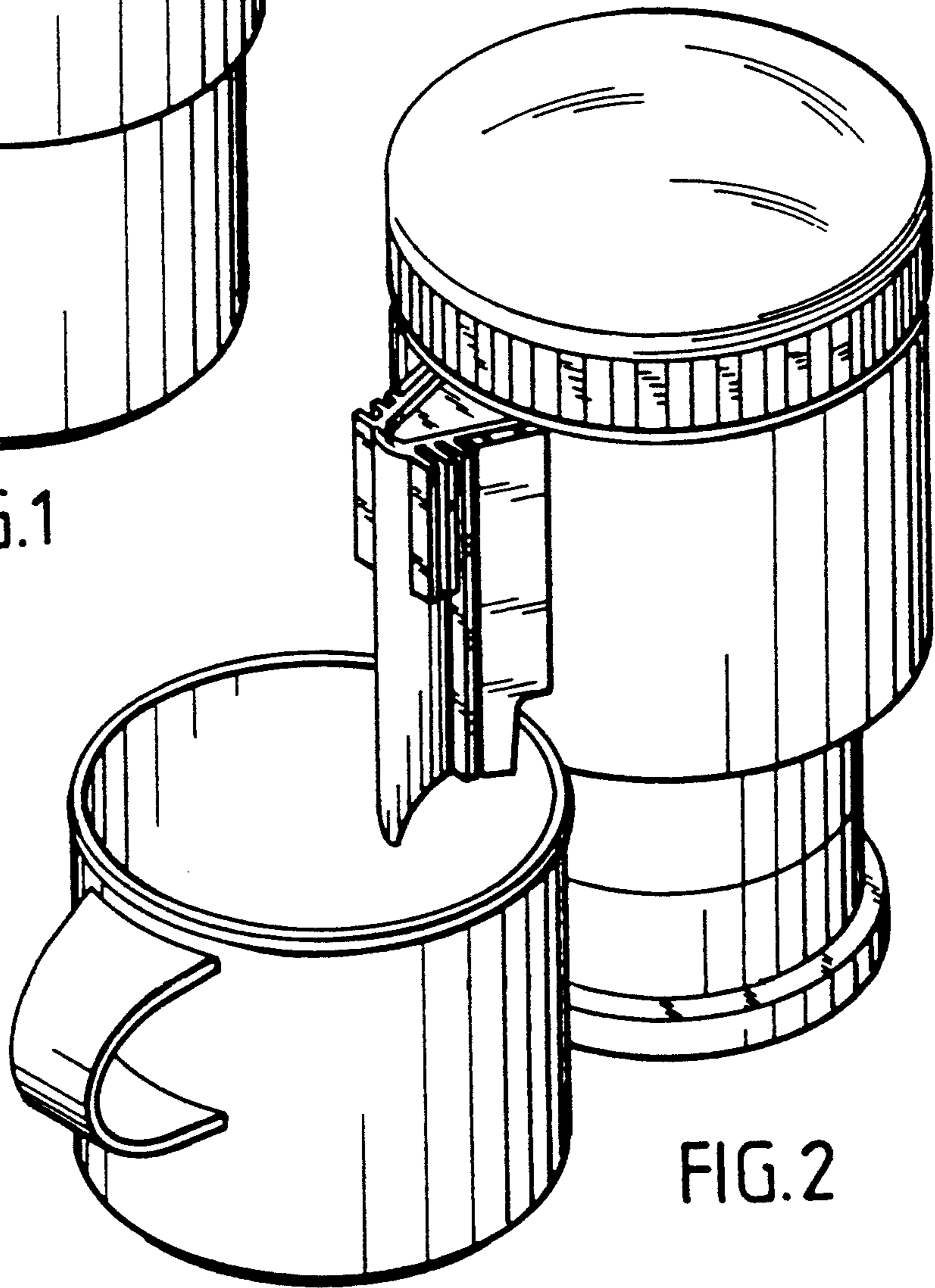

FIG. 2

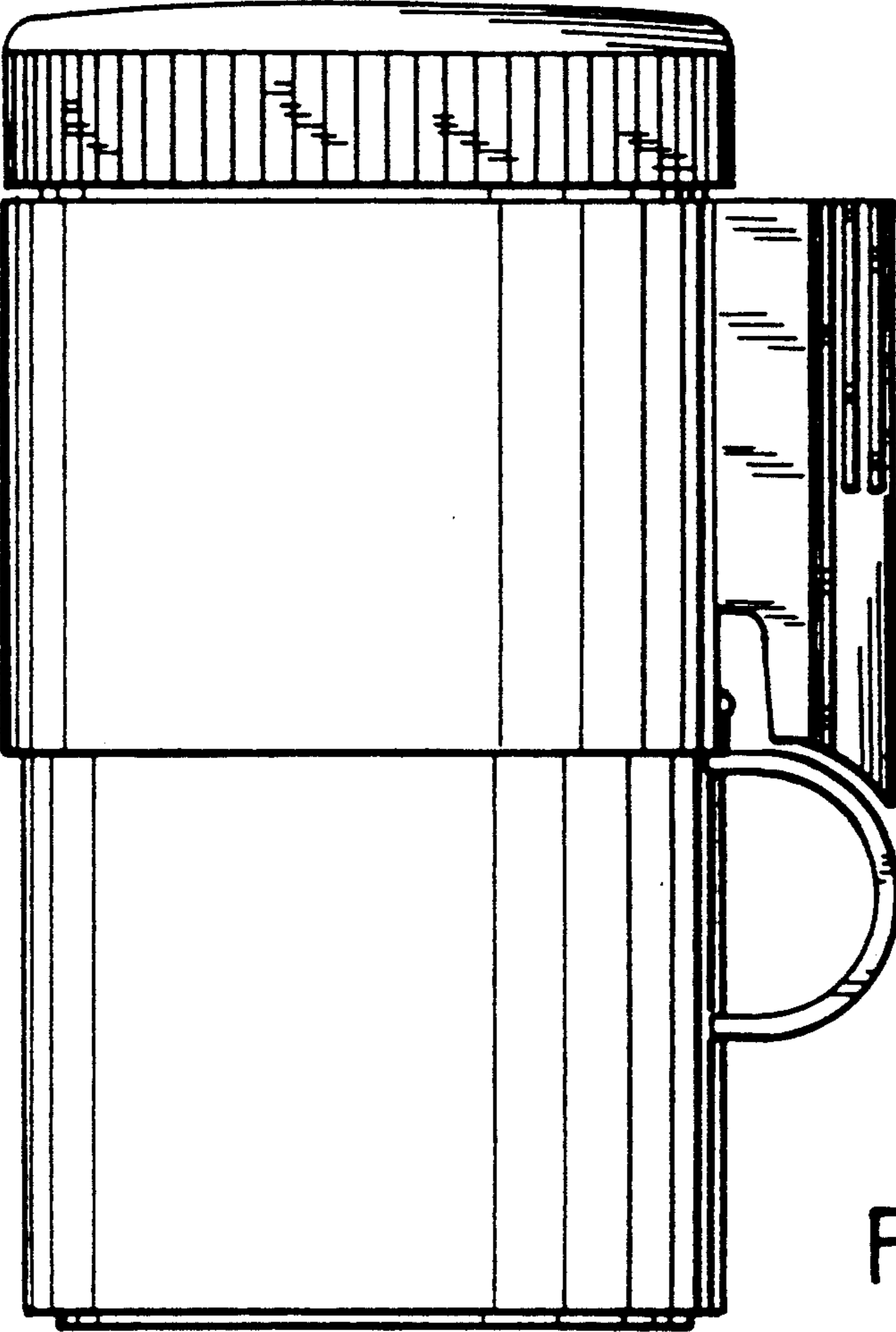

FIG.3

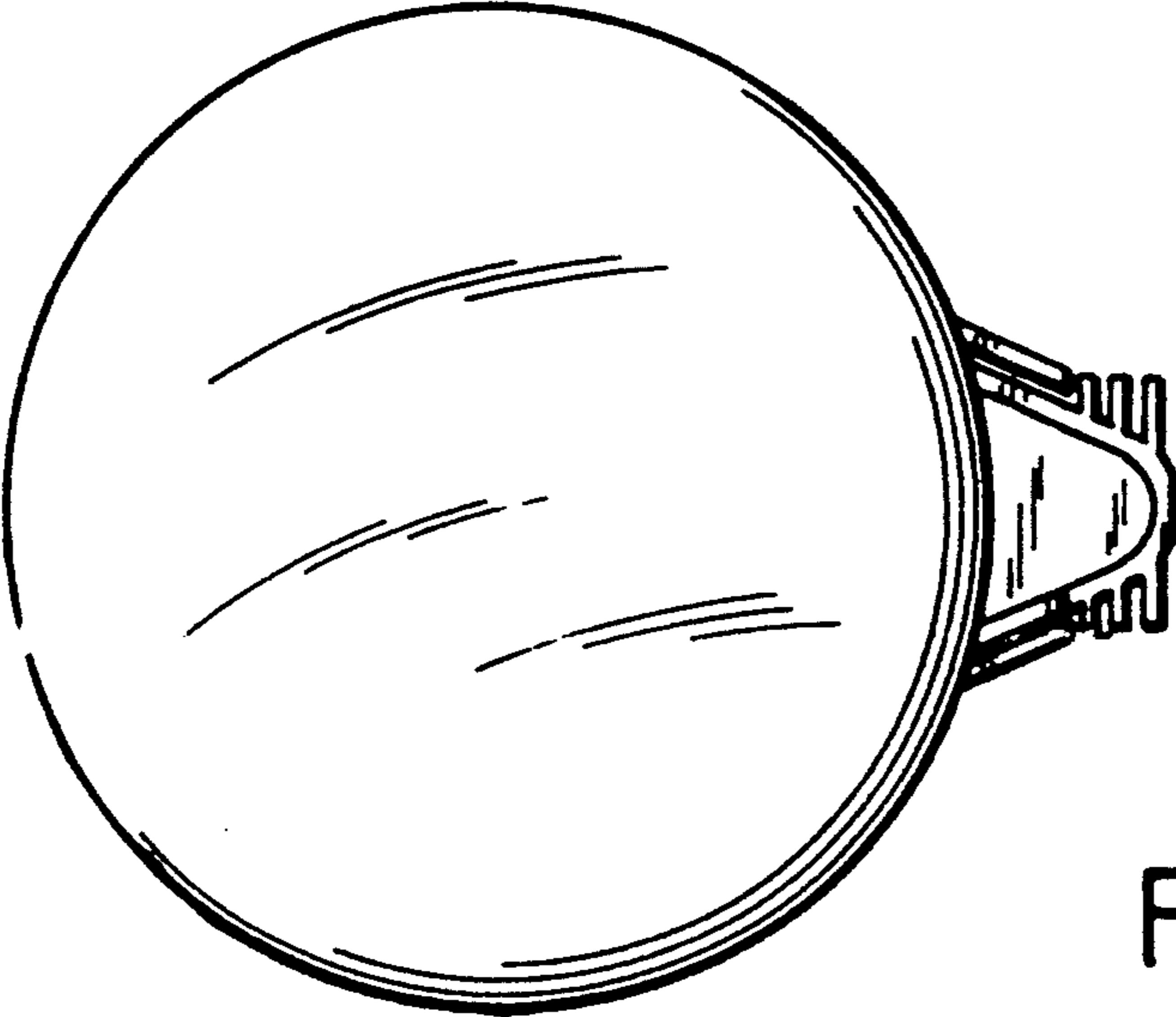

FIG.4

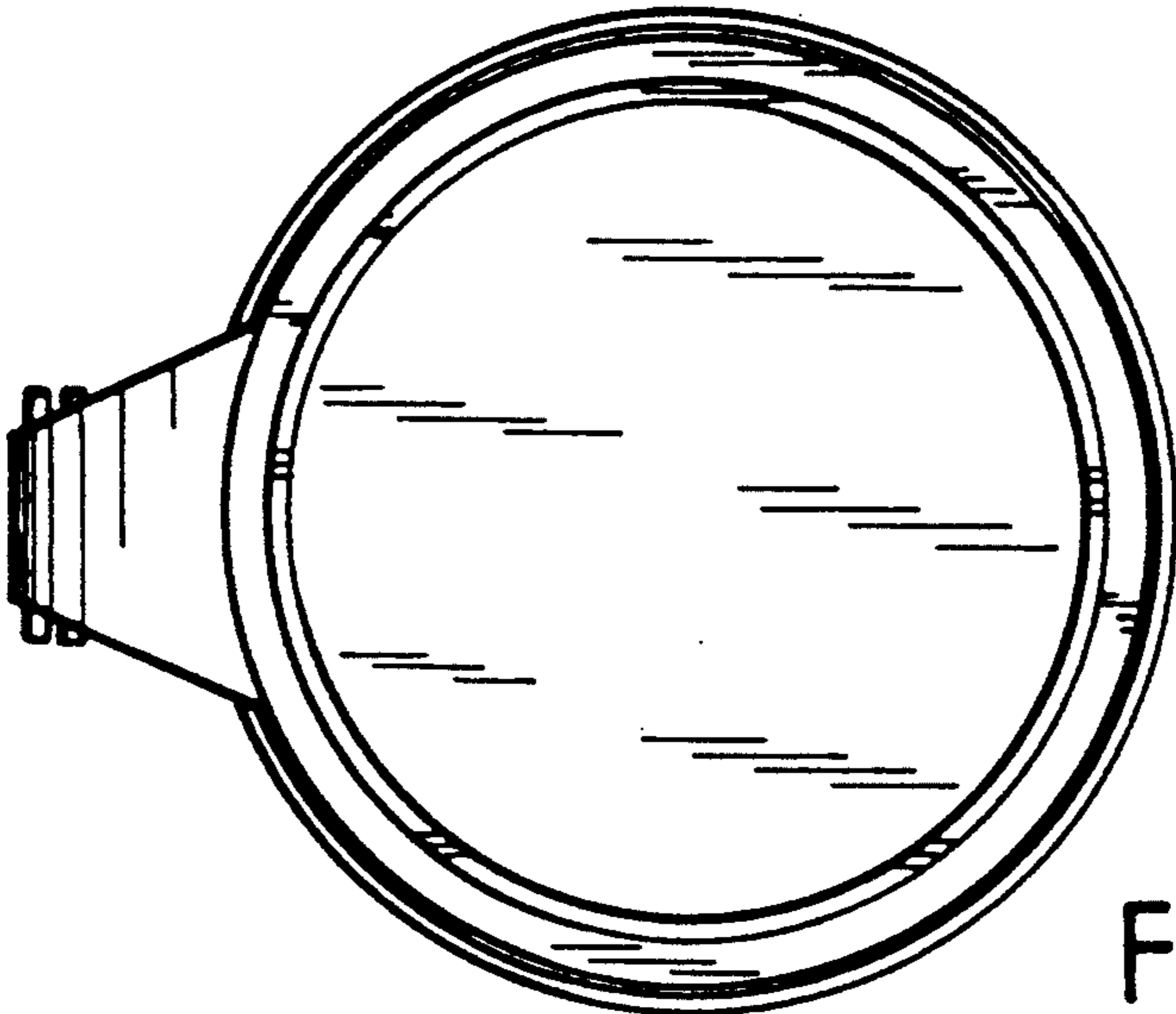

FIG. 5

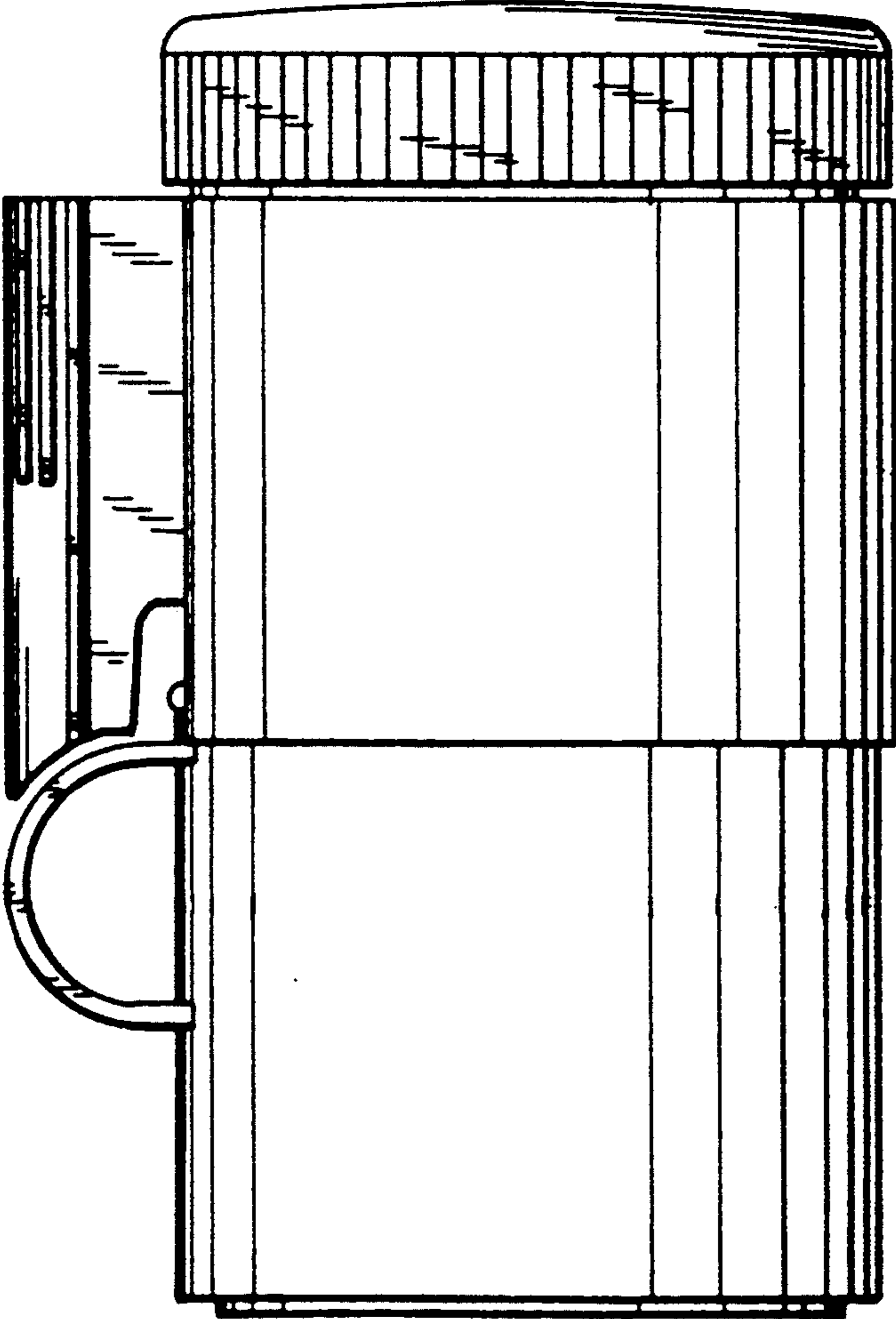

FIG. 6

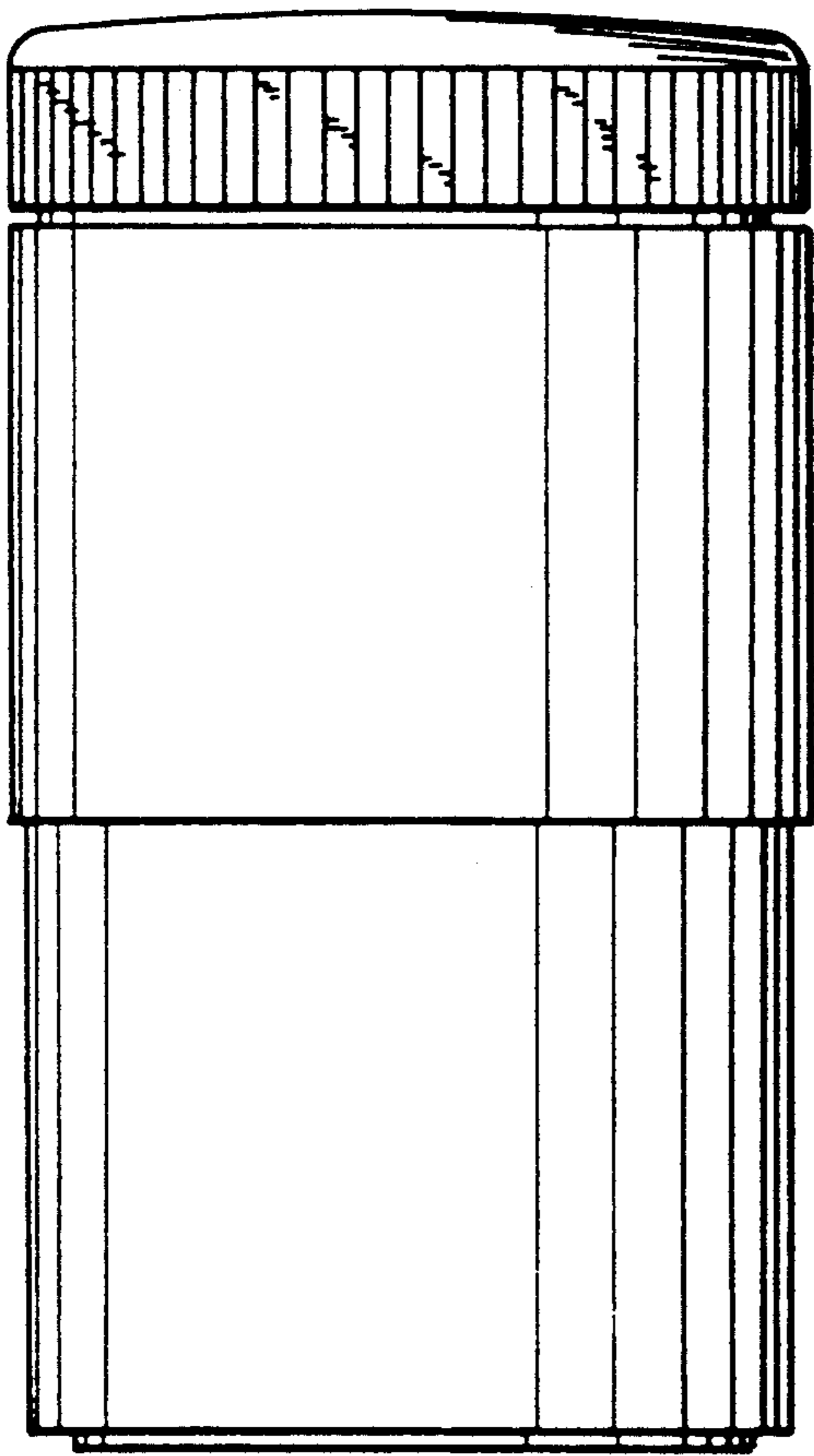

FIG. 7

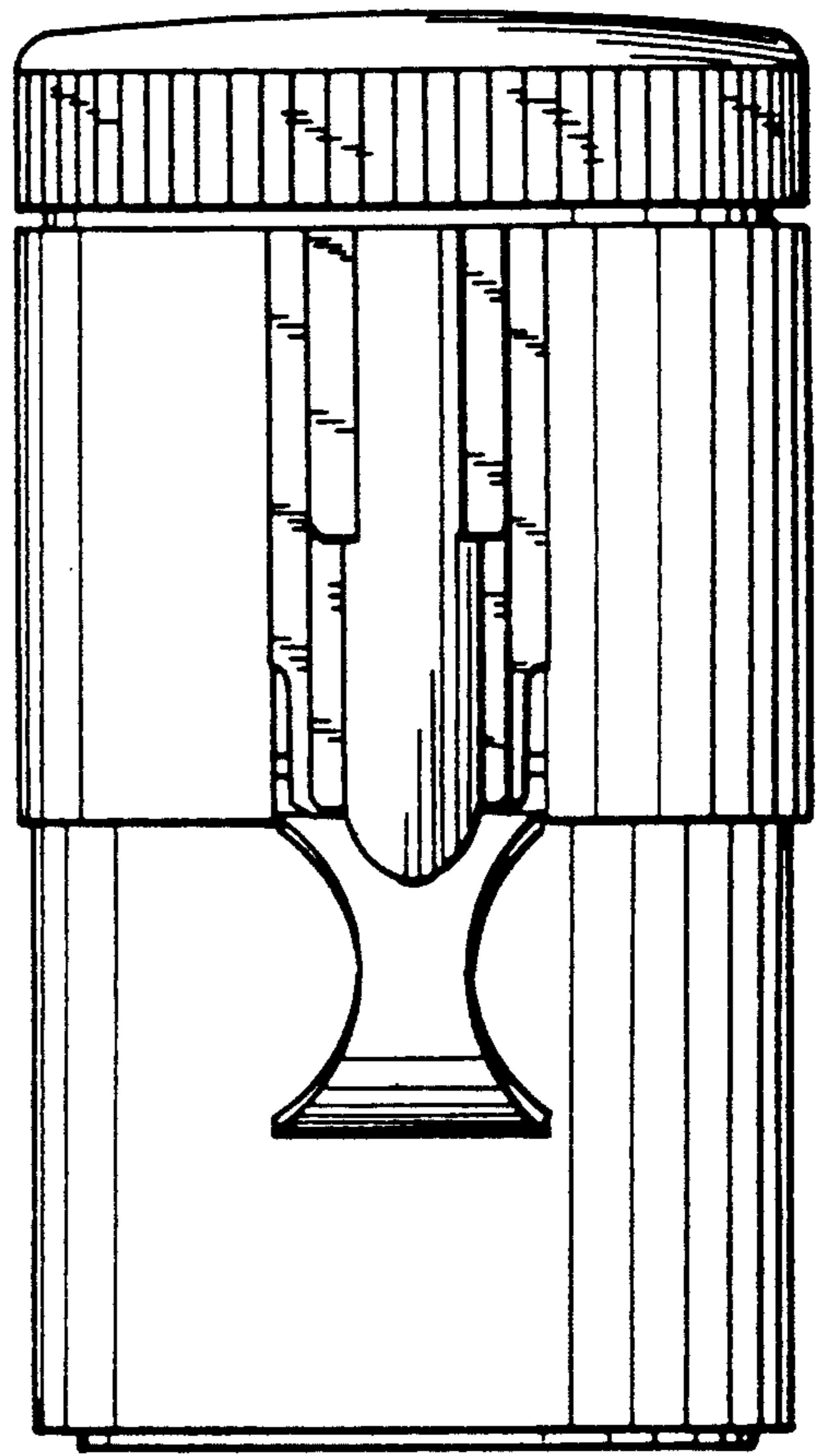

FIG. 8