



US00D345870S

United States Patent [19]

[11] Patent Number: **Des. 345,870**

Williams

[45] Date of Patent: **** Apr. 12, 1994**

[54] **WATER FILLED COUCH**

[76] Inventor: **Larry P. Williams**, Box 127,
Greenbush, Va. 23357

[**] Term: **14 Years**

[21] Appl. No.: **914,696**

[22] Filed: **Jul. 20, 1992**

[52] U.S. Cl. **D6/381**

[58] Field of Search **D6/334, 335, 364, 371,**
D6/381, 500, 501, 502; 297/232

[56] **References Cited**

U.S. PATENT DOCUMENTS

D. 241,590	9/1976	Kaplan	D6/381
D. 244,327	5/1977	Saltz	D6/381
D. 263,770	4/1982	Melchior	D6/334
D. 305,184	12/1989	Coley	D6/381
D. 318,183	7/1991	Fister, Jr.	D6/334
D. 326,367	5/1992	Messina	D6/335

OTHER PUBLICATIONS

Schweiger Industries, Sofa #02875-1175 shown at top.
Saladino Furniture, Club Sofa #131-84 shown.

Primary Examiner—Alan P. Douglas
Assistant Examiner—Gary D. Watson
Attorney, Agent, or Firm—Terry M. Gernstein

[57] **CLAIM**

The ornamental design for a water filled couch, as shown and described.

DESCRIPTION

FIG. 1 is an exploded front, end and top perspective view of the water filled couch showing my new design; FIG. 2 is an end elevational view thereof, the end opposite being a mirror image of the end shown in FIG. 2; FIG. 3 is a rear elevational view thereof; FIG. 4 is a front elevational view thereof; FIG. 5 is a top plan view thereof; and, FIG. 6 is a bottom plan view thereof.

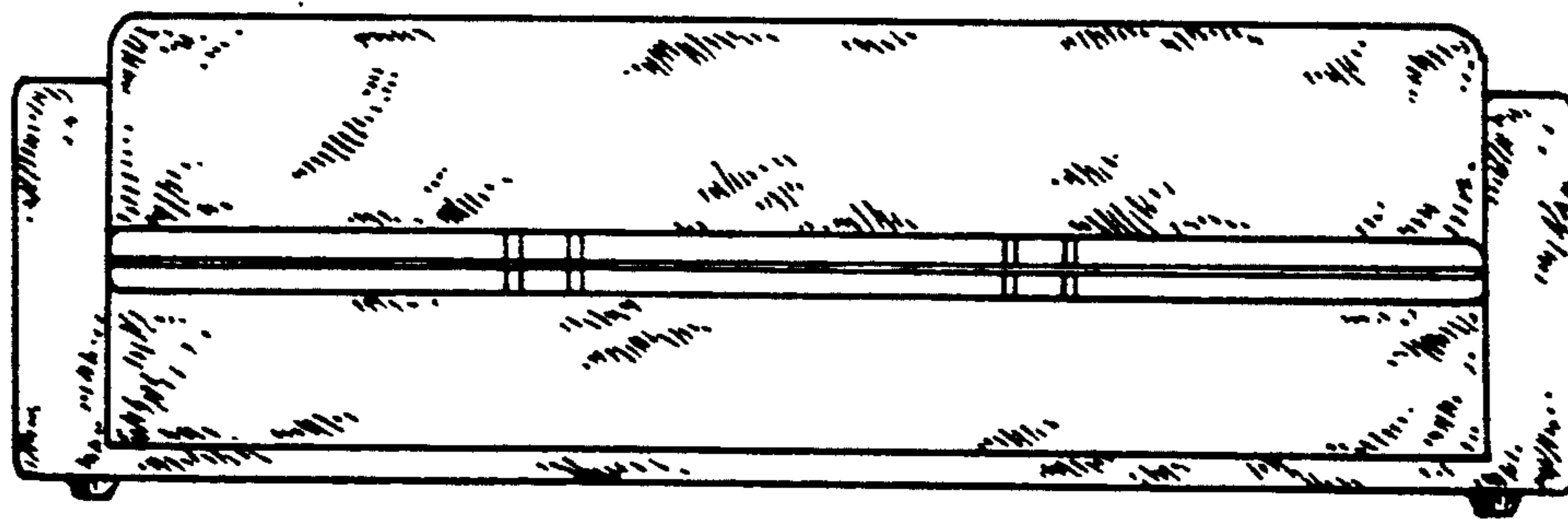

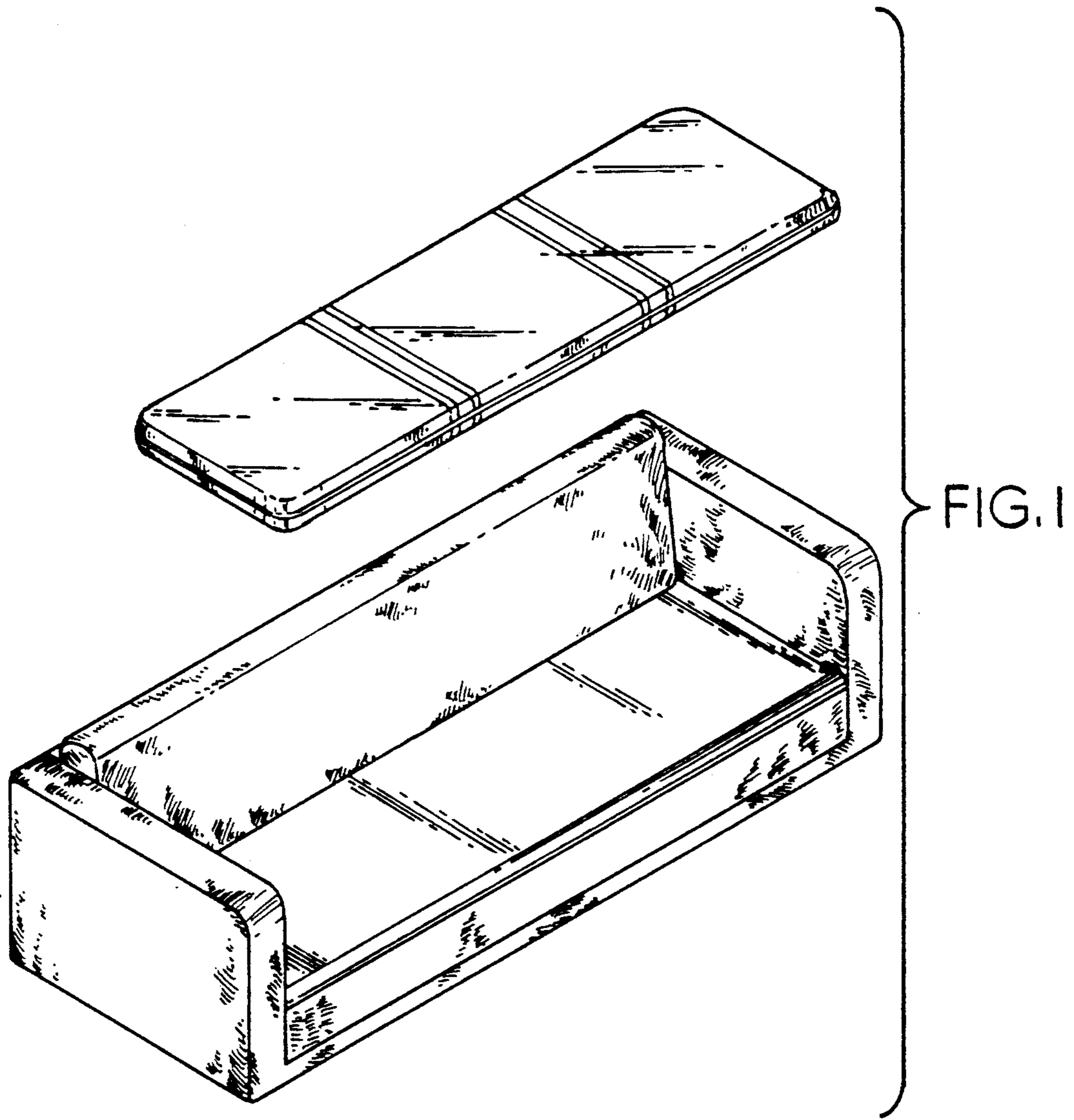

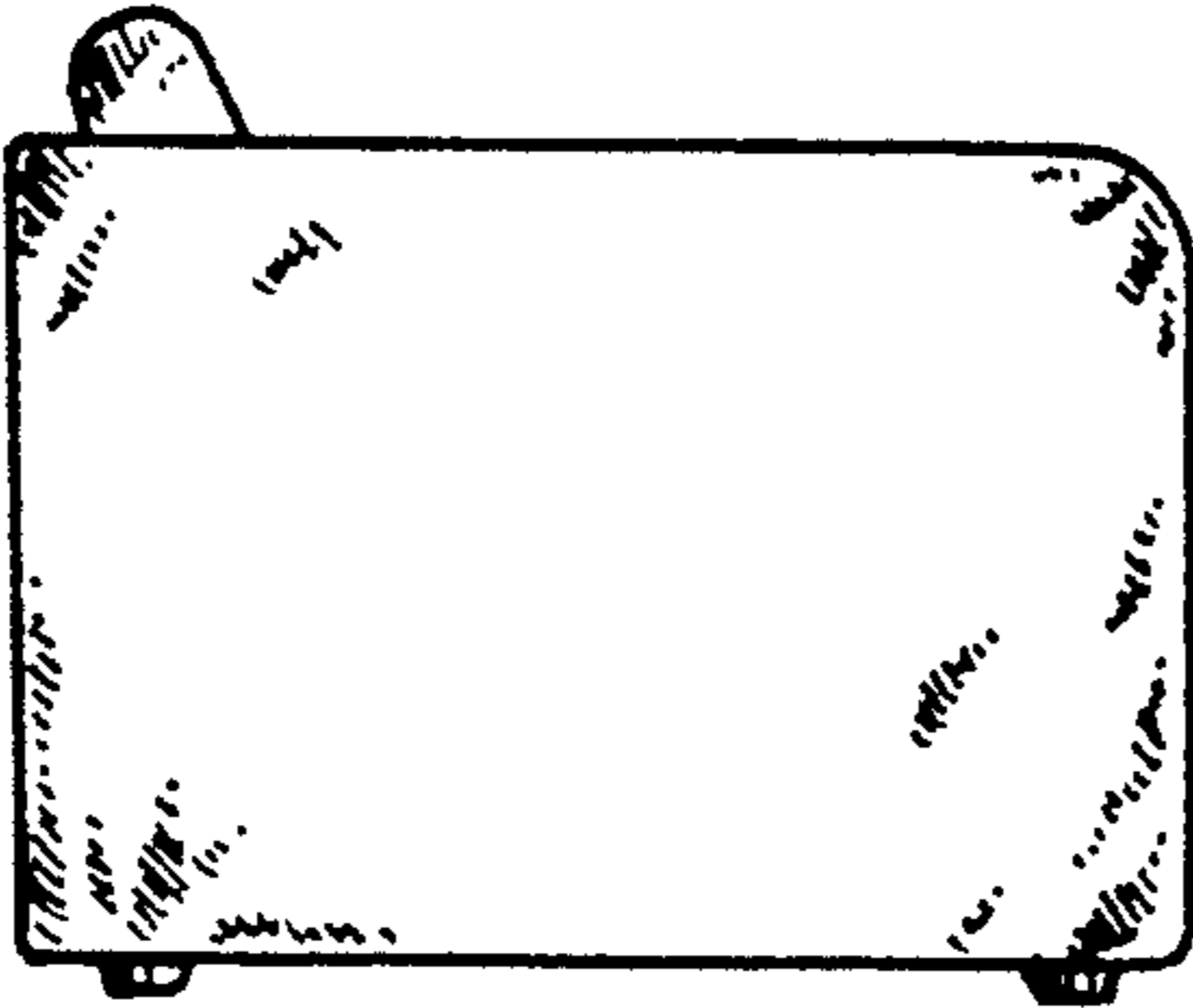

FIG. 2

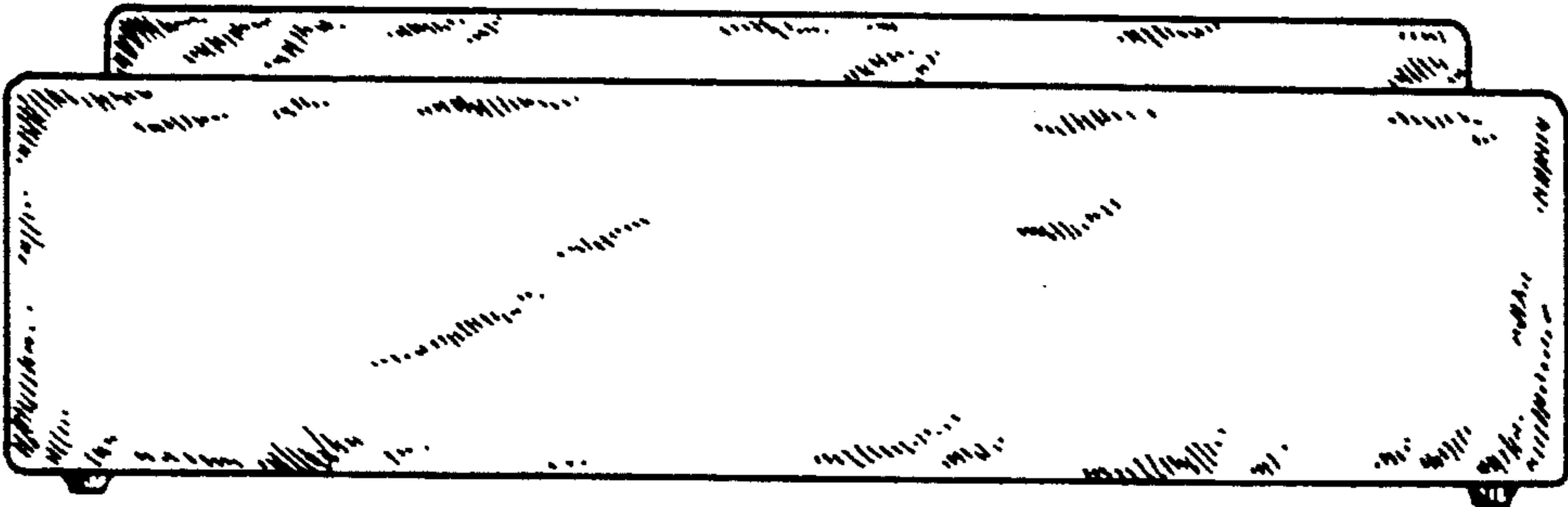

FIG. 3

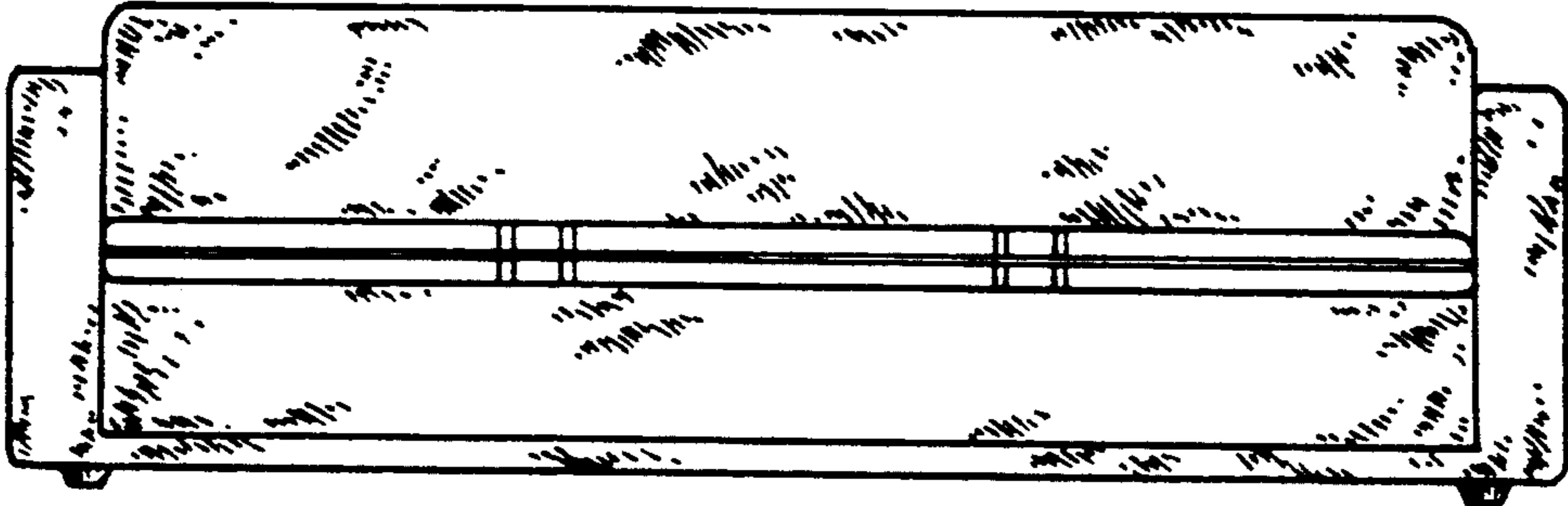

FIG. 4

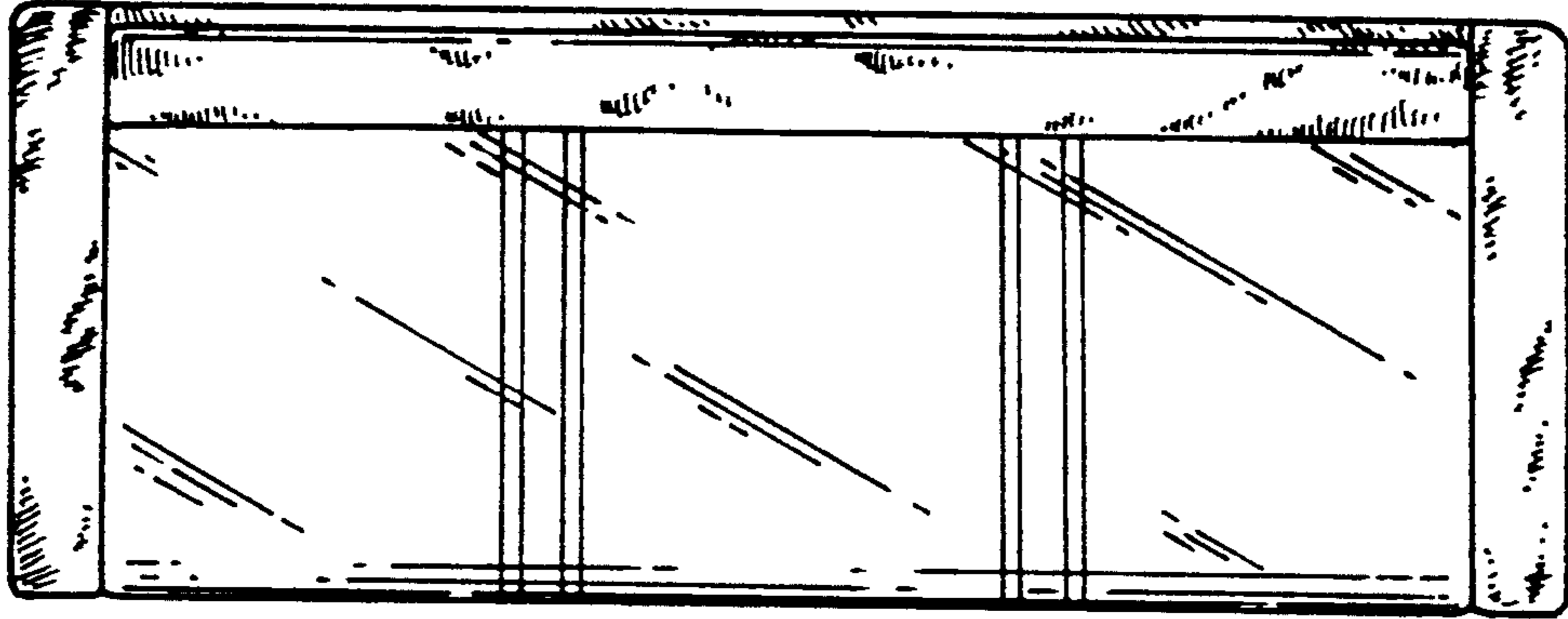

FIG. 5

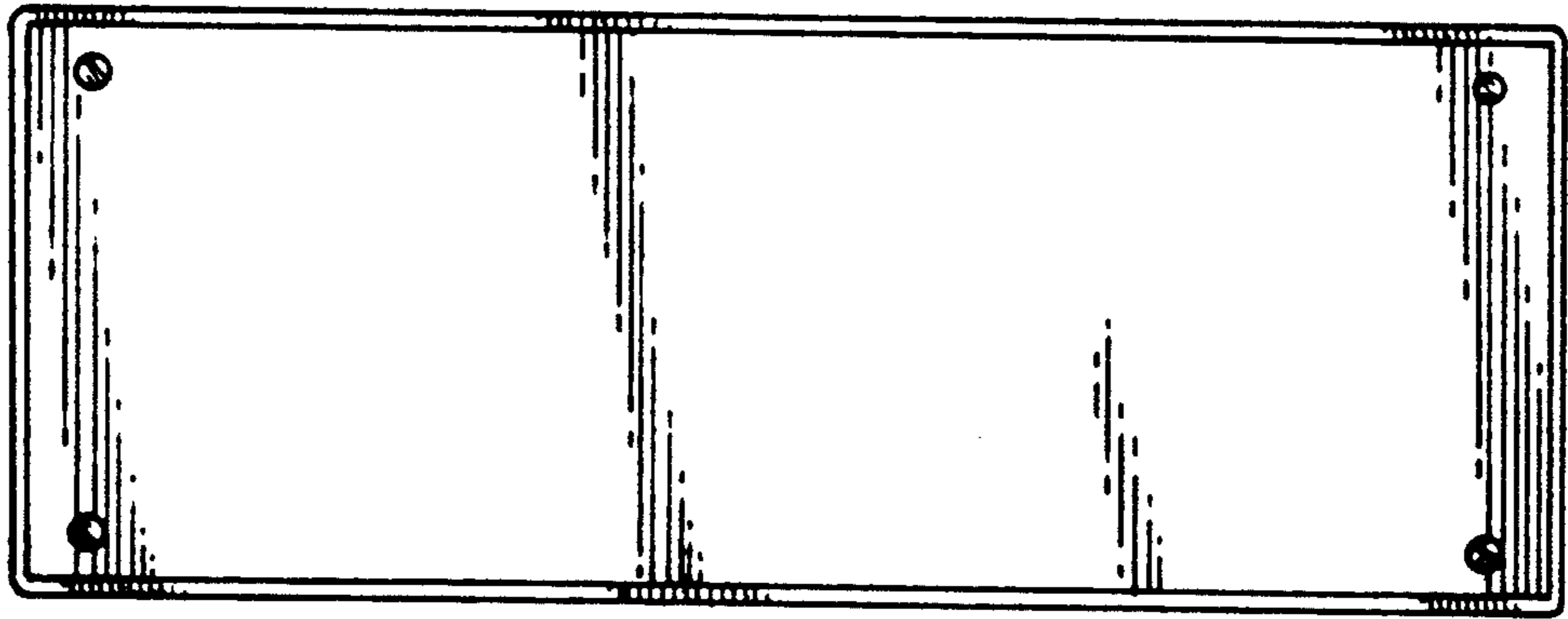

FIG. 6