



US00D345752S

United States Patent [19]

Noisette

[11] Patent Number: Des. 345,752

[45] Date of Patent: ** Apr. 5, 1994

[54] UNIT FOR DUBBING MUSIC ONTO CAMCORDER FILM

5,025,324 6/1991 Hashimoto 358/335

[76] Inventor: Emmanuel Noisette, 7545 N. Winchester #201, Chicago, Ill. 60626

[**] Term: 14 Years

[21] Appl. No.: 748,384

[22] Filed: Aug. 22, 1991

[52] U.S. Cl. D16/219

[58] Field of Search 358/335, 229, 906, 909; 352/34, 242, 243; 354/82, 288, 79; D16/202, 219, 237, 246

OTHER PUBLICATIONS

Modern Photography; May 1988; p. 45; Minolta C3400.

Primary Examiner—Bernard Ansher

Assistant Examiner—M. Siegel

Attorney, Agent, or Firm—Terry M. Gernstein

[57] CLAIM

The ornamental design for a unit for dubbing music onto camcorder film, as shown and described.

DESCRIPTION

FIG. 1 is a perspective view of a unit for dubbing music onto camcorder film showing my new design; FIG. 2 is an enlarged left end elevational view thereof; FIG. 3 is a right end elevational view of FIG. 2; FIG. 4 is a front elevational view of FIG. 2, the undisclosed opposite side being identical; FIG. 5 is a top plan view of FIG. 2; and, FIG. 6 is a bottom plan view of FIG. 2. The broken line showing of a video camera is for illustrative purposes only and forms no part of the claimed design.

[56] References Cited

U.S. PATENT DOCUMENTS

D. 297,644	9/1988	Sugiyama et al.	D16/219
D. 305,240	12/1989	Kondoh	D16/202
D. 316,555	4/1991	Ooi et al.	D16/202
D. 328,087	7/1992	Shibata et al.	D16/202
3,963,331	6/1976	Komine .	
4,226,510	10/1980	Svatek .	
4,226,511	10/1980	Wright .	
4,450,487	5/1984	Koide	358/335

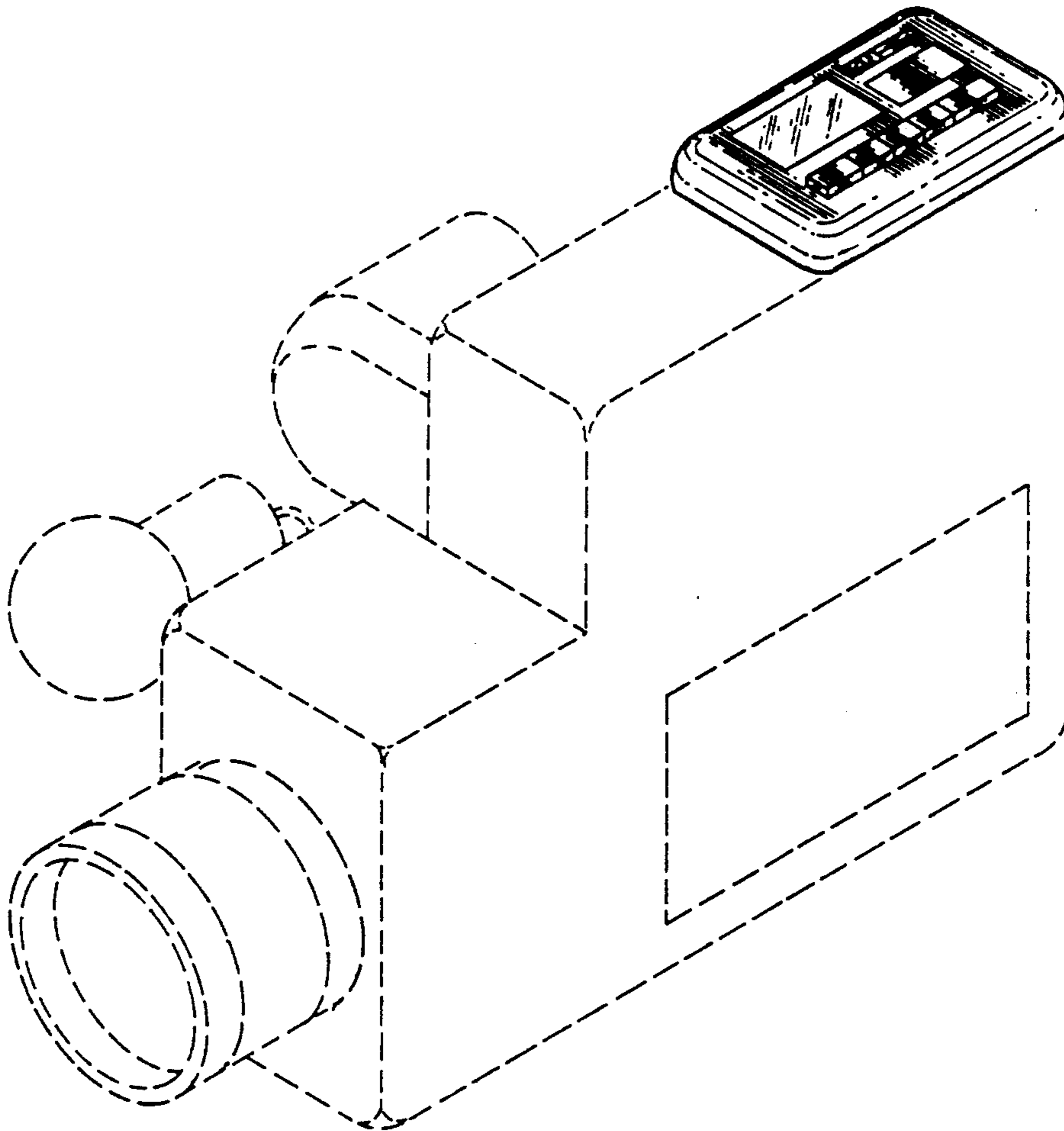
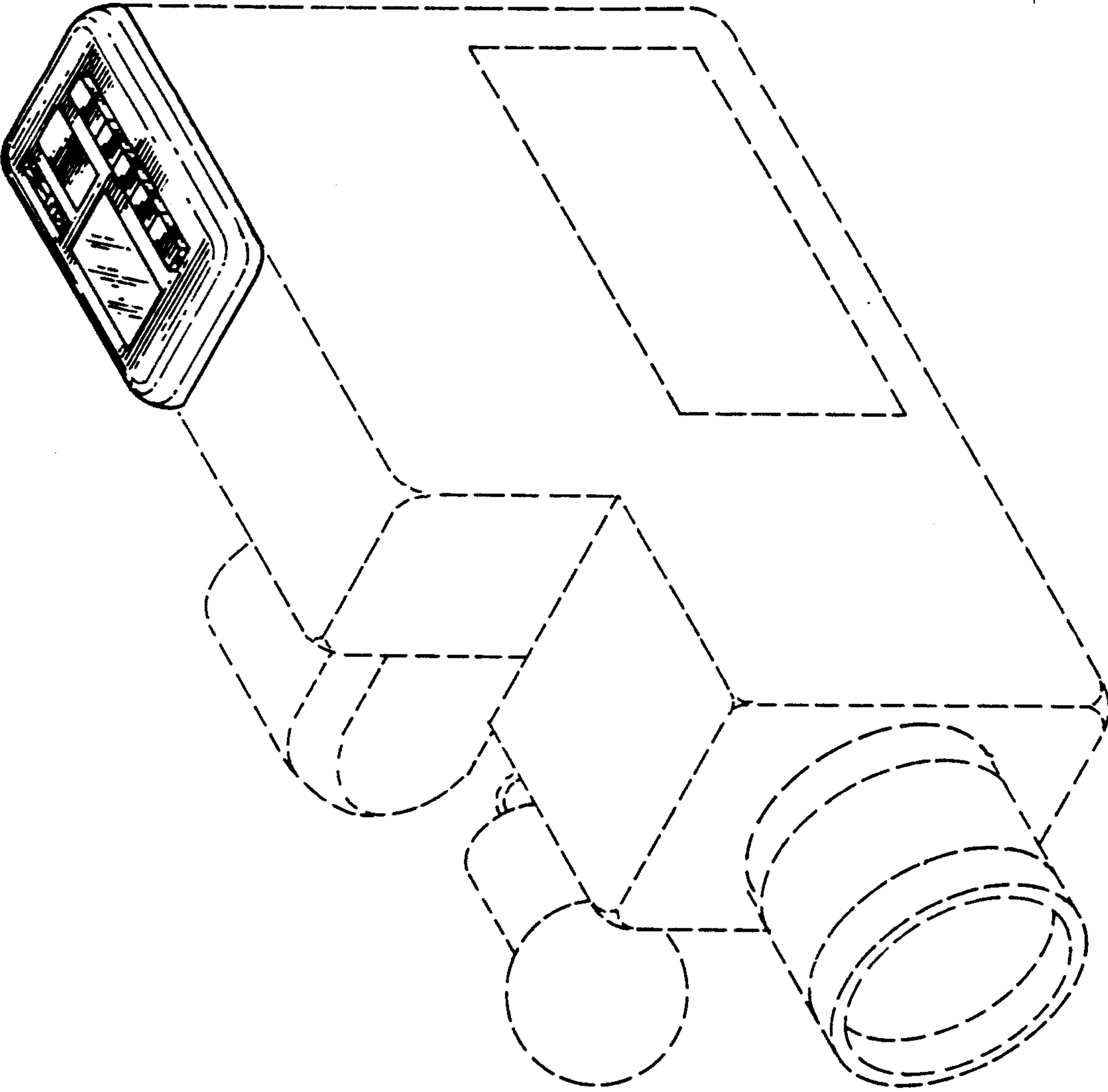

FIG. 1



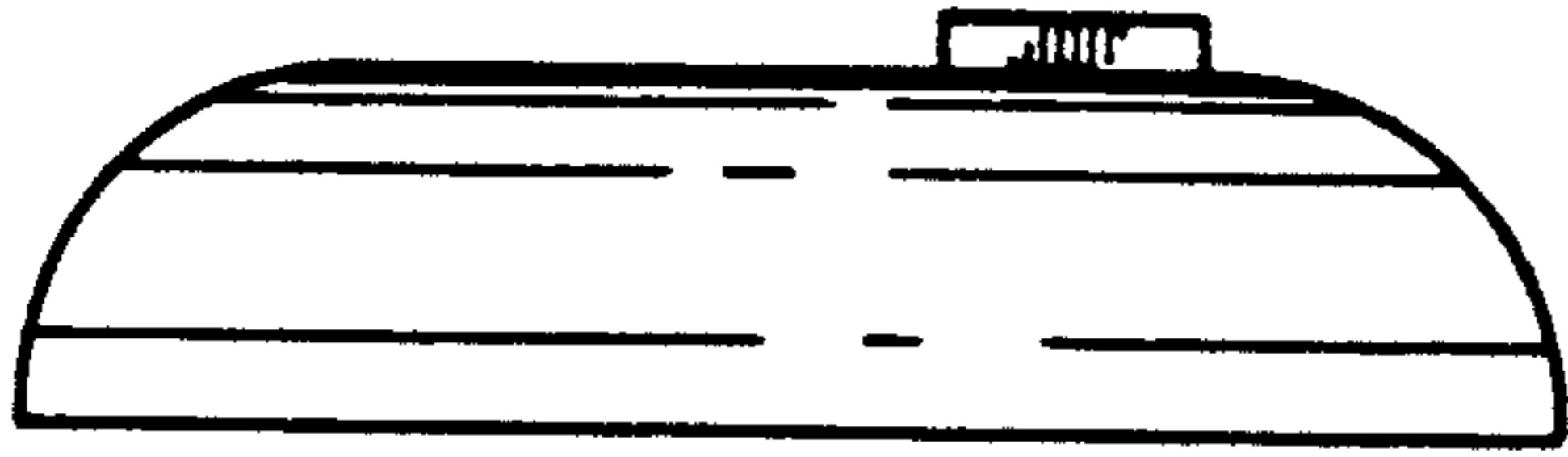

FIG. 2

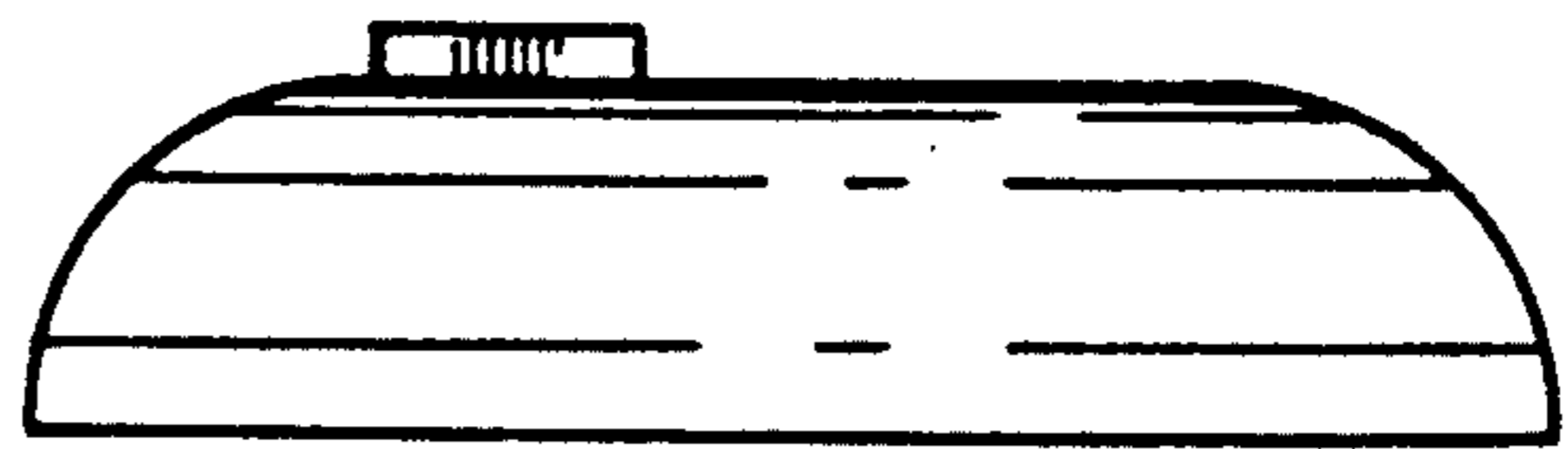

FIG. 3

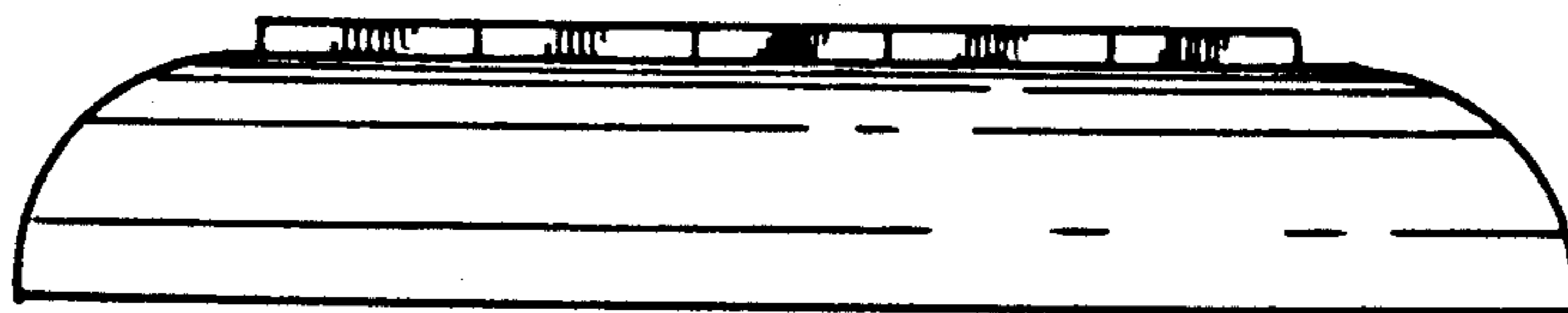

FIG. 4

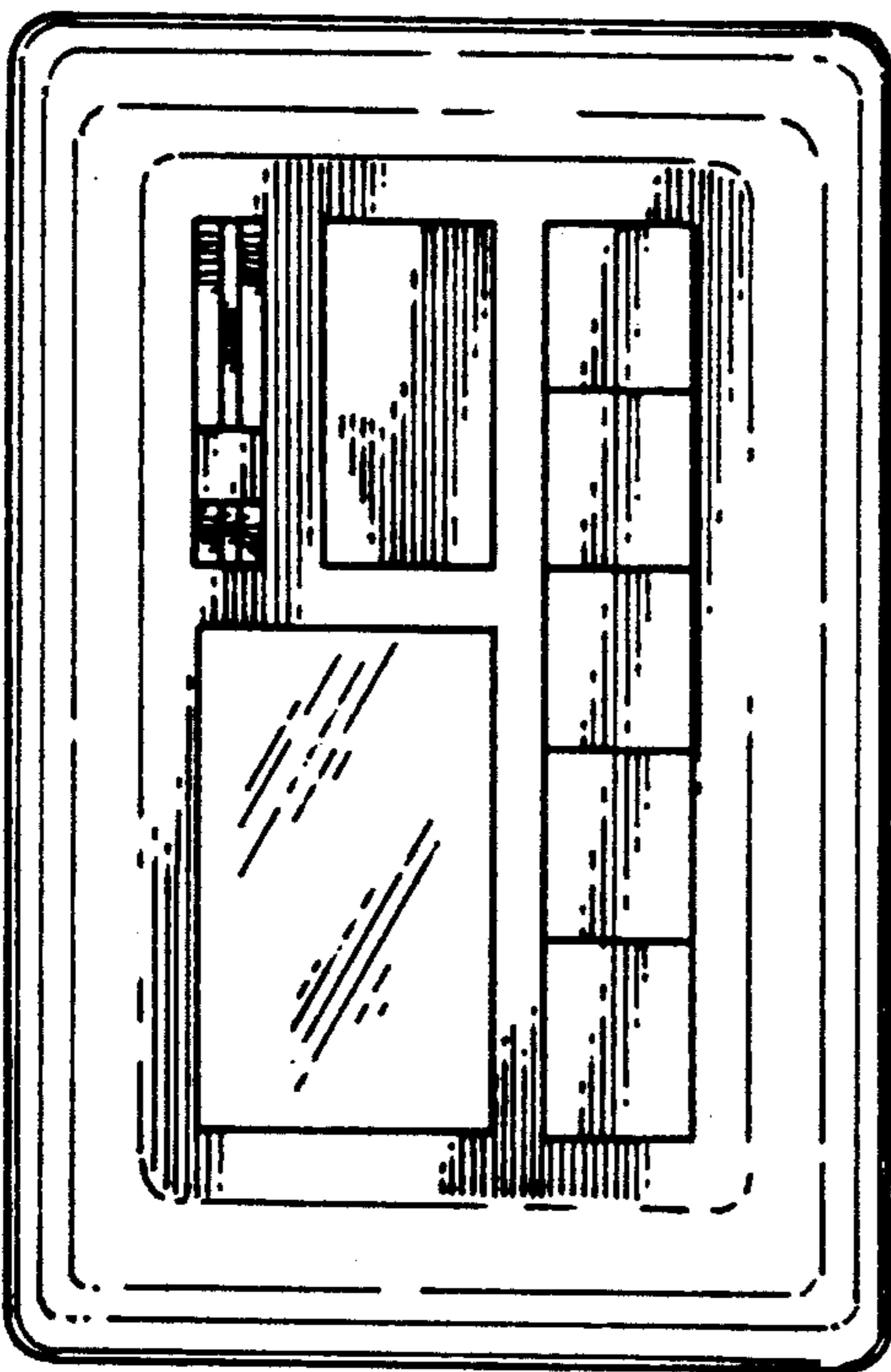

FIG. 5

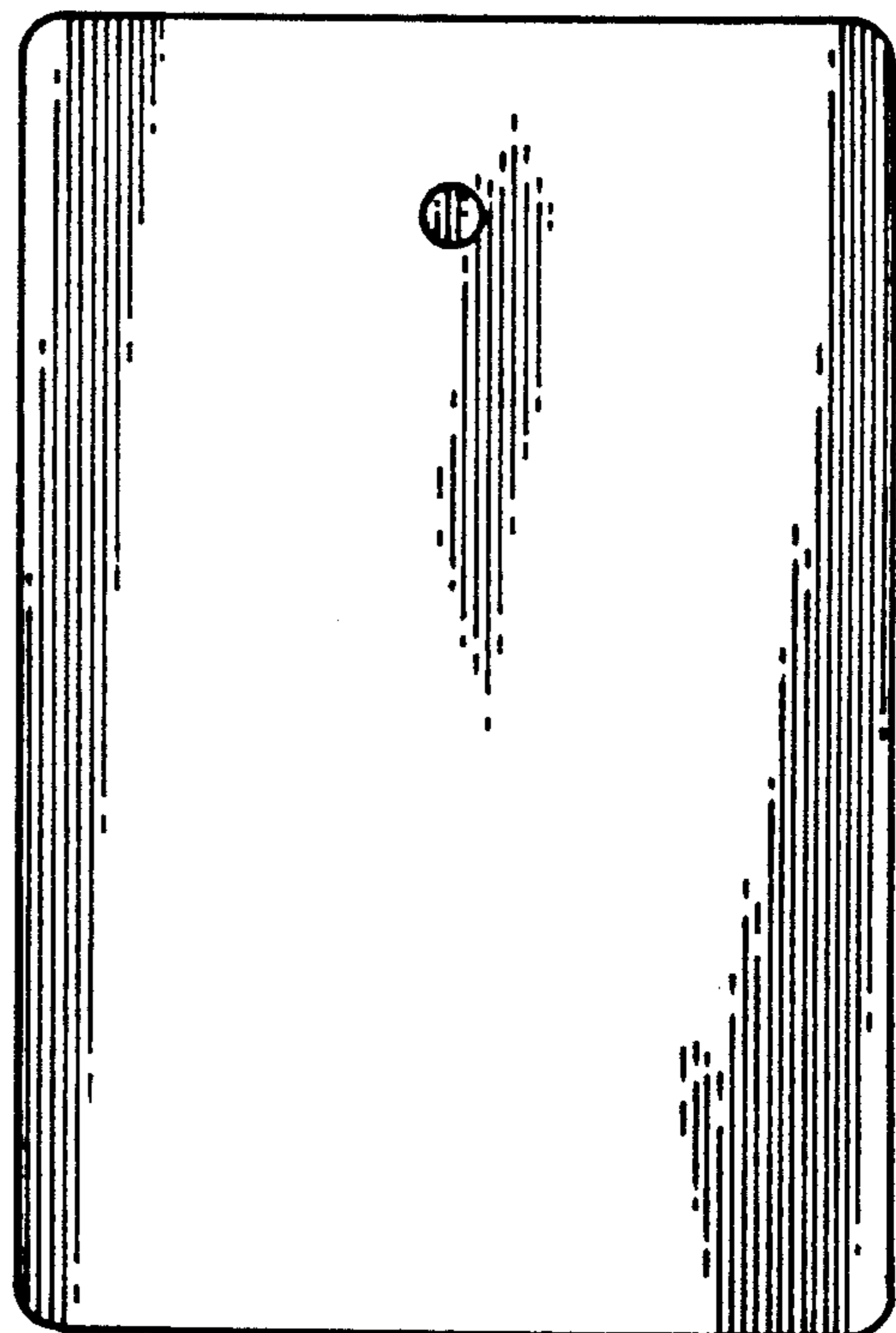

FIG. 6